



Industrial refrigeration and climate control

S Y S T E M S

GENERAL CATALOGUE

MADE IN ITALY



texaindustries.com





FOR ALL **THERMAL MANAGEMENT** REQUIREMENTS

AIR CONDITIONING RANGE



REFRIGERATION RANGE



All efforts have been made to provide accurate data and descriptions. However, due to our continuous development and improvement of our products, all information in this catalogue is subject to change without notice.

AIR CONDITIONING RANGE



SKY

Door- or wall-mount air conditioners

22

FLY

Door- or wall-mount air conditioners

30

EGO

Door- or wall-mount air conditioners

44

DEK

Roof-mount air conditioners

68

EMO

Wall-mount air conditioners for outdoor applications

84

BLU-BIT

Air-water heat exchangers

104

MIX

Air-air heat exchangers

120

FAN

Ventilation units with filter

128

DLK

Roof-mount fans

146

WID

Anti-condensation heaters

154



REFRIGERATION RANGE



TCW

Industrial water chillers

192

LCW

Negative temperature liquid chillers

216

TCO

Industrial oil chillers

226

TCU

Industrial chillers for contaminated or dirty fluids

244

TCI

Immersion coil chillers

252

SAW

Water-air heat exchangers

258

TTW

Temperature controllers

266

AIR CONDITIONING ACCESSORIES

164

REFRIGERATION ACCESSORIES (TEXA FLUID)

272





YESTERDAY - A 50-year history

Pavarini Components

The TEXA Division industrial project was born from over half a century of experience in Pavarini Components S.p.A., a **leading Italian company in the mechanical/hydraulic components sector.**

The TEXA Division took shape and developed during the 2000s, designing and manufacturing air conditioning and refrigeration systems for industrial applications entirely within Italy.

TODAY - Side by side with your company

texa industries

Today we are writing a new chapter as we head into the future with our new company, **texa industries** s.r.l. This catalogue has come about in part thanks to your special applications, from the passion of our engineers who worked to create them and of all those who work alongside **texa industries**, proposing **and implementing technologically advanced, high-performance solutions for all your industrial cooling needs.**

Our heartfelt thanks go out to all of you for the wonderful opportunity allowing us to create the huge range of products contained in this new catalogue.

*The **texa industries** Team*

A GLOBAL PARTNER

For all industrial cooling requirements

Our company is one of the few in Europe able to design and manufacture, using entirely Italian technology, **a complete range of air conditioning and industrial refrigeration solutions**, thus being for its customers a unique and complete partner for all thermal management requirements.

MADE IN ITALY

texa industries is a proud example of an Italian manufacturing company, and its solutions are distinguished by high quality standards and ease of use, in tune with its customers' needs

AN INTERNATIONAL PRESENCE

texa industries has a presence in 22 different countries spread over five continents, through a specialised expert distribution network. We also boast an international network of technicians and engineers who work to provide an effective support service throughout the world.

CUSTOM PRODUCTS

Our company offers a highly structured product catalogue; despite this, **texa industries** bases its business on providing dedicated solutions and custom designs to meet customers' specific requirements.



**LASER
TECHNOLOGY**

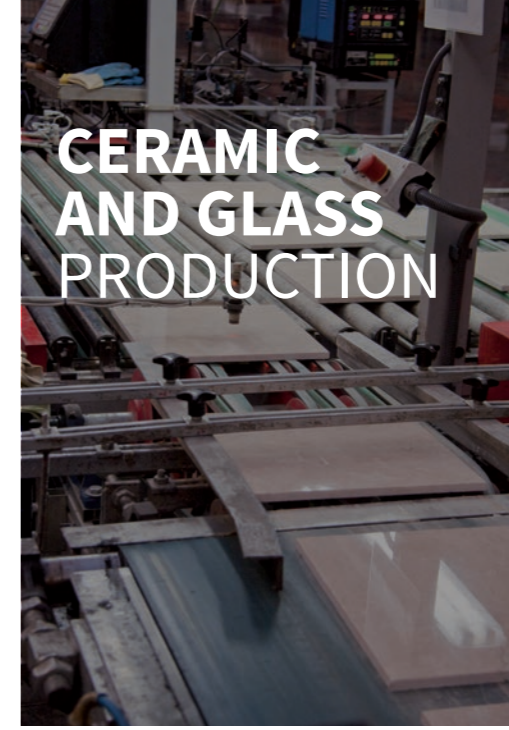

**CERAMIC
AND GLASS
PRODUCTION**



**FOOD &
BEVERAGE**

MARKET AREAS

A solution for all industrial cooling needs

Thanks to the wide range and quality of its products, **texa industries** has long-standing experience with a diverse range of leaders in many industrial sectors.

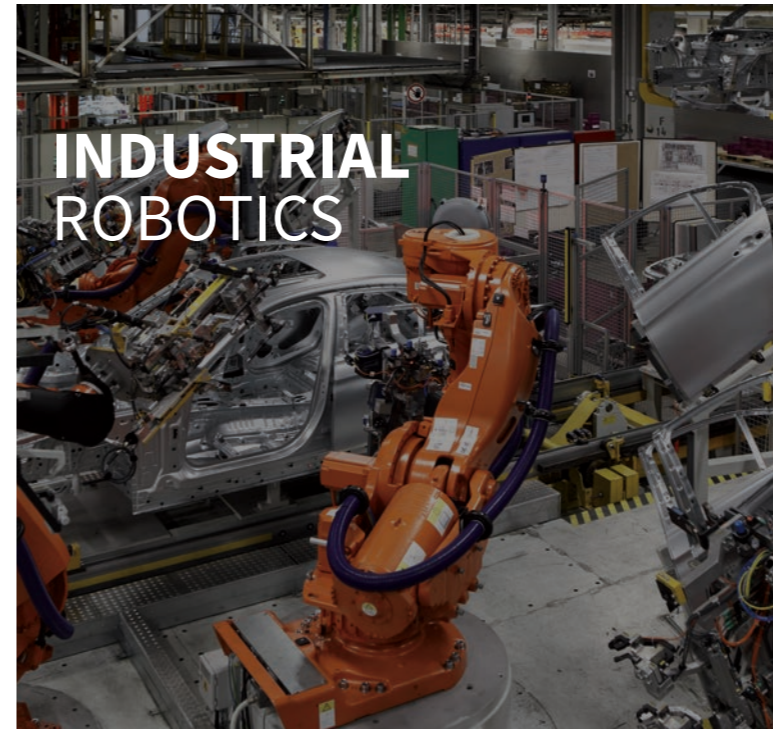

**INDUSTRIAL
ROBOTICS**



**PHARMACEUTICAL
INDUSTRY**



**MECHANICAL
ENGINEERING**



**TEXTILE
PRODUCTION**

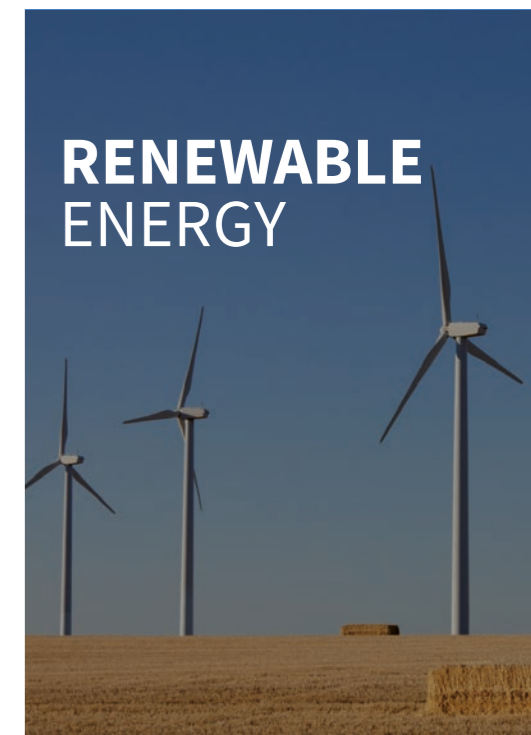

**RENEWABLE
ENERGY**

CERTIFICATIONS

Quality guarantee

The reliability and safety of **texa industries'** products are guaranteed by international certifications. The other quality standards and strict checks throughout the production chain make **texa industries'** products easy to use and widely recognised in all international markets.

COMPANY CERTIFICATION ISO 9001 - TÜV

The company is certified according to the stringent standards of organisational efficiency and product quality, minimising waste, avoiding errors and increasing productivity.



PRODUCT CERTIFICATION CE

texa industries products conform with the safety requirements set forth in *European Union directives*.



PRODUCT CERTIFICATION UL

The UL mark is the most recognised product marking related to safety accepted in the *United States and Canada*.



ENERGY SAVINGS

An important commitment to the environment and your company

Saving energy and protecting the environment have always been key goals for **texa industries**. This philosophy starts out with our attentive and responsible design, and includes the search for increasingly efficient production systems right through to the choice of and use of the very latest components.



REFINED DESIGN

The engineering of **texa industries** products is carried out by paying maximum attention to the reduction of consumption and respect for the environment



COST SAVINGS

The purchase of **texa industries** products guarantees a notable reduction in management costs and a significant increase in return on investment



HIGH-QUALITY EQUIPMENT

texa industries selects and uses only the latest generation components with high energy efficiency





AIR CONDITIONING RANGE



AT THE HEART OF TECHNOLOGY

There are numerous reasons to choose a **texa industries** cooling system

Listening to our customers, in addition to our extensive experience in the industrial sector, has allowed us to create a complete range of air conditioning systems suitable for all types of indoor and outdoor applications. Our strong product engineering has allowed us to standardise and include many previously optional extras as standard equipment throughout the range.

OUTDOOR APPLICATIONS

A range of specific air conditioning units for outdoor applications, the cataphoresis treatment of the condensing coil and the IP54-rated protection of all electrical components make this product reliable in all atmospheric conditions.

EASE OF INSTALLATION FILTER

The simple and ergonomic design of our air conditioning units allows installation and filter maintenance through a simple side housing, without the need to remove mechanical components.

DIE-CUT SEALS

The die-cut seal supplied as standard provides an easy and precise coupling between the air conditioner and the cabinet, also providing an IP55 rating inside the cabinet, one of the highest available on the market.



FLEXIBLE INSTALLATION

Unique in their field, designed specifically to meet standardisation requirements, a single drilling template, five cooling power ratings available and freedom of cabinet installation – external, semi-recessed or recessed installation – without the use of additional accessories.

REDUCED MAINTENANCE COSTS

All our air conditioning units feature a hydrophilic treatment on the condensing coil. This particular production process guarantees a longer life for the product and doubled effectiveness against fouling by dust or oil in suspension, significantly reducing scheduled maintenance requirements.

THERMOSTAT WITH DIGITAL DISPLAY

Powerful, reliable and standard on all ranges (with the exception of the Outdoor range), it provides an easy-to-read view of the set temperature, and allows multiple safety alarms to be managed. It also allows Master-Slave operation of two air conditioning units in the same cabinet simply by setting a parameter.

ANTI-CONDENSATION EVAPORATION SYSTEM

Standard on all vertical air conditioning units above 600W, this dissipation system saves energy as it draws no power, eliminating condensate without the need to channel it externally.

CONDENSATE DRAIN

Safety first! All air conditioners are equipped with an external condensate drain, ensuring the safety of the systems in any and all situations.



ITEM CODE FORMATION

POSITION	1-3	4-5	6	7	8	9	10-14
AIR CONDITIONER CODING	EGO	10	B	T	1	B	00000

1	2	3	Machine type
S	K	Y	Door- or wall-mount air conditioners
F	L	Y	Door- or wall-mount air conditioners
E	G	O	Door- or wall-mount air conditioners
D	E	K	Roof-mount air conditioners
E	M	O	Wall-mount air conditioners for outdoor applications
B	L	U	Air-water heat exchangers for door or wall installation
B	I	T	Air-water heat exchangers for roof installation
M	I	X	Air-air heat exchangers
F	A	N	Ventilation units with filter
F	I	L	Grilles with filter
D	L	K	Roof-mount fans
D	L	R	Roof-mount natural ventilation units
W	I	D	Anti-condensation heaters

POSITION 1-3 Product Name

4	5	Unit Size
-	-	

POSITION 4-5

6	Standard voltage	
	Nominal voltage	Voltage range
B	230 V 1~ 50-60 Hz	[210-250 V 1~ 50-60 Hz]
C	115 V 1~ 50-60 Hz	[105-125 V 1~ 50-60 Hz]
G	400/440 V 2~ 50-60 Hz	[380-420 V 50-60 Hz/420-460 V 50-60 Hz]
H	400 V 3~ 50 Hz/460 V 3~ 60 Hz	[380-420 V 3~ 50 Hz/440-480 V 3~ 60 Hz]
K	400/460 V 2~ 50-60 Hz	[380-420 V 50-60 Hz/440-480 V 50-60 Hz]
L	400 V 3~ 50-60 Hz	[380-420 V 3~ 50 Hz/400-440 V 3~ 60 Hz]
M	400 V 3~ 50 Hz	[380-420 V 3~ 50 Hz]
N	460 V 3~ 60 Hz	[440-480 V 3~ 60 Hz]
U	24 V DC	[20-28 V DC]
V	48 V DC	[40-56 V DC]
X	Special voltage or lack of power supply	
Z	110-250 V AC/DC	

POSITION 6

7	Control and regulation
M	Electromechanical thermostat (SKY-FLY-EGO-DEK-EMO)
T	Electronic thermostat (SKY-FLY-EGO-DEK)
X	No regulation device (SKY-FLY-EGO-DEK-MIX-DLK-DLR-BLU-BIT)
V	Model fitted with thermostat and solenoid valve (BLU-BIT)
L	Model fitted with level switch and solenoid valve (BLU-BIT)
F	Model fitted with thermostat, level switch and solenoid valve (BLU-BIT)

POSITION 7 SKY-FLY-EGO-DEK-EMO-MIX-DLK-DLR-BLU-BIT models

7	Ventilation and filtration
H	High-filtration filter + reversible cabinet ext. - int. flow fan (FAN)
N	Standard filter + reversible cabinet ext. - int. flow fan (FAN)
L	With fan (WID)
X	No ventilation device (WID)

POSITION 7 FAN-FIL-WID models

8	Certification, filtration and installation	
0	CE	Flexible installation (SKY-FLY-EGO-MIX)
1	CE	External installation (EGO-EMO)
F	CE	Flexible installation + PU filter (SKY-FLY-EGO)
E	CE	External installation + PU filter (EGO-EMO)
M	CE	Flexible installation + metal filter (SKY-FLY-EGO)
N	CE	External installation + metal filter (EGO-EMO)
U	UL US	Flexible installation (FLY-EGO)
V	UL US	External installation (EGO)
K	UL US	Flexible installation + PU filter (FLY-EGO)
J	UL US	External installation + PU filter (EGO)
W	UL US	Flexible installation + metal filter (FLY-EGO)
Y	UL US	External installation + metal filter (EGO)

POSITION 8 SKY-FLY-EGO-EMO-MIX models

8	Certification, filtration and installation	
0	CE	External installation (DEK-BIT-BLU)
F	CE	External installation + PU filter (DEK)
M	CE	External installation + metal filter (DEK)
U	UL US	External installation (DEK-BLU)
K	UL US	External installation + PU filter (DEK)
W	UL US	External installation + metal filter (DEK)

POSITION 8 DEK-BIT-BLU models

8	Certification	
0	CE	
U	UL US	

POSITION 8 FAN-FIL-DLK-DLR-WID models

9	Colour
A	RAL 7032 embossed effect
B	RAL 7035 embossed effect
D	RAL 6011 embossed effect
F	RAL 7032 gloss
L	RAL 6011 gloss
Q	RAL 7035 gloss
9	Stainless steel

POSITION 9

9	Size and regulation
X	Standard size without thermostat
C	Compact size without thermostat
T	Standard size with thermostat
P	Standard size with protected surfaces

POSITION 9 WID models

POSITION 10-14 Progressive numbering only for special versions

SKY

Door- or wall-mount air conditioners

Maximum flexibility of installation combined with excellent aesthetic integration makes SKY the **texa industries** solution which meets the needs of even the most demanding users.



POWER OUTPUTS

The available power outputs range from 1050 to 2050 W.

FLEXIBILITY OF INSTALLATION

The units can be installed outside the cabinet (external) or integrated (recessed or semi recessed), without the need for additional installation accessories. This feature, made possible by the modular structure of the units, leaves users free to choose the installation type without any restrictions.

ATTRACTIVE APPEARANCE

The grille is made of extremely tough, self-extinguishing impact-resistant ABS, which meets UL94 V0 requirements. The attractive design of the grille provides a positive aesthetic impact which supplements and improves the look of the cabinet.

ELECTRONIC THERMOSTAT

All **texa industries** air conditioning systems are equipped with electronic thermostat as standard.

QUICK INSTALLATION

Installation is very quick by simply drilling the cabinet panel and fastening systems which are included in the air conditioner package. This features provisions for the electrical connections to be made quickly and safely using fast connectors inserted in the rear of the unit.

IDEAL COOLING FOR THE UNIT

The air inside the cabinet is taken in from the upper part of the cabinet, cooled inside the air conditioner and directed back into the cabinet with a high-speed flow directed towards the bottom. This ensures both optimum cooling of the entire cabinet and the prevention of hot points in the electronic components.

REDUCED MAINTENANCE

All units are equipped with heat exchange surfaces designed to prevent clogging by solid contaminants present in the ambient air. They maintain high levels of efficiency even in demanding environmental conditions, drastically reducing maintenance requirements and thus allowing the air conditioner to operate without an external air filter.

OPTIMISED PROTECTION OF THE CABINET

Thanks to the special internal configuration, which separates the external and internal air flows in a sealed manner, and the self-adhesive coupling gasket, SKY air conditioners allow the cabinet to retain an IP54 rating.

ENVIRONMENTAL PROTECTION

Reduction of noise levels is a precise criterion aimed for when developing SKY air conditioners. They have been designed to minimise disturbance from noise and thus help provide quiet working environments. To help protect the environment, all our air conditioners use R134a CFC-free refrigerant, which does not damage the ozone layer.

SUPPLY VOLTAGE

SKY air conditioners are available for the most common AC voltages: 230V single phase, 400-440V two phase (for concatenated voltage power supply when neutral is not present), 115V single phase, 400V three phase, all in 50-60 Hz dual frequency. On request, versions for voltages not present in the catalogue can be produced for orders of sufficient quantities.

PAINT/COATING

The standard colour is RAL 7035 textured. The coating is epoxy powder coating. Non-standard colours and stainless-steel versions are available on request.

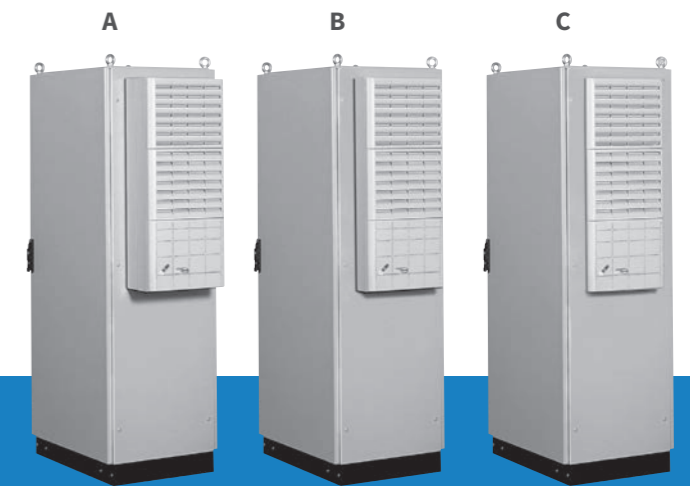

Three installation options:

A External - **B** Semi-recessed - **C** Internal



Application tips

- When choosing an air conditioner, keep a margin of safety of at least 10% for the power output, taking the most demanding conditions of operation into account.
- Seal the cabinet well. Any cracks or other openings would significantly reduce the efficiency of the air conditioner and produce excessive amounts of condensate.
- The air conditioner may be installed on the door or the wall, but always in the highest possible position in order to ensure that air is taken in from the top part of the cabinet, where there is a high temperature area.
- The air conditioner is factory set to 35°C, the optimum temperature for most applications. Unless strictly necessary, avoiding lowering this temperature because it would reduce the efficiency of the air conditioner and cause excessive condensate production.
- Try to facilitate the air flow inside the electrical cabinet when designing the layout of the components. Avoid blocking the air inlet or outlet with components installed too close together. Any components with internal ventilation of their own must have their air flow arranged so as to not impede the air flow of the air conditioner.
- Disable the air conditioner if the cabinet doors are opened to prevent excessive condensate production. Install a limit switch on the door for this purpose.
- The air conditioner power supply line must be protected with a time delay fuse or circuit breaker of suitable size on the basis of the unit's technical data.

SKY10

Door- or wall-mount air conditioners

COOLING CAPACITY

1050 W



Features	UoM	SKY10BT0B	SKY10CT0B	SKY10GT0B
Cooling capacity EN14511 - A35A35	W	1050	1050	1050
Cooling capacity EN14511 - A35A50	W	860	860	860
Power supply	V ~ Hz	230 1~ 50-60	115 1~ 50-60	400/440 2~ 50-60
Width	mm	400	400	400
Height	mm	950	950	950
Depth	mm	233	233	233
Max current	A	3.1	6.3	1.9
Inrush current	A	10.5	23	8
T Fuse	A	6	10	4
Power draw EN14511 - A35A35	W	570	590	590
Power draw EN14511 - A35A50	W	650	670	670
Operating cycle	-	100%	100%	100%
Electrical connection	-	4-pin plug	4-pin plug	4-pin plug
R134a Refrigerant	kg	0.3	0.3	0.3
Max refrigeration circuit pressure	bar	25	25	25
External air fan capacity	m ³ /h	860	860	860
Cabinet air fan capacity	m ³ /h	570	570	570
Internal temperature range	°C	20-46	20-46	20-46
Temperature regulation	-	Electronic thermostat, factory set to 35°C		
External temperature range	°C	20-55*	20-50	20-50
EN60529 ingress protection - cabinet side	-	IP54	IP54	IP54
EN60529 ingress protection - ambient side	-	IP34	IP34	IP34
Noise level	dB (A)	65	65	65
Weight	kg	37	39	39
Colour	-	RAL 7035 embossed effect		
Conformity	-	CE	CE	CE

Accessories	
Pack of 5 fabric air filters	C15000181
Pack of 1 metal air filter	C15000182
External stainless-steel framework	
Coating in non-standard colour	

* 50 °C at 60 Hz

Performance

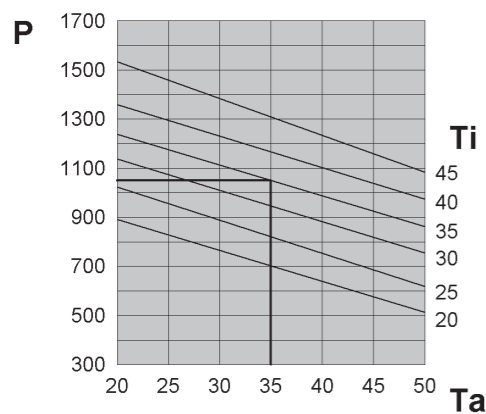

■ P = Cooling capacity (W)
 ■ Ta = Ambient Temperature (°C)
 ■ Ti = Internal cabinet temperature (°C)

Dimensions

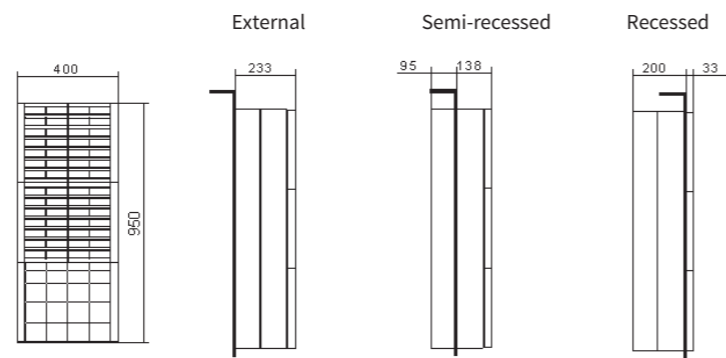

SKY15

Door- or wall-mount air conditioners

COOLING CAPACITY

1550 W



Features	UoM	SKY15BT0B	SKY15CT0B	SKY15GT0B
Cooling capacity EN14511 - A35A35	W	1550	1550	1550
Cooling capacity EN14511 - A35A50	W	1200	1200	1200
Power supply	V ~ Hz	230 1~ 50-60	115 1~ 50-60	400/440 2~ 50-60
Width	mm	400	400	400
Height	mm	950	950	950
Depth	mm	233	233	233
Max current	A	5.3	12.9	2.9
Inrush current	A	18	39	11
T Fuse	A	10	20	6
Power draw EN14511 - A35A35	W	880	900	900
Power draw EN14511 - A35A50	W	980	1000	1000
Operating cycle	-	100%	100%	100%
Electrical connection	-	4-pin plug	4-pin plug	4-pin plug
R134a Refrigerant	kg	0.44	0.44	0.44
Max refrigeration circuit pressure	bar	25	25	25
External air fan capacity	m ³ /h	1050	1050	1050
Cabinet air fan capacity	m ³ /h	570	570	570
Internal temperature range	°C	20-46	20-46	20-46
Temperature regulation	-	Electronic thermostat, factory set to 35°C		
External temperature range	°C	20-55*	20-50	20-50
EN60529 ingress protection - cabinet side	-	IP54	IP54	IP54
EN60529 ingress protection - ambient side	-	IP34	IP34	IP34
Noise level	dB (A)	65	65	65
Weight	kg	38	40	40
Colour	-	RAL 7035 embossed effect		
Conformity	-	CE	CE	CE

Accessories	
Pack of 5 fabric air filters	C15000181
Pack of 1 metal air filter	C15000182
External stainless-steel framework	
Coating in non-standard colour	

* 50 °C at 60 Hz

Performance

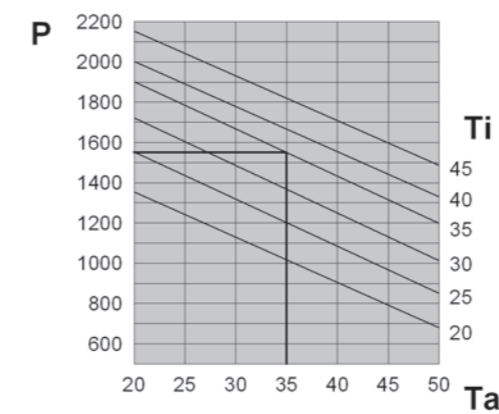

■ P = Cooling capacity (W)
 ■ Ta = Ambient Temperature (°C)
 ■ Ti = Internal cabinet temperature (°C)

Dimensions

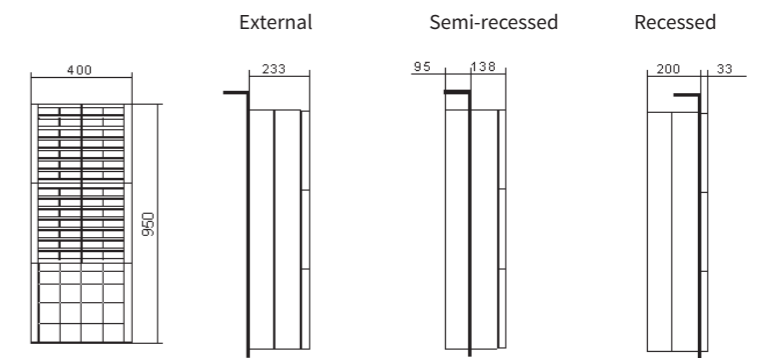

SKY20

Door- or wall-mount air conditioners

COOLING CAPACITY

2050 W



Features	UoM	SKY20BT0B	SKY20CT0B	SKY20LT0B
Cooling capacity EN14511 - A35A35	W	2050	2050	2050
Cooling capacity EN14511 - A35A50	W	1560	1560	1560
Power supply	V ~ Hz	230 1~ 50-60	115 1~ 50-60	400 3~ 50-60
Width	mm	400	400	400
Height	mm	1265	1265	1265
Depth	mm	236	236	236
Max current	A	6.5	13.3	2.5
Inrush current	A	24	48	10
T Fuse	A	10	20	6
Power draw EN14511 - A35A35	W	1080	1110	970
Power draw EN14511 -A35A50	W	1290	1310	1150
Operating cycle	-	100%	100%	100%
Electrical connection	-	4-pin plug	4-pin plug	4-pin plug
R134a Refrigerant	kg	0.60	0.60	0.75
Max refrigeration circuit pressure	bar	25	25	25
External air fan capacity	m ³ /h	1050	1050	1050
Cabinet air fan capacity	m ³ /h	860	860	860
Internal temperature range	°C	20-46	20-46	20-46
Temperature regulation	-	Electronic thermostat, factory set to 35°C		
External temperature range	°C	20-55*	20-50	20-50
EN60529 ingress protection - cabinet side	-	IP54	IP54	IP54
EN60529 ingress protection - ambient side	-	IP34	IP34	IP34
Noise level	dB (A)	65	65	65
Weight	kg	60	67	62
Colour	-	RAL 7035 embossed effect		
Conformity	-	CE	CE	CE

Accessories	
Pack of 5 fabric air filters	C15000181
Pack of 1 metal air filter	C15000182
External stainless-steel framework	
Coating in non-standard colour	

* 50 °C at 60 Hz

Performance

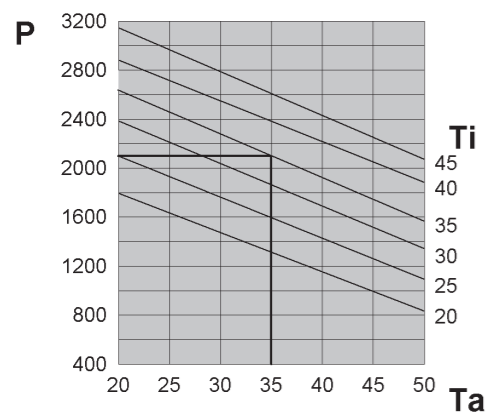

■ P = Cooling capacity (W)
 ■ Ta = Ambient Temperature (°C)
 ■ Ti = Internal cabinet temperature (°C)

Dimensions

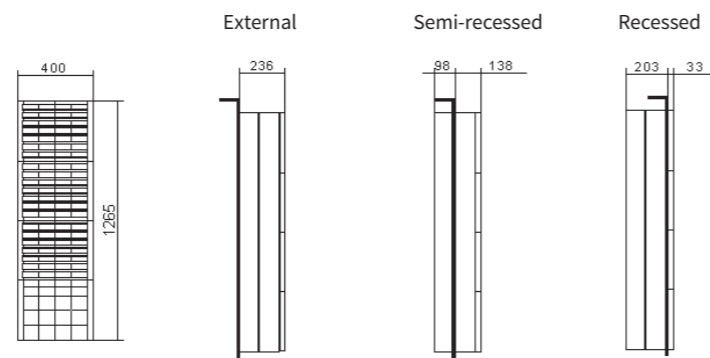

FLY

Door- or wall-mount air conditioners

A revolutionary installation system combined with an attractive design with significantly reduced depth make FLY air conditioners perfect for any automation panels.



FLY

Door- or wall-mount air conditioners

WIDE RANGE OF POWER OUTPUTS

The available power outputs range from 1100 to 3200 W, covering most electrical cabinet cooling requirements in an extremely compact size.

FLEXIBILITY OF INSTALLATION

The units can be installed outside the cabinet (external) or integrated (recessed or semi recessed), without the need for additional installation accessories. This feature, made possible by the modular structure of the units, leaves users free to choose the installation type without any restrictions. A SINGLE DRILLING TEMPLATE FOR THE WHOLE RANGE

ATTRACTIVE APPEARANCE

The attractive design of the grille provides a positive aesthetic impact which supplements and improves the look of the cabinet.

ELECTRONIC THERMOSTAT

All **texa industries** air conditioning systems are equipped with electronic thermostat as standard.

QUICK INSTALLATION

Installation is very quick by simply drilling the cabinet panel and fastening systems which are included in the air conditioner package. This features provisions for the electrical connections to be made quickly and safely using fast connectors inserted in the rear of the unit.

IDEAL COOLING FOR THE UNIT

The air inside the cabinet is taken in from the upper part of the cabinet, cooled inside the air conditioner and directed back into the cabinet with a high-speed flow directed towards the bottom. This ensures both optimum cooling of the entire cabinet and the prevention of hot points in the electronic components.

REDUCED MAINTENANCE

All units are equipped with heat exchange surfaces designed to prevent clogging by solid contaminants present in the ambient air. The condensing coils are protected by a **HYDROPHILIC TREATMENT** which prevents dirt and corrosion. They maintain high levels of efficiency even in demanding environmental conditions, drastically reducing maintenance requirements and thus allowing the air conditioner to operate without an external air filter.

IP55 CABINET INGRESS PROTECTION

Thanks to the special internal configuration, which separates the external and internal air flows in a sealed manner, and the new self-adhesive coupling gasket, FLY air conditioners allow the cabinet to retain an IP55 rating.

ANTI-CONDENSATION EVAPORATION SYSTEM

FLY air conditioners are equipped with an **INTEGRATED CONDENSATE RECOVERY SYSTEM** which allows installation costs to be further reduced.

ENVIRONMENTAL PROTECTION

Reduction of noise levels is a precise criterion aimed for when developing FLY air conditioners. They have been designed to minimise disturbance from noise and thus help provide quiet working environments. To help protect the environment, these air conditioners use R134a CFC-free refrigerant, which does not damage the ozone layer.

SUPPLY VOLTAGE

FLY air conditioners are available for the most common AC voltages: 230V single phase, 400-460V two phase (for concatenated voltage power supply when neutral is not present). 400V three phase 50 Hz and 460 V three phase 60 Hz. On request, versions for voltages not present in the catalogue can be produced for orders of sufficient quantities.

PAINT/COATING

The standard colour is RAL 7035 textured. The coating is epoxy powder coating. Non-standard colours and stainless-steel versions are available on request.

CERTIFICATIONS

All FLY models are CE and UL certified in the standard supply voltages.

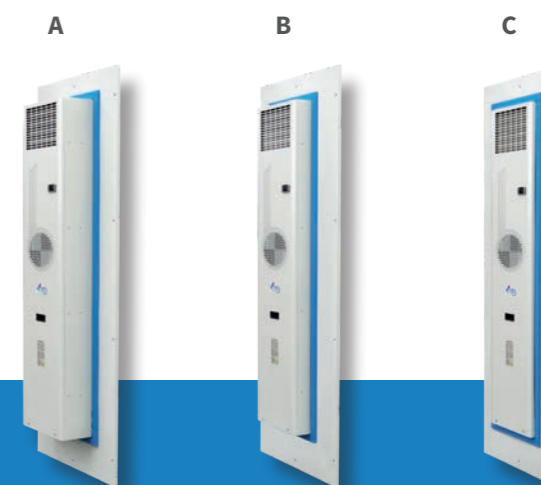

Three installation options:

A External - **B** Semi-recessed - **C** Internal



Application tips

- When choosing an air conditioner, keep a margin of safety of at least 10% for the power output, taking the most demanding conditions of operation into account.
- Seal the cabinet well. Any cracks or other openings would significantly reduce the efficiency of the air conditioner and produce excessive amounts of condensate.
- The air conditioner may be installed on the door or the wall, but always in the highest possible position in order to ensure that air is taken in from the top part of the cabinet, where there is a high temperature area.
- The air conditioner is factory set to 35°C, the optimum temperature for most applications. Unless strictly necessary, avoiding lowering this temperature because it would reduce the efficiency of the air conditioner and cause excessive condensate production.
- Try to facilitate the air flow inside the electrical cabinet when designing the layout of the components. Avoid blocking the air inlet or outlet with components installed too close together. Any components with internal ventilation of their own must have their air flow arranged so as to not impede the air flow of the air conditioner.
- Disable the air conditioner if the cabinet doors are opened to prevent excessive condensate production. Install a limit switch on the door for this purpose.
- The air conditioner power supply line must be protected with a time delay fuse or circuit breaker of suitable size on the basis of the unit's technical data.

FLY11

Door- or wall-mount air conditioners

COOLING CAPACITY

1100 W

Performance

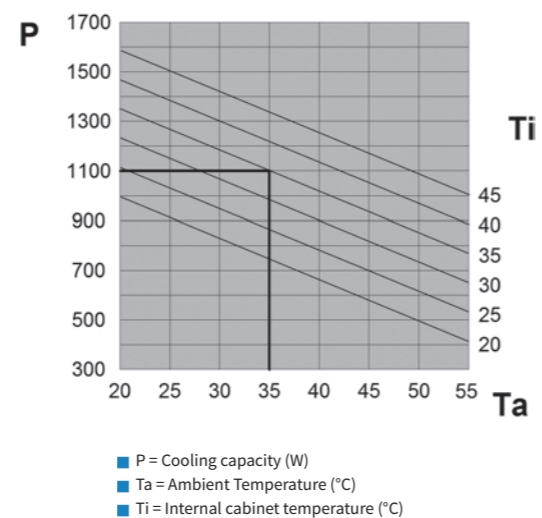

Dimensions

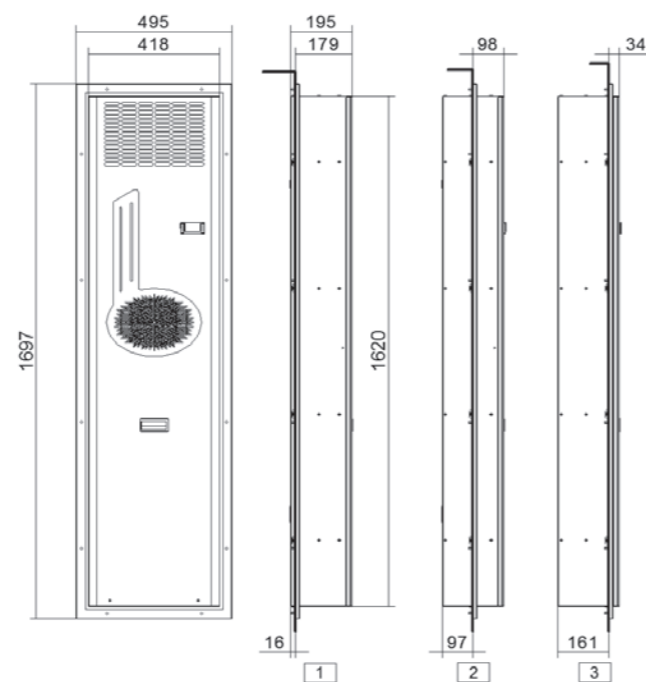

Features	UoM	FLY11BT0B	FLY11BTUB	FLY11KT0B	FLY11KTUB
Cooling capacity EN14511 - A35A35	W	1100	1100	1100	1100
Cooling capacity EN14511 - A35A50	W	860	860	860	860
Power supply	V ~ Hz	230 1~ 50-60	230 1~ 50-60	400/460 2~ 50-60	400/460 2~ 50-60
Width	mm	495	495	495	495
Height	mm	1697	1697	1697	1697
Depth	mm	195	195	195	195
Max current	A	6	6	3	3
Inrush current	A	21	21	8.5	8.5
T Fuse	A	10	10	5	5
Power draw EN14511 - A35A35	W	850	850	850	850
Power draw EN14511 - A35A50	W	980	980	980	980
Operating cycle	-	100%	100%	100%	100%
Electrical connection	-	4-pin plug	4-pin plug	4-pin plug	4-pin plug
R134a Refrigerant	kg	0.36	0.36	0.36	0.36
Max refrigeration circuit pressure	bar	28	28	28	28
External air fan capacity	m ³ /h	860	860	860	860
Cabinet air fan capacity	m ³ /h	860	860	860	860
Internal temperature range	°C	20-50	20-50	20-50	20-50
Temperature regulation	-	Electronic thermostat, factory set to 35°C			
External temperature range	°C	20-55	20-55	20-55	20-55
EN60529 ingress protection - cabinet side	-	IP55	IP55	IP55	IP55
EN60529 ingress protection - ambient side	-	IP34	IP34	IP34	IP34
Noise level	dB (A)	64	64	64	64
Weight	kg	57	57	59	59
Colour	-	RAL 7035 embossed effect			
Conformity	-	CE	CE	CE	CE

Accessories	
Pack of 5 fabric air filters	C15000181
Pack of 1 metal air filter	C15000182
External stainless-steel framework	
Coating in non-standard colour	

FLY15

Door- or wall-mount air conditioners

COOLING CAPACITY

1500 W

Performance

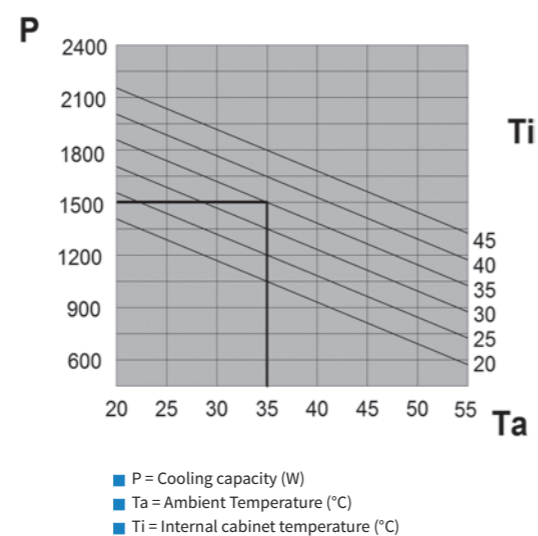

Dimensions

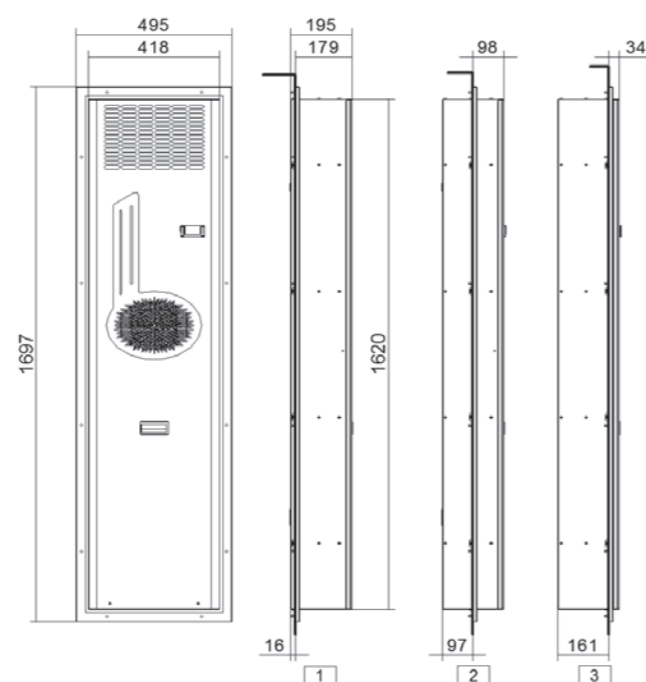

Features	UoM	FLY15BT0B	FLY15BTUB	FLY15KT0B	FLY15KTUB
Cooling capacity EN14511 - A35A35	W	1500	1500	1500	1500
Cooling capacity EN14511 - A35A50	W	1150	1150	1150	1150
Power supply	V ~ Hz	230 1~ 50-60	230 1~ 50-60	400/460 2~ 50-60	400/460 2~ 50-60
Width	mm	495	495	495	495
Height	mm	1697	1697	1697	1697
Depth	mm	195	195	195	195
Max current	A	6.3	6.3	3.5	3.5
Inrush current	A	24	24	10.5	10.5
T Fuse	A	10	10	6	6
Power draw EN14511 - A35A35	W	1020	1020	1020	1020
Power draw EN14511 -A35A50	W	1290	1290	1290	1290
Operating cycle	-	100%	100%	100%	100%
Electrical connection	-	4-pin plug	4-pin plug	4-pin plug	4-pin plug
R134a Refrigerant	kg	0.41	0.41	0.41	0.41
Max refrigeration circuit pressure	bar	28	28	28	28
External air fan capacity	m ³ /h	1050	1050	1050	1050
Cabinet air fan capacity	m ³ /h	860	860	860	860
Internal temperature range	°C	20-50	20-50	20-50	20-50
Temperature regulation	-	Electronic thermostat, factory set to 35°C			
External temperature range	°C	20-55	20-55	20-55	20-55
EN60529 ingress protection - cabinet side	-	IP55	IP55	IP55	IP55
EN60529 ingress protection - ambient side	-	IP34	IP34	IP34	IP34
Noise level	dB (A)	66	66	66	66
Weight	kg	59	59	61	61
Colour	-	RAL 7035 embossed effect			
Conformity	-	CE	CE	CE	CE

Accessories

Pack of 5 fabric air filters	C15000181
Pack of 1 metal air filter	C15000182
External stainless-steel framework	
Coating in non-standard colour	

FLY20

Door- or wall-mount air conditioners

COOLING CAPACITY

2000 W

Performance

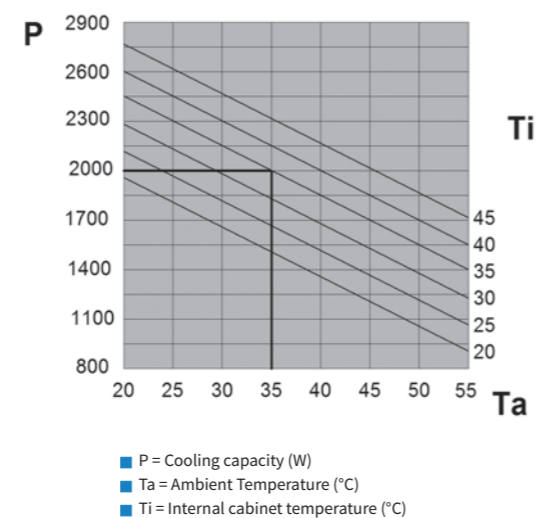

Dimensions

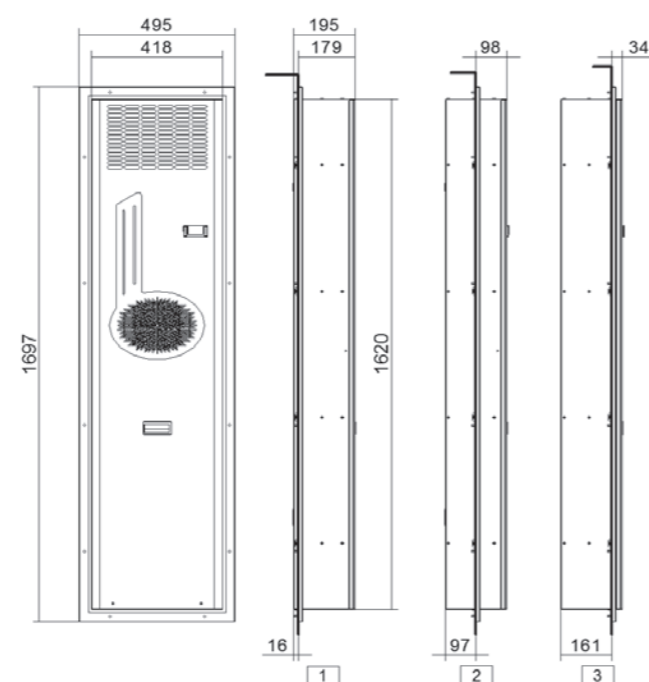

Features	UoM	FLY20BT0B	FLY20BTUB	FLY20HT0B	FLY20HTUB
Cooling capacity EN14511 - A35A35	W	2000	2000	2000	2000
Cooling capacity EN14511 - A35A50	W	1550	1550	1550	1550
Power supply	V ~ Hz	230 1~ 50-60	230 1~ 50-60	400 3~ 50/460 3~ 60	400 3~ 50/460 3~ 60
Width	mm	495	495	495	495
Height	mm	1697	1697	1697	1697
Depth	mm	195	195	195	195
Max current	A	6.5	6.5	3	3
Inrush current	A	27	27	10	10
T Fuse	A	11	11	6	6
Power draw EN14511 - A35A35	W	1290	1290	1410	1410
Power draw EN14511 - A35A50	W	1520	1520	1620	1620
Operating cycle	-	100%	100%	100%	100%
Electrical connection	-	4-pin plug	4-pin plug	4-pin plug	4-pin plug
R134a Refrigerant	kg	0.49	0.53	0.57	0.56
Max refrigeration circuit pressure	bar	28	28	28	28
External air fan capacity	m ³ /h	1050	1050	1050	1050
Cabinet air fan capacity	m ³ /h	860	860	860	860
Internal temperature range	°C	20-50	20-50	20-50	20-50
Temperature regulation	-	Electronic thermostat, factory set to 35°C			
External temperature range	°C	20-55	20-55	20-55	20-55
EN60529 ingress protection - cabinet side	-	IP55	IP55	IP55	IP55
EN60529 ingress protection - ambient side	-	IP34	IP34	IP34	IP34
Noise level	dB (A)	67	67	67	67
Weight	kg	67	67	69	69
Colour	-	RAL 7035 embossed effect			
Conformity	-	CE	CE	CE	CE

Accessories

Pack of 5 fabric air filters	C15000181
Pack of 1 metal air filter	C15000182
External stainless-steel framework	
Coating in non-standard colour	

FLY25

Door- or wall-mount air conditioners

COOLING CAPACITY

2500 W

Performance

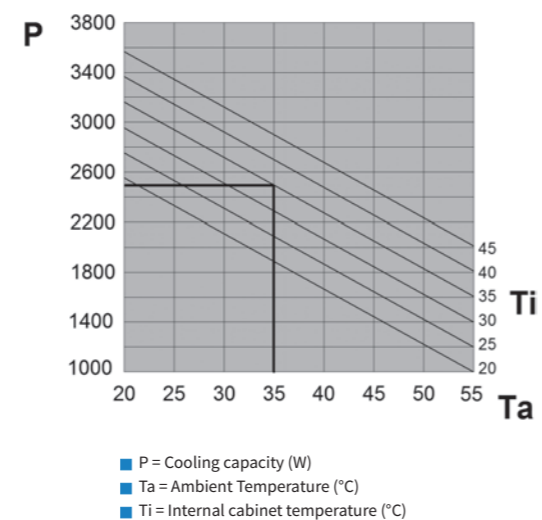

Dimensions

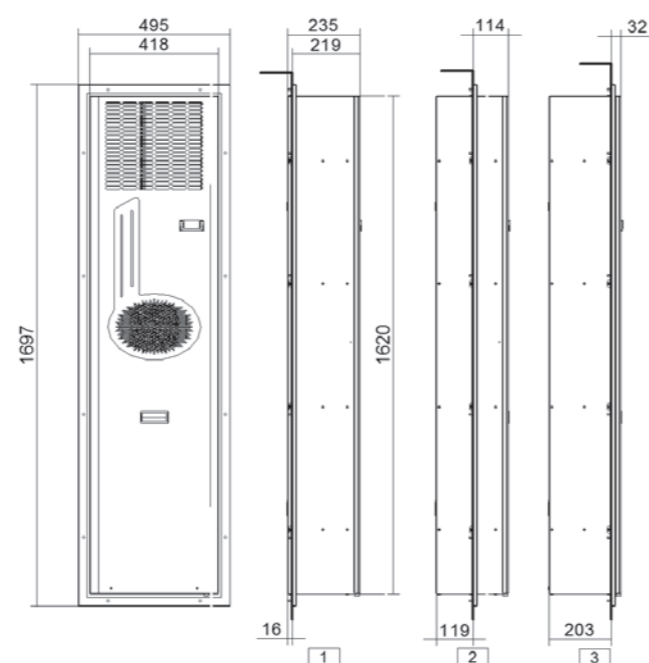

Features	UoM	FLY25BT0B	FLY25BTUB	FLY25HT0B	FLY25HTUB
Cooling capacity EN14511 - A35A35	W	2500	2500	2500	2500
Cooling capacity EN14511 - A35A50	W	1850	1850	1850	1850
Power supply	V ~ Hz	230 1~ 50-60	230 1~ 50-60	400 3~ 50/460 3~ 60	400 3~ 50/460 3~ 60
Width	mm	495	495	495	495
Height	mm	1697	1697	1697	1697
Depth	mm	235	235	235	235
Max current	A	10.5	10.5	3.5	3.5
Inrush current	A	35	35	14	14
T Fuse	A	13	13	7	7
Power draw EN14511 - A35A35	W	1640	1640	1690	1690
Power draw EN14511 - A35A50	W	1830	1830	1860	1860
Operating cycle	-	100%	100%	100%	100%
Electrical connection	-	4-pin plug	4-pin plug	4-pin plug	4-pin plug
R134a Refrigerant	kg	0.9	0.7	0.65	0.8
Max refrigeration circuit pressure	bar	28	28	28	28
External air fan capacity	m ³ /h	1450	1450	1450	1450
Cabinet air fan capacity	m ³ /h	1450	1450	1450	1450
Internal temperature range	°C	20-50	20-50	20-50	20-50
Temperature regulation	-	Electronic thermostat, factory set to 35°C			
External temperature range	°C	20-55	20-55	20-55	20-55
EN60529 ingress protection - cabinet side	-	IP55	IP55	IP55	IP55
EN60529 ingress protection - ambient side	-	IP34	IP34	IP34	IP34
Noise level	dB (A)	69	69	69	69
Weight	kg	80	80	82	82
Colour	-	RAL 7035 embossed effect			
Conformity	-	CE	CE	CE	CE

Accessories

Pack of 5 fabric air filters	C15000181
Pack of 1 metal air filter	C15000182
External stainless-steel framework	
Coating in non-standard colour	

FLY32

Door- or wall-mount air conditioners

COOLING CAPACITY

3200 W

Performance

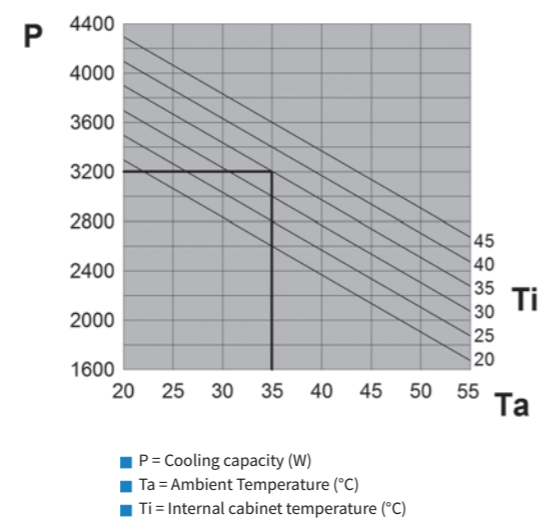

Dimensions

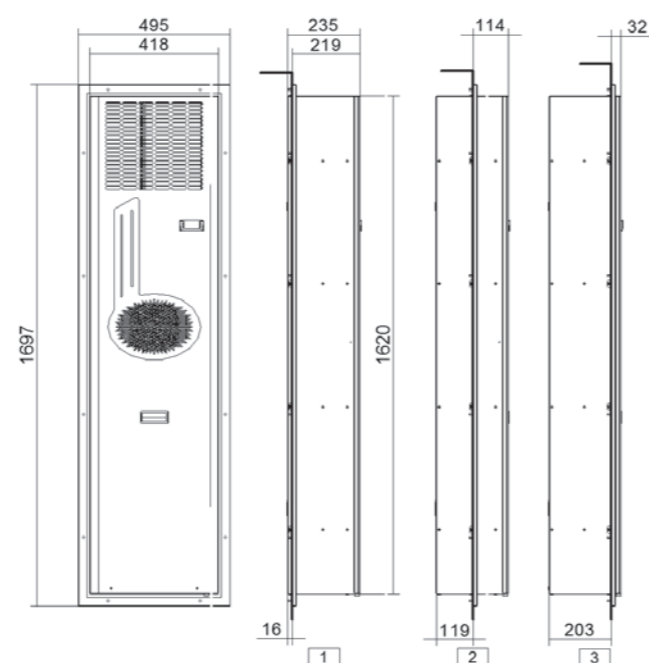

Features	UoM	FLY32BT0B	FLY32BTUB	FLY32HT0B	FLY32HTUB
Cooling capacity EN14511 - A35A35	W	3200	3200	3200	3200
Cooling capacity EN14511 - A35A50	W	2500	2500	2500	2500
Power supply	V ~ Hz	230 1~ 50-60	230 1~ 50-60	400 3~ 50/460 3~ 60	400 3~ 50/460 3~ 60
Width	mm	495	495	495	495
Height	mm	1697	1697	1697	1697
Depth	mm	235	235	235	235
Max current	A	12	12	4.5	4.5
Inrush current	A	39	39	18	18
T Fuse	A	15	15	8	8
Power draw EN14511 - A35A35	W	1920	1920	1980	1980
Power draw EN14511 - A35A50	W	2240	2240	2290	2290
Operating cycle	-	100%	100%	100%	100%
Electrical connection	-	4-pin plug	4-pin plug	4-pin plug	4-pin plug
R134a Refrigerant	kg	0.8	0.72	0.7	0.9
Max refrigeration circuit pressure	bar	28	28	28	28
External air fan capacity	m ³ /h	1450	1450	1450	1450
Cabinet air fan capacity	m ³ /h	1450	1450	1450	1450
Internal temperature range	°C	20-50	20-50	20-50	20-50
Temperature regulation	-	Electronic thermostat, factory set to 35°C			
External temperature range	°C	20-55	20-55	20-55	20-55
EN60529 ingress protection - cabinet side	-	IP55	IP55	IP55	IP55
EN60529 ingress protection - ambient side	-	IP34	IP34	IP34	IP34
Noise level	dB (A)	69	69	69	69
Weight	kg	81	81	83	83
Colour	-	RAL 7035 embossed effect			
Conformity	-	CE	CE	CE	CE

Accessories

Pack of 5 fabric air filters	C15000181
Pack of 1 metal air filter	C15000182
External stainless-steel framework	
Coating in non-standard colour	

EGO

Door- or wall-mount air conditioners

High reliability, reduced maintenance and a wide range of available power outputs makes the EGO range **texa industries'** answer to the most varied air conditioning requirements.



EGO

Door- or wall-mount air conditioners

WIDE RANGE OF POWER OUTPUTS

The available power outputs range from 300 to 14800 W, covering most electrical cabinet cooling requirements in an extremely compact size.

ELECTRONIC THERMOSTAT

All **texa industries** air conditioning systems are equipped with electronic thermostat as standard.

QUICK INSTALLATION

Installation is very quick by simply drilling the cabinet panel and fastening systems which are included in the air conditioner package. This features provisions for the electrical connections to be made quickly and safely using fast connectors inserted in the rear of the unit.

IDEAL COOLING FOR THE UNIT

The air inside the cabinet is taken in from the upper part of the cabinet, cooled inside the air conditioner and directed back into the cabinet with a high-speed flow directed towards the bottom. This ensures both optimum cooling of the entire cabinet and the prevention of hot points in the electronic components.

REDUCED MAINTENANCE

All units are equipped with heat exchange surfaces designed to prevent clogging by solid contaminants present in the ambient air. The condensing coils are protected by a hydrophilic treatment which prevents dirt and corrosion. They maintain high levels of efficiency even in demanding environmental conditions, drastically reducing maintenance requirements and thus allowing the air conditioner to operate without an external air filter.

IP55 CABINET INGRESS PROTECTION

Thanks to the special internal configuration, which separates the external and internal air flows in a sealed manner, and the new self-adhesive coupling gasket, EGO air conditioners (from the EGO S3 model to the EGO 40 model) allow the cabinet to retain an IP55 rating.

ANTI-CONDENSATION EVAPORATION SYSTEM

EGO air conditioners (starting with the EGO08 model) are equipped with an integrated condensate recovery system which allows installation costs to be further reduced.

ENVIRONMENTAL PROTECTION

Reduction of noise levels is a precise criterion aimed at when developing EGO air conditioners. They have been designed to minimise disturbance from noise and thus help provide quiet working environments. To help protect the environment, these air conditioners use R134a or R407C CFC-free refrigerant, which do not damage the ozone layer.

SUPPLY VOLTAGE

EGO air conditioners are available for the most common AC voltages: 230V single phase, 400-440V two phase (for concatenated voltage power supply when neutral is not present), 115V single phase, 400V three phase, all in 50-60 Hz dual frequency versions, and 400V and 460V three phase single frequency (50 or 60 Hz) versions. On request, versions for voltages not present in the catalogue can be produced for orders of sufficient quantities.

PAINT/COATING

The standard colour is RAL 7035 textured. The coating is epoxy powder coating. Non-standard colours and stainless-steel versions are available on request.



Two installation options:

A External - **B** Semi-recessed (Version "0" available on request - dimensional drawings on page 180-181)



Application tips

- When choosing an air conditioner, keep a margin of safety of at least 10% for the power output, taking the most demanding conditions of operation into account.
- Seal the cabinet well. Any cracks or other openings would significantly reduce the efficiency of the air conditioner and produce excessive amounts of condensate.
- The air conditioner may be installed on the door or the wall, but always in the highest possible position in order to ensure that air is taken in from the top part of the cabinet, where there is a high temperature area.
- The air conditioner is factory set to 35°C, the optimum temperature for most applications. Unless strictly necessary, avoiding lowering this temperature because it would reduce the efficiency of the air conditioner and cause excessive condensate production.
- Try to facilitate the air flow inside the electrical cabinet when designing the layout of the components. Avoid blocking the air inlet or outlet with components installed too close together. Any components with internal ventilation of their own must have their air flow arranged so as to not impede the air flow of the air conditioner.
- Disable the air conditioner if the cabinet doors are opened to prevent excessive condensate production. Install a limit switch on the door for this purpose.
- The air conditioner power supply line must be protected with a time delay fuse or circuit breaker of suitable size on the basis of the unit's technical data.

EGOS3

Door- or wall-mount air conditioners

COOLING CAPACITY

300 W



Features	UoM	EGOS3BT1B
Cooling capacity EN14511 - A35A35	W	300
Cooling capacity EN14511 - A35A50	W	150
Power supply	V ~ Hz	230 1~ 50-60
Width	mm	525
Height	mm	345
Depth	mm	136
Max current	A	1.5
Inrush current	A	4.2
T Fuse	A	4
Power draw EN14511 - A35A35	W	270
Power draw EN14511 -A35A50	W	310
Operating cycle	-	100%
Electrical connection	-	4-pin plug
R134a Refrigerant	kg	0.12
Max refrigeration circuit pressure	bar	25
External air fan capacity	m ³ /h	280
Cabinet air fan capacity	m ³ /h	280
Internal temperature range	°C	20-46
Temperature regulation	-	Electronic thermostat, factory set to 35°C
External temperature range	°C	20-55*
EN60529 ingress protection - cabinet side	-	IP55
EN60529 ingress protection - ambient side	-	IP34
Noise level	dB (A)	61
Weight	kg	14
Colour	-	RAL 7035 embossed effect
Conformity	-	CE

Accessories	
External stainless-steel framework	
Coating in non-standard colour	

* 50 °C at 60 Hz

Performance

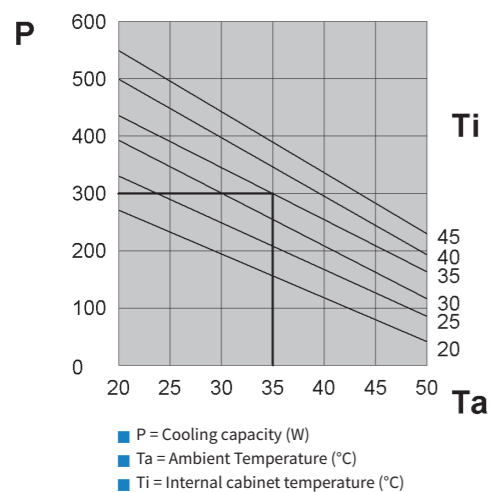

Dimensions

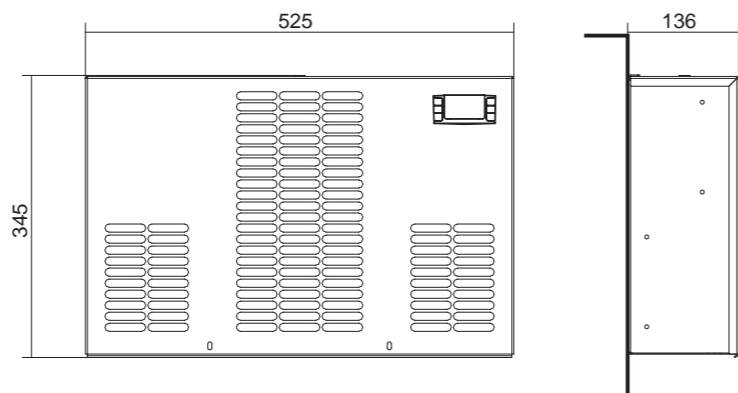

EGO04

Door- or wall-mount air conditioners

COOLING CAPACITY

380 W



Features	UoM	EGO04BT1B	EGO04BTVBX0000	EGO04CT1B
Cooling capacity EN14511 - A35A35	W	380	380	380
Cooling capacity EN14511 - A35A50	W	240	240	240
Power supply	V ~ Hz	230 1~ 50-60	230 1~ 50-60	115 1~ 50-60
Width	mm	285	285	285
Height	mm	460	460	460
Depth	mm	180	180	180+35**
Max current	A	1.6	1.7	3.2
Inrush current	A	6	6	11
T Fuse	A	4	4	6
Power draw EN14511 - A35A35	W	230	280	240
Power draw EN14511 -A35A50	W	260	330	270
Operating cycle	-	100%	100%	100%
Electrical connection	-	4-pin plug	4-pin plug	4-pin plug
R134a Refrigerant	kg	0.13	0.16	0.13
Max refrigeration circuit pressure	bar	26	28	26
External air fan capacity	m ³ /h	280	280	280
Cabinet air fan capacity	m ³ /h	280	280	280
Internal temperature range	°C	20-50	20-50	20-50
Temperature regulation	-	Electronic thermostat, factory set to 35°C		
External temperature range	°C	20-55*	20-55*	20-50
EN60529 ingress protection - cabinet side	-	IP55	IP55	IP55
EN60529 ingress protection - ambient side	-	IP34	IP34	IP34
Noise level	dB (A)	60	65	60
Weight	kg	17	17	18
Colour	-	RAL 7035 embossed effect		
Conformity	-	CE	CE	CE

Accessories	
Pack of 5 fabric air filters	AAEFP04
Pack of 1 metal air filter	AAEFM04
Version "0", semi-recessed installation	
External stainless-steel framework	
Coating in non-standard colour	

** for external autotransformer dimensions * 50 °C at 60 Hz

Performance

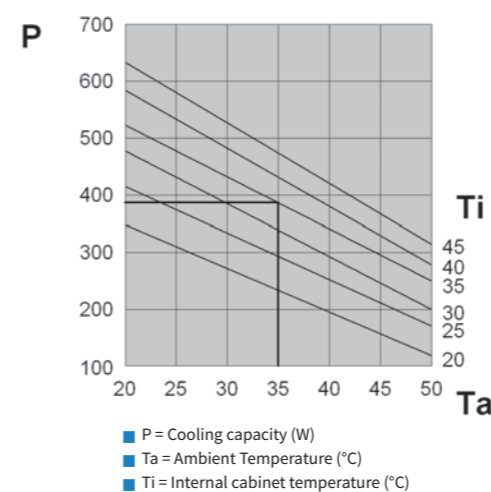

Dimensions

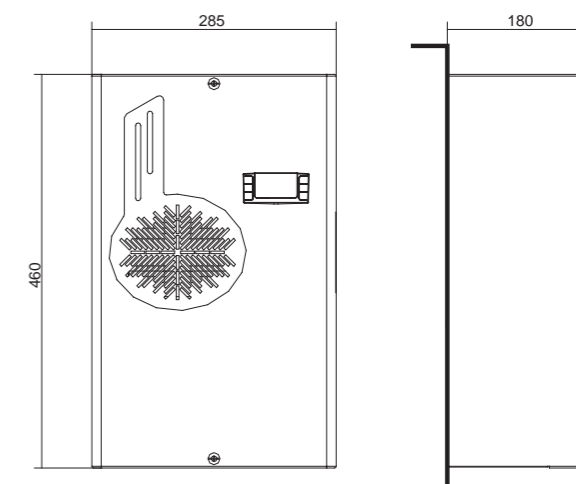

EGO06

Door- or wall-mount air conditioners

COOLING CAPACITY

640 W



Performance

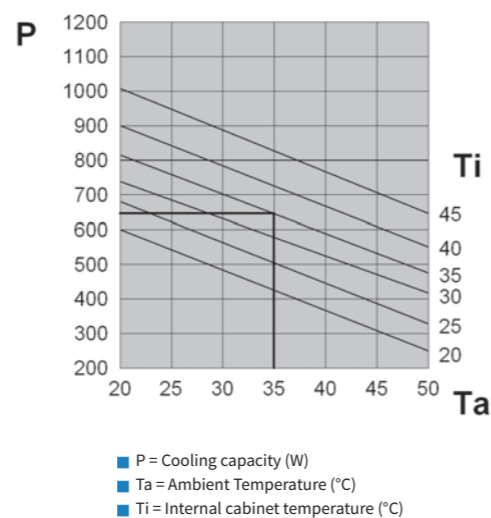

Dimensions

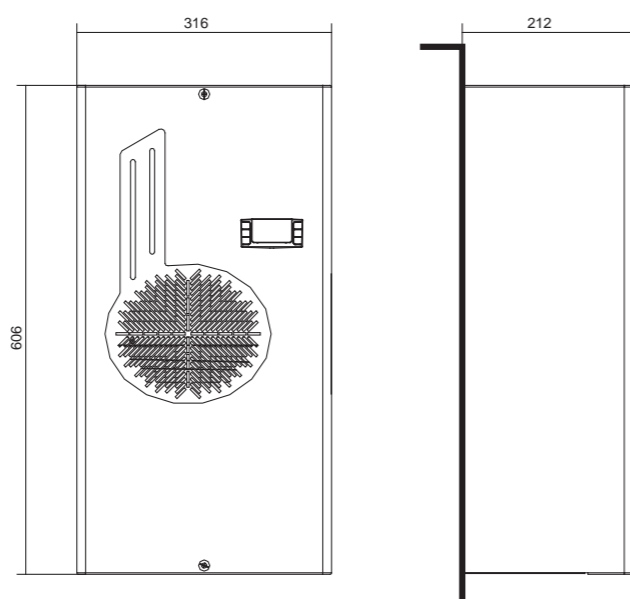

Features	UoM	EGO06BT1B	EGO06TVBX0000	EGO06CT1B	EGO06GT1B
Cooling capacity EN14511 - A35A35	W	640	640	640	640
Cooling capacity EN14511 - A35A50	W	470	470	470	470
Power supply	V ~ Hz	230 1~ 50-60	230 1~ 50-60	115 1~ 50-60	400/440 2~ 50-60
Width	mm	316	316	316	316
Height	mm	606	606	606	606
Depth	mm	212	212	212+42**	212+58**
Max current	A	2.1	2.6	4.4	1.2
Inrush current	A	8.1	8.1	16	5
T Fuse	A	6	6	8	2
Power draw EN14511 - A35A35	W	380	400	390	390
Power draw EN14511 -A35A50	W	420	470	430	430
Operating cycle	-	100%	100%	100%	100%
Electrical connection	-	4-pin plug	4-pin plug	4-pin plug	4-pin plug
R134a Refrigerant	kg	0.19	0.23	0.19	0.19
Max refrigeration circuit pressure	bar	25	28	25	25
External air fan capacity	m ³ /h	570	570	570	570
Cabinet air fan capacity	m ³ /h	330	330	330	330
Internal temperature range	°C	20-50	20-50	20-50	20-50
Temperature regulation	-	Electronic thermostat factory set to 35°C			
External temperature range	°C	20-55*	20-55*	20-50	20-50
EN60529 ingress protection - cabinet side	-	IP55	IP55	IP55	IP55
EN60529 ingress protection - ambient side	-	IP34	IP34	IP34	IP34
Noise level	dB (A)	65	65	65	65
Weight	kg	21	21	22	22
Colour	-	RAL 7035 embossed effect			
Conformity	-	CE	CE	CE	CE

Accessories	
Pack of 5 fabric air filters	AAEFP06
Pack of 1 metal air filter	AAEFM06
Version "0", semi-recessed installation	
External stainless-steel framework	
Coating in non-standard colour	

* 50 °C at 60 Hz
** for external autotransformer dimensions



EGO08

Door- or wall-mount air conditioners

COOLING CAPACITY

820 W

Performance

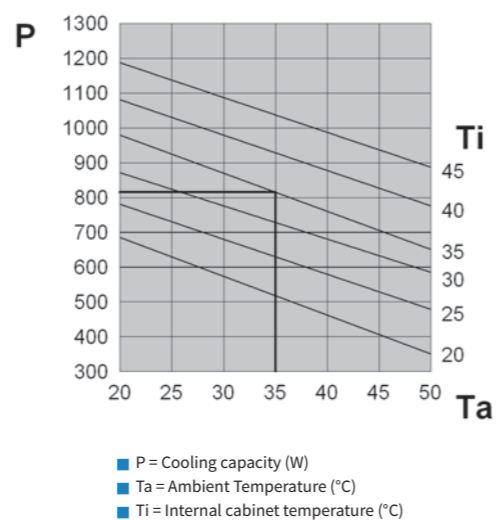

Dimensions

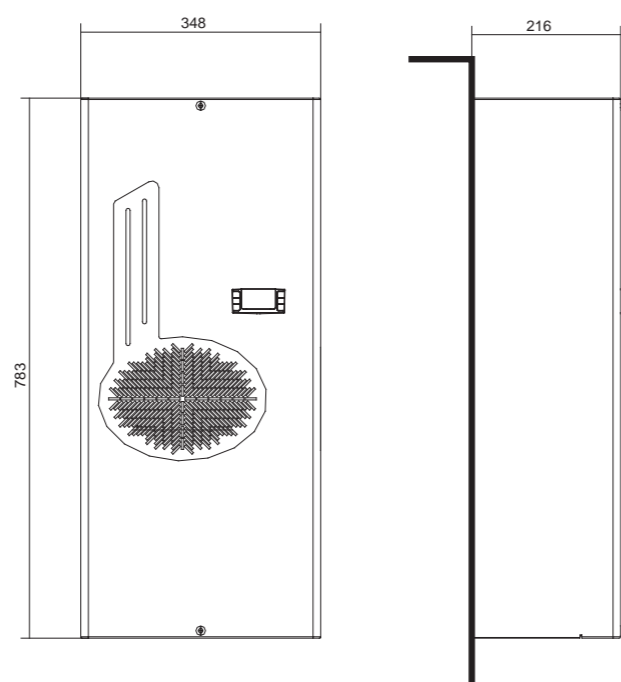

Features	UoM	EGO08BT1B	EGO08BTVBX0000	EGO08CT1B	EGO08GT1B
Cooling capacity EN14511 - A35A35	W	820	820	820	820
Cooling capacity EN14511 - A35A50	W	680	680	680	680
Power supply	V - Hz	230 1~ 50-60	230 1~ 50-60	115 1~ 50-60	400/440 2~ 50-60
Width	mm	348	348	348	348
Height	mm	783	783	783	783
Depth	mm	216	216	216+42**	216+58**
Max current	A	2.6	3.1	5.3	1.7
Inrush current	A	10.8	10.8	21.5	6.1
T Fuse	A	6	6	10	6
Power draw EN14511 - A35A35	W	410	440	420	420
Power draw EN14511 -A35A50	W	490	490	500	500
Operating cycle	-	100%	100%	100%	100%
Electrical connection	-	4-pin plug	4-pin plug	4-pin plug	4-pin plug
R134a Refrigerant	kg	0.21	0.21	0.21	0.21
Max refrigeration circuit pressure	bar	25	28	25	25
External air fan capacity	m ³ /h	570	570	570	570
Cabinet air fan capacity	m ³ /h	330	330	330	330
Internal temperature range	°C	20-50	20-50	20-50	20-50
Temperature regulation	-	Electronic thermostat factory set to 35°C			
External temperature range	°C	20-55*	20-55*	20-50	20-50
EN60529 ingress protection - cabinet side	-	IP55	IP55	IP55	IP55
EN60529 ingress protection - ambient side	-	IP34	IP34	IP34	IP34
Noise level	dB (A)	65	65	65	65
Weight	kg	27	27	28	28
Colour	-	RAL 7035 embossed effect			
Conformity	-	CE	CE, UL US	CE	CE

Accessories	
Pack of 5 fabric air filters	AAEFP10
Pack of 1 metal air filter	AAEFM10
Version "0", semi-recessed installation	
External stainless-steel framework	
Coating in non-standard colour	

* 50 °C at 60 Hz

** for external autotransformer dimensions



EGO10

Door- or wall-mount air conditioners

COOLING CAPACITY

1000 W

Performance

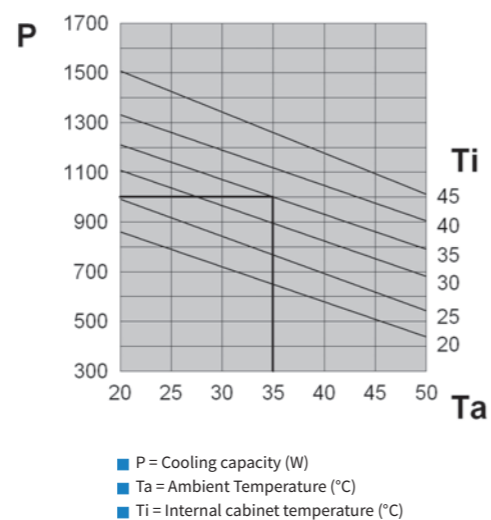

Dimensions

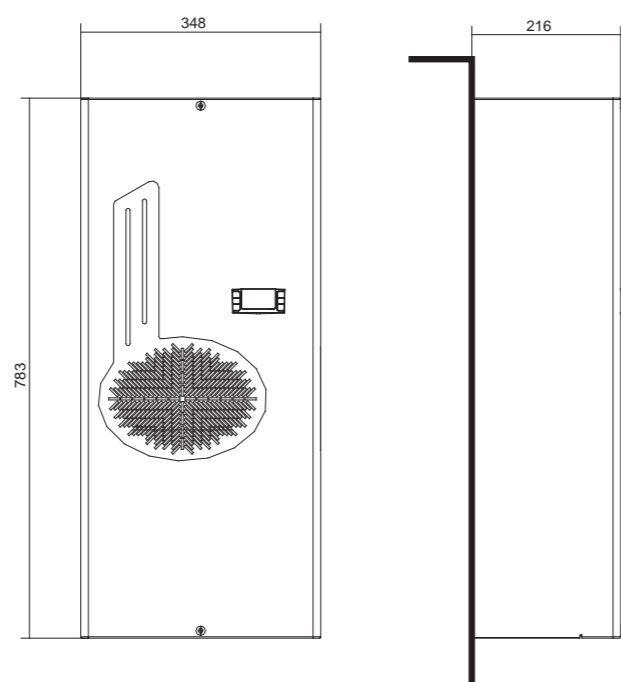

Features	UoM	EGO10BT1B	EGO10TVBX0000	EGO10CT1B	EGO10GT1B	EGO10KTVBX0000
Cooling capacity EN14511 - A35A35	W	1000	1000	1000	1000	1000
Cooling capacity EN14511 - A35A50	W	790	790	790	790	790
Power supply	V ~ Hz	230 1~ 50-60	230 1~ 50-60	115 1~ 50-60	400/440 2~ 50-60	400/460 2~ 50-60
Width	mm	348	348	348	348	348
Height	mm	783	783	783	783	783
Depth	mm	216	216	216+42**	216+58**	216+58**
Max current	A	3	3.1	6.7	2	2
Inrush current	A	10.5	10.5	23	8	8
T Fuse	A	6	6	10	4	4
Power draw EN14511 - A35A35	W	470	590	490	490	620
Power draw EN14511 - A35A50	W	560	670	580	580	710
Operating cycle	-	100%	100%	100%	100%	100%
Electrical connection	-	4-pin plug	4-pin plug	4-pin plug	4-pin plug	4-pin plug
R134a Refrigerant	kg	0.2	0.24	0.2	0.2	0.24
Max refrigeration circuit pressure	bar	25	28	25	25	28
External air fan capacity	m ³ /h	570	570	570	570	570
Cabinet air fan capacity	m ³ /h	330	330	330	330	330
Internal temperature range	°C	20-50	20-50	20-50	20-50	20-50
Temperature regulation	-	Electronic thermostat factory set to 35°C				
External temperature range	°C	20-55*	20-50	20-50	20-50	20-50
EN60529 ingress protection - cabinet side	-	IP55	IP55	IP55	IP55	IP55
EN60529 ingress protection - ambient side	-	IP34	IP34	IP34	IP34	IP34
Noise level	dB (A)	65	65	65	65	65
Weight	kg	28	28	29	29	29
Colour	-	RAL 7035 embossed effect				
Conformity	-	CE	CE	CE	CE	CE

Accessories	
Pack of 5 fabric air filters	AAEFP10
Pack of 1 metal air filter	AAEFM10
Version "0", semi-recessed installation	
External stainless-steel framework	
Coating in non-standard colour	

* 50 °C at 60 Hz
** for external autotransformer dimensions



EGO12

Door- or wall-mount air conditioners

COOLING CAPACITY

1250 W

Performance

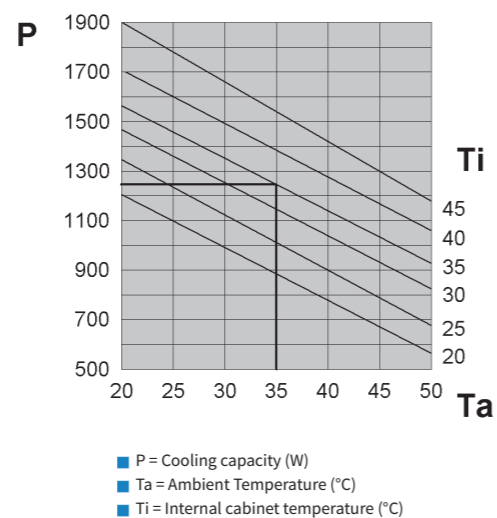

Dimensions

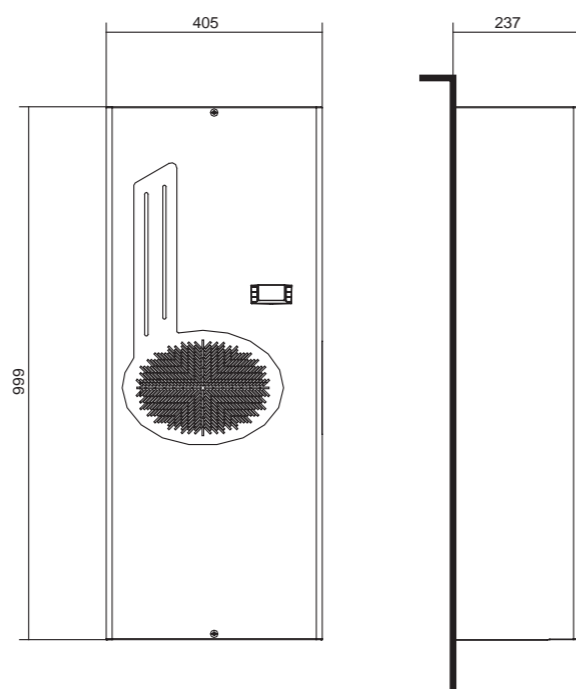

Features	UoM	EGO12BT1B	EGO12BTVBX0000	EGO12CT1B	EGO12GT1B
Cooling capacity EN14511 - A35A35	W	1250	1250	1250	1250
Cooling capacity EN14511 - A35A50	W	910	910	910	910
Power supply	V - Hz	230 1~ 50-60	230 1~ 50-60	115 1~ 50-60	400/440 2~ 50-60
Width	mm	405	405	405	405
Height	mm	999	999	999	999
Depth	mm	237	237	237	237
Max current	A	3.8	5	7.6	2.2
Inrush current	A	11	11	24	8.5
T Fuse	A	6	8	10	4
Power draw EN14511 - A35A35	W	680	710	690	690
Power draw EN14511 -A35A50	W	790	820	800	800
Operating cycle	-	100%	100%	100%	100%
Electrical connection	-	4-pin plug	4-pin plug	4-pin plug	4-pin plug
R134a Refrigerant	kg	0.26	0.29	0.26	0.26
Max refrigeration circuit pressure	bar	25	28	25	25
External air fan capacity	m ³ /h	860	860	860	860
Cabinet air fan capacity	m ³ /h	570	570	570	570
Internal temperature range	°C	20-50	20-50	20-50	20-50
Temperature regulation	-	Electronic thermostat factory set to 35°C			
External temperature range	°C	20-55*	20-50	20-50	20-50
EN60529 ingress protection - cabinet side	-	IP55	IP55	IP55	IP55
EN60529 ingress protection - ambient side	-	IP34	IP34	IP34	IP34
Noise level	dB (A)	65	65	65	65
Weight	kg	38	38	40	40
Colour	-	RAL 7035 embossed effect			
Conformity		CE	CE cULus	CE	CE

Accessories	
Pack of 5 fabric air filters	C15000163
Pack of 1 metal air filter	C15000164
Version "0", semi-recessed installation	
External stainless-steel framework	
Coating in non-standard colour	

* 50 °C at 60 Hz



EGO16

Door- or wall-mount air conditioners

COOLING CAPACITY

1600 W



Performance

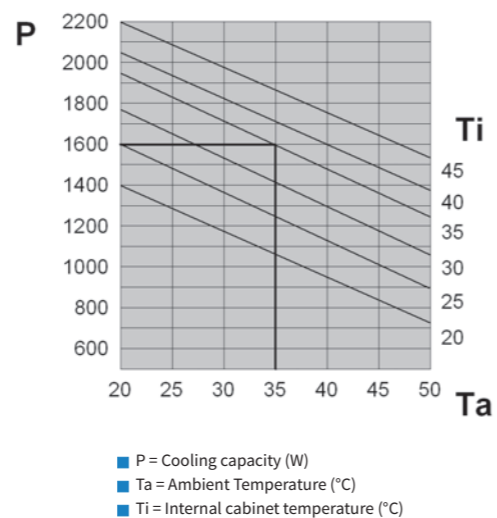

Dimensions

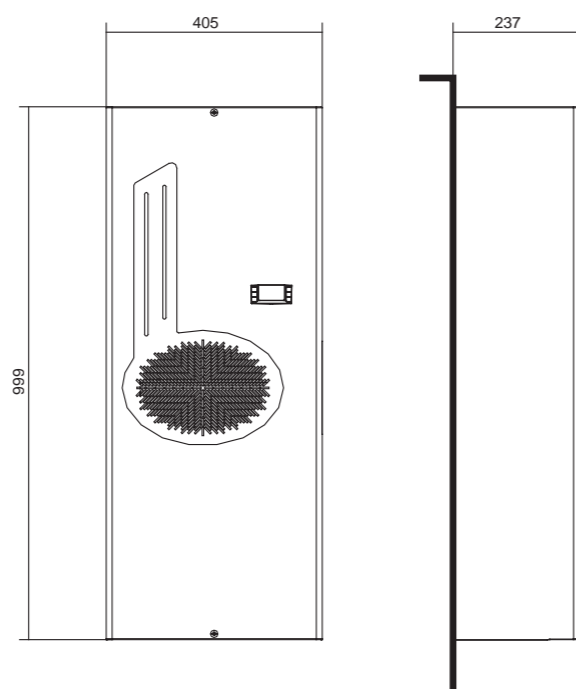

Features	UoM	EGO16BT1B	EGO16BTVBX0000	EGO16CT1B	EGO16GT1B	EGO16KTVBX0000
Cooling capacity EN14511 - A35A35	W	1600	1600	1600	1600	1600
Cooling capacity EN14511 - A35A50	W	1230	1230	1230	1230	1230
Power supply	V ~ Hz	230 1~ 50-60	230 1~ 50-60	115 1~ 50-60	400/440 2~ 50-60	400/460 2~ 50-60
Width	mm	405	405	405	405	405
Height	mm	999	999	999	999	999
Depth	mm	237	237	237	237	237
Max current	A	5.3	6	12.9	2.9	3
Inrush current	A	18	18	39	11	11
T Fuse	A	10	10	20	6	5
Power draw EN14511 - A35A35	W	820	850	840	840	960
Power draw EN14511 - A35A50	W	940	970	960	960	1170
Operating cycle	-	100%	100%	100%	100%	100%
Electrical connection	-	4-pin plug	4-pin plug	4-pin plug	4-pin plug	4-pin plug
R134a Refrigerant	kg	0.33	0.43	0.33	0.33	0.43
Max refrigeration circuit pressure	bar	25	28	25	25	28
External air fan capacity	m ³ /h	1050	1050	1050	1050	1050
Cabinet air fan capacity	m ³ /h	570	570	570	570	570
Internal temperature range	°C	20-50	20-50	20-50	20-50	20-50
Temperature regulation	-	Electronic thermostat factory set to 35°C				
External temperature range	°C	20-55*	20-50	20-50	20-50	20-50
EN60529 ingress protection - cabinet side	-	IP55	IP55	IP55	IP55	IP55
EN60529 ingress protection - ambient side	-	IP34	IP34	IP34	IP34	IP34
Noise level	dB (A)	65	65	65	65	65
Weight	kg	40	40	42	42	42
Colour	-	RAL 7035 embossed effect				
Conformity	-	CE	CE	CE	CE	CE

* 50 °C at 60 Hz

Accessories	
Pack of 5 fabric air filters	C15000163
Pack of 1 metal air filter	C15000164
Version "0", semi-recessed installation	
External stainless-steel framework	
Coating in non-standard colour	



EGO20

Door- or wall-mount air conditioners

COOLING CAPACITY

2000 W



Performance

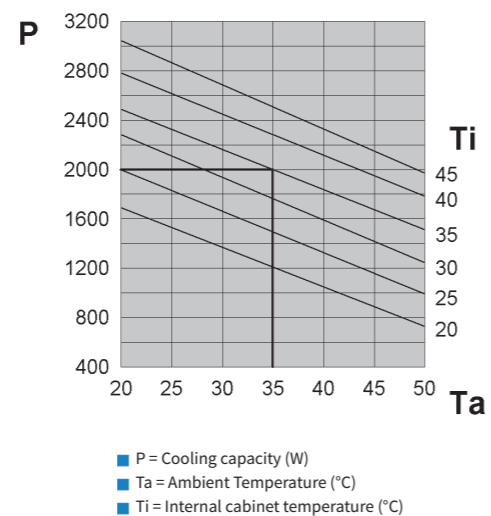

Dimensions

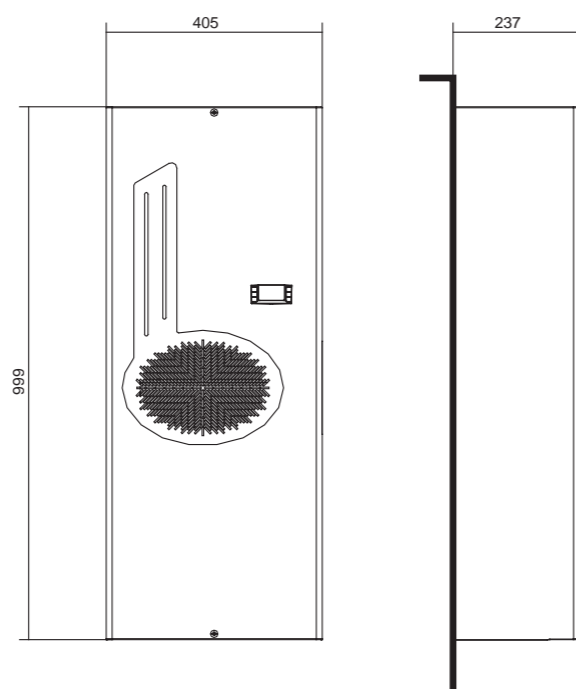

Features	UoM	EGO20BT1B	EGO20BTVBX0000	EGO20CT1B	EGO20LT1B	EGO20NTVBX0000
Cooling capacity EN14511 - A35A35	W	2000	2000	2000	2000	2000
Cooling capacity EN14511 - A35A50	W	1510	1510	1510	1510	1510
Power supply	V ~ Hz	230 1~ 50-60	230 1~ 50-60	115 1~ 50-60	400 3~ 50-60	460 3~ 60
Width	mm	405	405	405	405	405
Height	mm	999	999	999	999	999
Depth	mm	237	237	237	237	237
Max current	A	6.5	7	13.3	2.5	2.7
Inrush current	A	24	24	48	10	14
T Fuse	A	10	10	20	6	5
Power draw EN14511 - A35A35	W	1080	1100	1070	970	1220
Power draw EN14511 -A35A50	W	1290	1300	1210	1150	1440
Operating cycle	-	100%	100%	100%	100%	100%
Electrical connection	-	4-pin plug	4-pin plug	4-pin plug	4-pin plug	4-pin plug
R134a Refrigerant	kg	0.43	0.54	0.43	0.45	0.61
Max refrigeration circuit pressure	bar	25	28	25	25	28
External air fan capacity	m ³ /h	1050	1050	1050	1050	1050
Cabinet air fan capacity	m ³ /h	860	860	860	860	860
Internal temperature range	°C	20-50	20-50	20-50	20-50	20-50
Temperature regulation	-	Electronic thermostat factory set to 35°C				
External temperature range	°C	20-55*	20-50	20-50	20-50	20-50
EN60529 ingress protection - cabinet side	-	IP55	IP55	IP55	IP55	IP55
EN60529 ingress protection - ambient side	-	IP34	IP34	IP34	IP34	IP34
Noise level	dB (A)	65	65	65	65	65
Weight	kg	52	52	54	54	54
Colour	-	RAL 7035 embossed effect				
Conformity	-	CE	CE	CE	CE	CE

Accessories	
Pack of 5 fabric air filters	C15000163
Pack of 1 metal air filter	C15000164
Version "0", semi-recessed installation	
External stainless-steel framework	
Coating in non-standard colour	

* 50 °C at 60 Hz



EGO30

Door- or wall-mount air conditioners

COOLING CAPACITY

2900 W



Features	UoM	EGO30BT1B	EGO30LT1B	EGO30NTVBX0000
Cooling capacity EN14511 - A35A35	W	2900	2900	2900
Cooling capacity EN14511 - A35A50	W	2250	2250	2250
Power supply	V ~ Hz	230 1~ 50-60	400 3~ 50-60	460 3~ 60
Width	mm	500	500	500
Height	mm	1270	1270	1270
Depth	mm	336	336	336
Max current	A	8.2	2.6	3.7
Inrush current	A	37.4	14	15
T Fuse	A	16	6	6
Power draw EN14511 - A35A35	W	1340	1220	1810
Power draw EN14511 -A35A50	W	1560	1440	2020
Operating cycle	-	100%	100%	100%
Electrical connection	-	4-pin plug	4-pin plug	4-pin plug
R134a Refrigerant	kg	0.57	0.62	0.84
Max refrigeration circuit pressure	bar	25	25	28
External air fan capacity	m ³ /h	1450	1450	1450
Cabinet air fan capacity	m ³ /h	1450	1450	1450
Internal temperature range	°C	20-50	20-50	20-50
Temperature regulation	-	Electronic thermostat, factory set to 35°C		
External temperature range	°C	20-50	20-50	20-50
EN60529 ingress protection - cabinet side	-	IP55	IP55	IP55
EN60529 ingress protection - ambient side	-	IP34	IP34	IP34
Noise level	dB (A)	70	70	70
Weight	kg	80	84	84
Colour	-	RAL 7035 embossed effect		
Conformity	-	CE	CE	CE c RA 05

Accessories	
Pack of 5 fabric air filters	C15000183
Pack of 1 metal air filter	C15000185
Version "0", semi-recessed installation	
External stainless-steel framework	
Coating in non-standard colour	

Performance

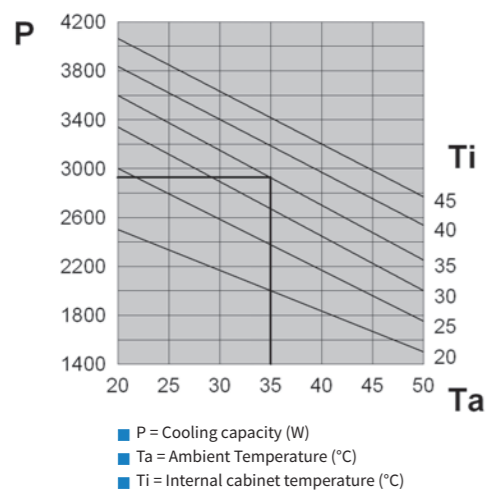

Dimensions

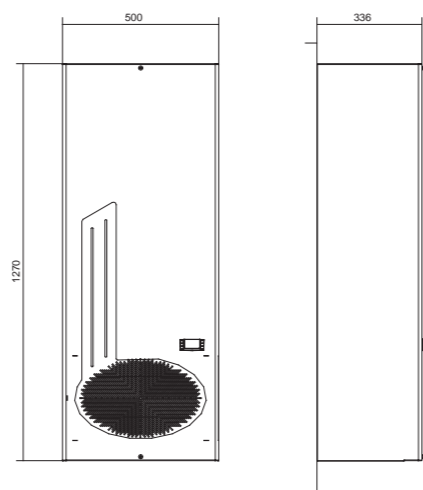

EGO40

Door- or wall-mount air conditioners

COOLING CAPACITY

3850 W



Features	UoM	EGO40BT1B	EGO40LT1B	EGO40NTVBX0000
Cooling capacity EN14511 - A35A35	W	3850	3850	3850
Cooling capacity EN14511 - A35A50	W	2870	2870	2870
Power supply	V ~ Hz	230 1~ 50-60	400 3~ 50-60	460 3~ 60
Width	mm	500	500	500
Height	mm	1270	1270	1270
Depth	mm	336	336	336
Max current	A	9.5	3.6	4.2
Inrush current	A	35.2	18	18
T Fuse	A	16	8	8
Power draw EN14511 - A35A35	W	1710	1780	2040
Power draw EN14511 -A35A50	W	1990	2050	2350
Operating cycle	-	100%	100%	100%
Electrical connection	-	4-pin plug	4-pin plug	4-pin plug
R134a Refrigerant	kg	0.69	0.69	1.14
Max refrigeration circuit pressure	bar	25	25	28
External air fan capacity	m ³ /h	1450	1450	1450
Cabinet air fan capacity	m ³ /h	1450	1450	1450
Internal temperature range	°C	20-50	20-50	20-50
Temperature regulation	-	Electronic thermostat, factory set to 35°C		
External temperature range	°C	20-50	20-50	20-50
EN60529 ingress protection - cabinet side	-	IP55	IP55	IP55
EN60529 ingress protection - ambient side	-	IP34	IP34	IP34
Noise level	dB (A)	70	70	70
Weight	kg	82	85	85
Colour	-	RAL 7035 embossed effect		
Conformity	-	CE	CE	CE c RA 05

Accessories	
Pack of 5 fabric air filters	C15000183
Pack of 1 metal air filter	C15000185
Version "0", semi-recessed installation	
External stainless-steel framework	
Coating in non-standard colour	

Performance

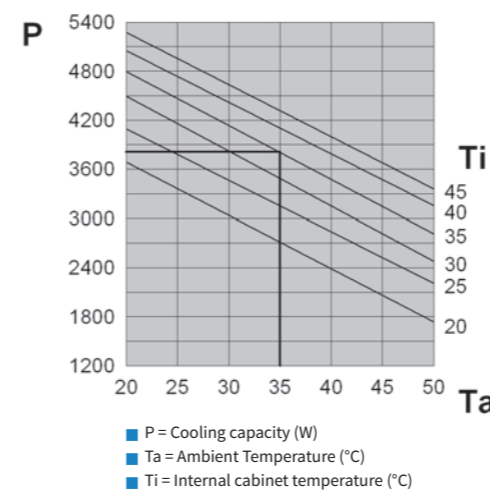

Dimensions

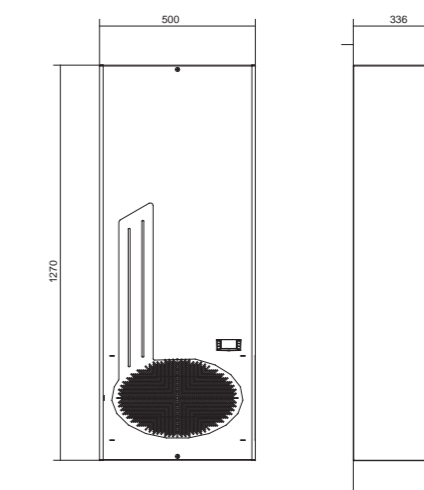

EGO60

Door- or wall-mount air conditioners

COOLING CAPACITY

5800 - 6050 W



Features	UoM	EGO60MTEB	EGO60NTEB
Cooling capacity EN14511 - A35A35	W	5800	6050
Cooling capacity EN14511 - A35A50	W	4350	4530
Power supply	V ~ Hz	400 3~ 50	460 3~ 60
Width	mm	600	600
Height	mm	2000	2000
Depth	mm	387	387
Max current	A	5.9	6.8
Inrush current	A	21.7	23.5
T Fuse	A	8	8
Power draw EN14511 - A35A35	W	2340	2920
Power draw EN14511 -A35A50	W	3880	4520
Operating cycle	-	100%	100%
Electrical connection	-	Cable L = 3 m	Cable L = 3 m
R407C Refrigerant	kg	1.8	1.8
Max refrigeration circuit pressure	bar	27	27
External air fan capacity	m ³ /h	2900	2900
Cabinet air fan capacity	m ³ /h	1450	1450
Internal temperature range	°C	20-46	20-46
Temperature regulation	-	Electronic thermostat, factory set to 35°C	
External temperature range	°C	20-50	20-50
EN60529 ingress protection - cabinet side	-	IP54	IP54
EN60529 ingress protection - ambient side	-	IP34	IP34
Noise level	dB (A)	72	72
Weight	kg	150	150
Colour	-	RAL 7035 embossed effect	
Conformity	-	CE	CE

Accessories	
Pack of 5 fabric air filters	C15000175
Pack of 1 metal air filter	C15000176
External stainless-steel framework	
Coating in non-standard colour	

EGO80

Door- or wall-mount air conditioners

COOLING CAPACITY

7600 - 7950 W



Features	UoM	EGO80MTEB	EGO80NTEB
Cooling capacity EN14511 - A35A35	W	7600	7950
Cooling capacity EN14511 - A35A50	W	5700	5930
Power supply	V ~ Hz	400 3~ 50	460 3~ 60
Width	mm	800	800
Height	mm	2000	2000
Depth	mm	387	387
Max current	A	8.1	9.3
Inrush current	A	30.7	32.5
T Fuse	A	16	16
Power draw EN14511 - A35A35	W	3300	4035
Power draw EN14511 -A35A50	W	4910	5845
Operating cycle	-	100%	100%
Electrical connection	-	Cable L = 3 m	Cable L = 3 m
R134a Refrigerant	kg	2.8	2.8
Max refrigeration circuit pressure	bar	27	27
External air fan capacity	m ³ /h	2900	2900
Cabinet air fan capacity	m ³ /h	2900	2900
Internal temperature range	°C	20-46	20-46
Temperature regulation	-	Electronic thermostat, factory set to 35°C	
External temperature range	°C	20-50	20-50
EN60529 ingress protection - cabinet side	-	IP54	IP54
EN60529 ingress protection - ambient side	-	IP34	IP34
Noise level	dB (A)	75	75
Weight	kg	160	160
Colour	-	RAL 7035 embossed effect	
Conformity	-	CE	CE

Accessories	
Pack of 5 fabric air filters	C15000188
Pack of 1 metal air filter	C15000189
External stainless-steel framework	
Coating in non-standard colour	

Performance (EGO60MTEB)

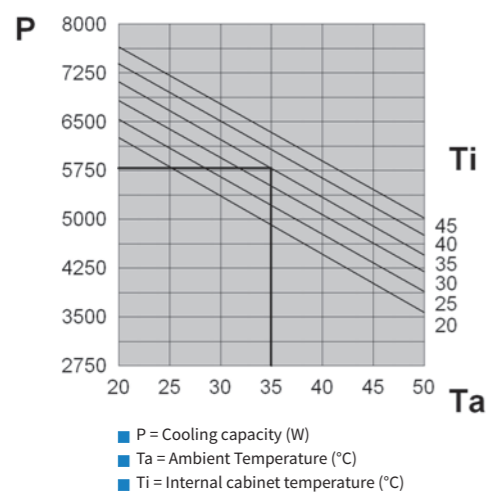

Dimensions

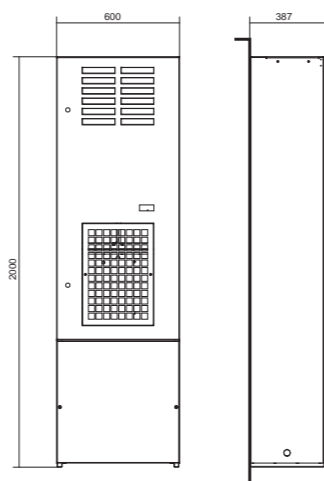

Performance (EGO80MTEB)

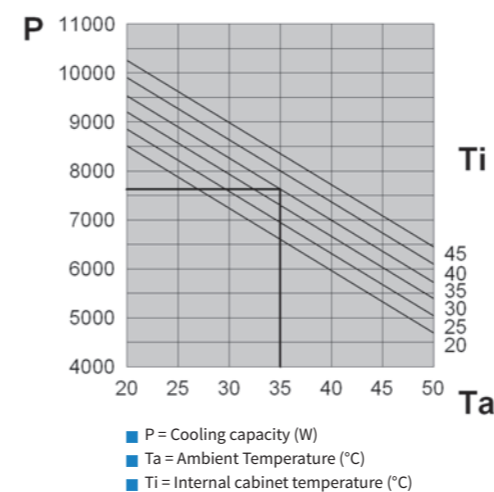

Dimensions

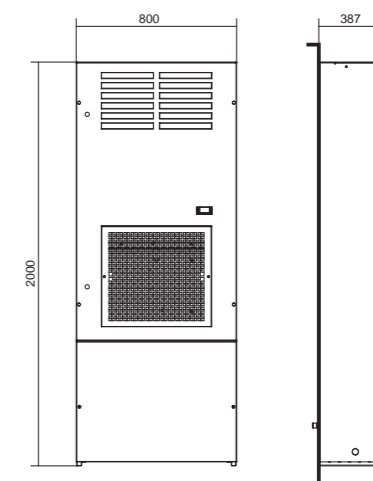

EGOA0

Door- or wall-mount air conditioners

COOLING CAPACITY

9400 - 9850 W



Features	UoM	EGOA0MTEB	EGOA0NTEB
Cooling capacity EN14511 - A35A35	W	9400	9850
Cooling capacity EN14511 - A35A50	W	7000	7350
Power supply	V ~ Hz	400 3~ 50	460 3~ 60
Width	mm	800	800
Height	mm	2000	2000
Depth	mm	387	387
Max current	A	9.1	10.3
Inrush current	A	30.7	32.5
T Fuse	A	18	18
Power draw EN14511 - A35A35	W	3650	4380
Power draw EN14511 - A35A50	W	5400	6340
Operating cycle	-	100%	100%
Electrical connection	-	Cable L = 3 m	Cable L = 3 m
R134a Refrigerant	kg	2.3	2.3
Max refrigeration circuit pressure	bar	27	27
External air fan capacity	m ³ /h	2900	2900
Cabinet air fan capacity	m ³ /h	2900	2900
Internal temperature range	°C	20-46	20-46
Temperature regulation	-	Electronic thermostat, factory set to 35°C	
External temperature range	°C	20-50	20-50
EN60529 ingress protection - cabinet side	-	IP54	IP54
EN60529 ingress protection - ambient side	-	IP34	IP34
Noise level	dB (A)	77	77
Weight	kg	180	180
Colour	-	RAL 7035 embossed effect	
Conformity	-	CE	CE

Accessories	
Pack of 5 fabric air filters	C15000188
Pack of 1 metal air filter	C15000189
External stainless-steel framework	
Coating in non-standard colour	

Performance (EGOA0MTEB)

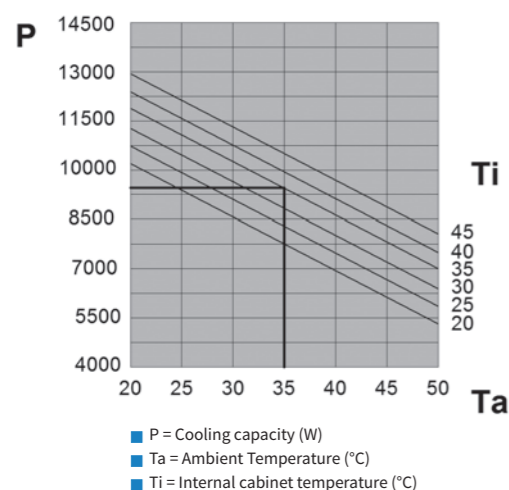

Dimensions

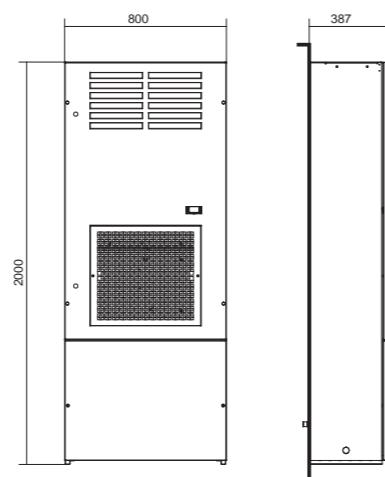

EGOA5

Door- or wall-mount air conditioners

COOLING CAPACITY

14800 - 15150 W



Features	UoM	EGOA5MTEB	EGOA5NTEB
Cooling capacity EN14511 - A35A35	W	14800	15150
Cooling capacity EN14511 - A35A50	W	11300	11600
Power supply	V ~ Hz	400 3~ 50	460 3~ 60
Width	mm	800	800
Height	mm	2000	2000
Depth	mm	550	550
Max current	A	11	11.8
Inrush current	A	49	51
T Fuse	A	20	20
Power draw EN14511 - A35A35	W	5750	6580
Power draw EN14511 - A35A50	W	6900	7760
Operating cycle	-	100%	100%
Electrical connection	-	Cable L = 3 m	Cable L = 3 m
R410A Refrigerant	kg	3.5	3.5
Max refrigeration circuit pressure	bar	39	39
External air fan capacity	m ³ /h	5800	5800
Cabinet air fan capacity	m ³ /h	4300	4300
Internal temperature range	°C	20-46	20-46
Temperature regulation	-	Electronic thermostat, factory set to 35°C	
External temperature range	°C	20-50	20-50
EN60529 ingress protection - cabinet side	-	IP54	IP54
EN60529 ingress protection - ambient side	-	IP34	IP34
Noise level	dB (A)	67	67
Weight	kg	240	240
Colour	-	RAL 7035 embossed effect	
Conformity	-	CE	CE

Accessories	
Pack of 5 fabric air filters	C15002900
Pack of 1 metal air filter	C15002497
External stainless-steel framework	
Coating in non-standard colour	

Performance (EGOA5MTEB)

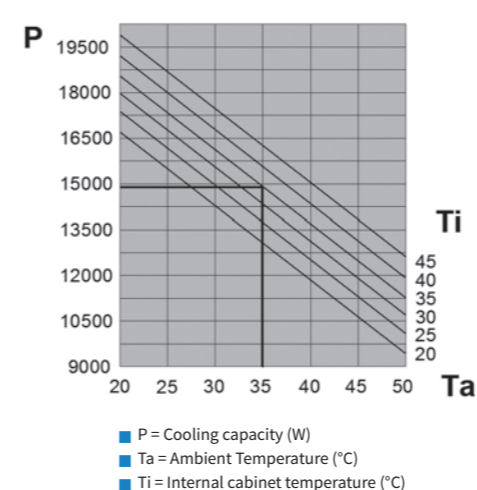

Dimensions

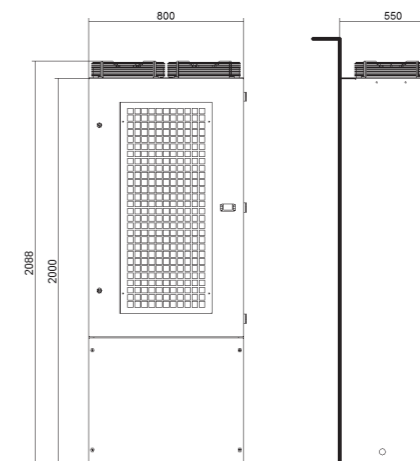

DEK

Roof-mount air conditioners

Compact size and robust design, combined with the best condensate management on the market, make the DEK series the ideal solution for roof installation.



DEK

Roof-mount air conditioners

WIDE RANGE OF POWER OUTPUTS

The available power outputs range from 410 to 3850 W, covering most electrical cabinet cooling requirements in an extremely compact size.

PROTECTION FROM CONDENSATE

Great attention has been paid to protecting the cabinet from condensate. Inside the air conditioner is a stainless-steel tray in which the condensate is collected, before being drained off through a service hose and second safety hose.

ELECTRONIC THERMOSTAT

All **texa industries** air conditioning systems are equipped with electronic thermostat as standard.

QUICK INSTALLATION

Installation is very quick by simply drilling the cabinet panel and fastening systems which are included in the air conditioner package. This features provisions for the electrical connections to be made quickly and safely using fast connectors inserted in the base of the unit.

REDUCED MAINTENANCE

All units are equipped with heat exchange surfaces designed to prevent clogging by solid contaminants present in the ambient air. They maintain high levels of efficiency even in demanding environmental conditions, drastically reducing maintenance requirements and thus allowing the air conditioner to operate without an external air filter.

OPTIMISED PROTECTION OF THE CABINET

Thanks to the special internal configuration, which separates the external and internal air flows in a sealed manner, and the self-adhesive coupling gasket, DEK air conditioners allow the cabinet to retain an IP54 rating.

ENVIRONMENTAL PROTECTION

Reduction of noise levels is a precise criterion aimed for when developing DEK air conditioners. They have been designed to minimise disturbance from noise and thus help provide quiet working environments. To help protect the environment, all our air conditioners use R134a CFC-free refrigerant, which does not damage the ozone layer.

SUPPLY VOLTAGE

DEK air conditioners are available for the most common AC voltages: 230V single phase, 400-440V two phase (for concatenated voltage power supply when neutral is not present), 115V single phase, 400V three phase, all in 50-60 Hz dual frequency. On request, versions for voltages not present in the catalogue can be produced for orders of sufficient quantities.

PAINT/COATING

The standard colour is RAL 7035 textured. The coating is epoxy powder coating. Non-standard colours and stainless-steel versions are available on request.

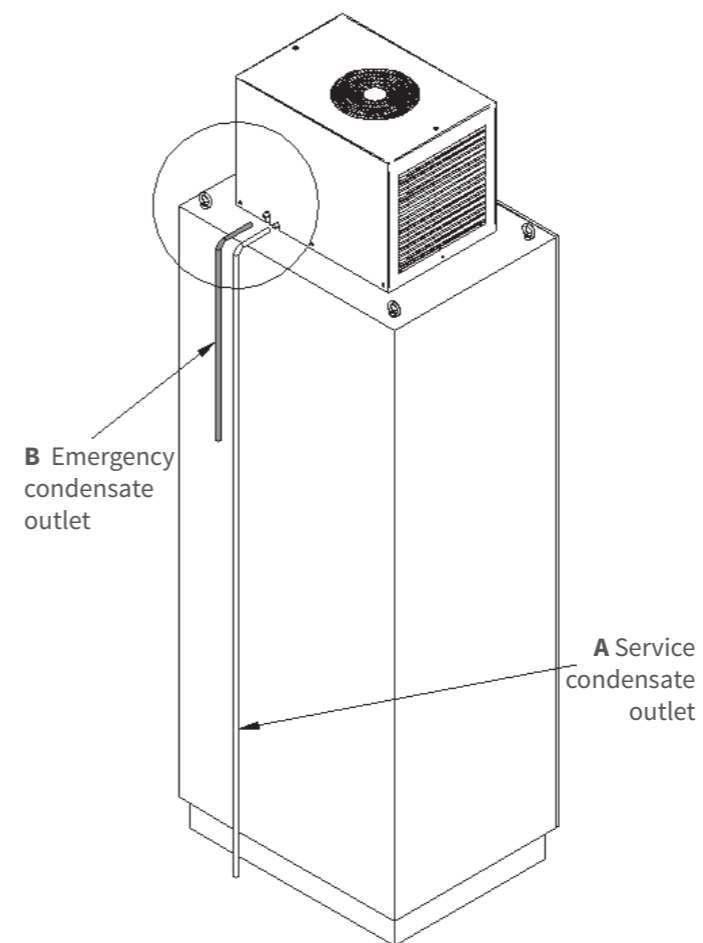

For maximum protection of the electrical components, DEK units are equipped with dual condensate outlets in the electrical cabinet.

The service outlet **A** allows condensate to drain off under normal operating conditions. In the event that the service hose or the internal path for the condensate is blocked, the condensate will drain out through the emergency outlet **B**. The service hose is transparent and runs along the base of the cabinet. The emergency hose is coloured and terminates at a short distance from the edge of the cabinet, in such a way as to remain visible.



Application tips

- When choosing an air conditioner, keep a margin of safety of at least 10% for the power output, taking the most demanding conditions of operation into account.
- Seal the cabinet well. Any cracks or other openings would significantly reduce the efficiency of the air conditioner and produce excessive amounts of condensate.
- Regularly inspect the condensate collection tray in order to remove any impurities.
- The air conditioner is factory set to 35°C, the optimum temperature for most applications. Unless strictly necessary, avoiding lowering this temperature because it would reduce the efficiency of the air conditioner and cause excessive condensate production.
- Try to facilitate the air flow inside the electrical cabinet when designing the layout of the components. Avoid blocking the air inlet or outlet with components installed too close together. Any components with internal ventilation of their own must have their air flow arranged so as to not impede the air flow of the air conditioner.
- Disable the air conditioner if the cabinet doors are opened to prevent excessive condensate production. Install a limit switch on the door for this purpose.
- The air conditioner power supply line must be protected with a time delay fuse or circuit breaker of suitable size on the basis of the unit's technical data.

DEK04

Roof-mount air conditioners

COOLING CAPACITY

410 W

Performance

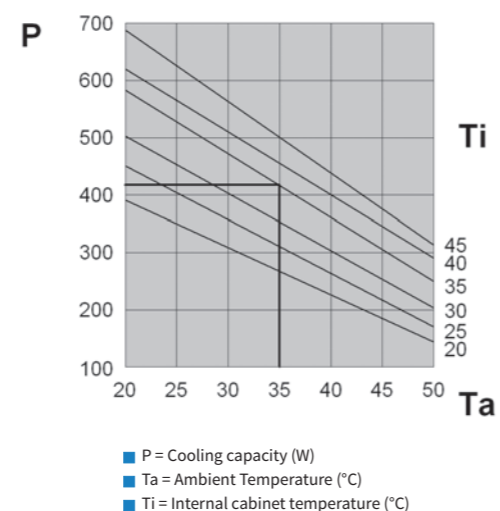

Dimensions

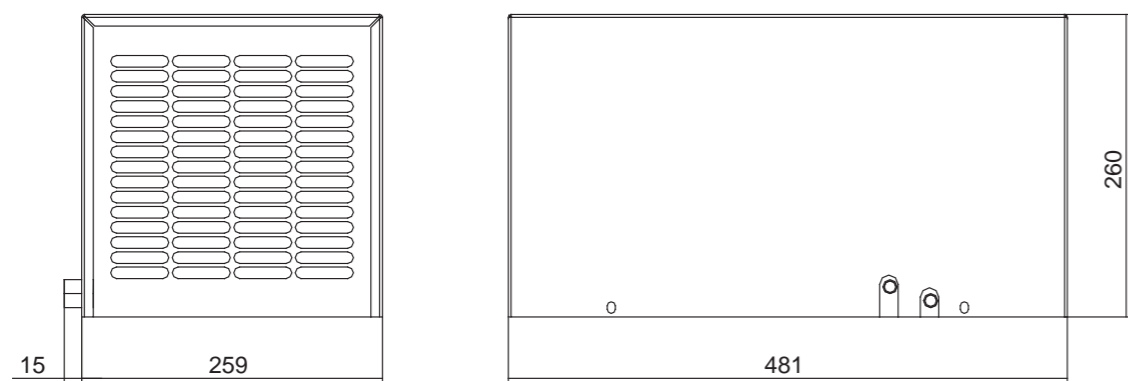

Features	UoM	DEK04BT0B	DEK04BTUB	DEK04CT0B
Cooling capacity EN14511 - A35A35	W	410	410	410
Cooling capacity EN14511 - A35A50	W	240	240	240
Power supply	V - Hz	230 1~ 50-60	230 1~ 50-60	115 1~ 60
Width	mm	259	259	259
Height	mm	260	260	260
Depth	mm	481	481	481
Max current	A	1.5	1.5	2.9
Inrush current	A	4	4	10
T Fuse	A	4	4	6
Power draw EN14511 - A35A35	W	270	230	280
Power draw EN14511 -A35A50	W	315	290	325
Operating cycle	-	100%	100%	100%
Electrical connection	-	4-pin plug	4-pin plug	4-pin plug
R134a Refrigerant	kg	0.17	0.29	0.17
Max refrigeration circuit pressure	bar	26	28	26
External air fan capacity	m ³ /h	330	330	330
Cabinet air fan capacity	m ³ /h	235	235	235
Internal temperature range	°C	20-50	20-50	20-50
Temperature regulation	-	Electronic thermostat, factory set to 35°C		
External temperature range	°C	20-55*	20-55*	20-50
EN60529 ingress protection - cabinet side	-	IP54	IP54	IP54
EN60529 ingress protection - ambient side	-	IP34	IP34	IP34
Noise level	dB (A)	60	65	60
Weight	kg	18	18	19
Colour	-	RAL 7035 embossed effect		
Conformity	-	CE	CE	CE

* 50 °C at 60 Hz

Accessories	
Pack of 5 fabric air filters	C15000171
Pack of 1 metal air filter	C15000172
Condensate level indicator	C16000140
External stainless-steel framework	
Coating in non-standard colour	

DEK08

Roof-mount air conditioners

COOLING CAPACITY

820 W

Performance

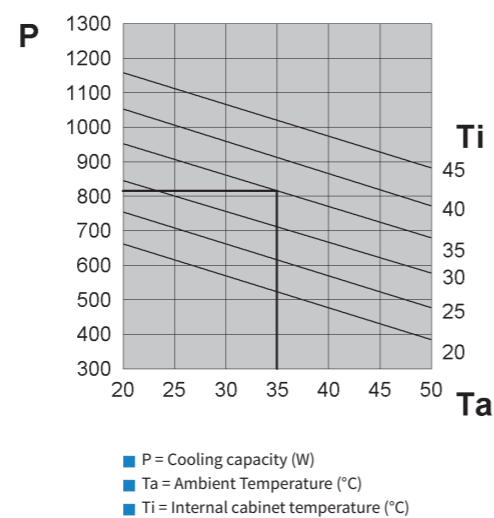

Dimensions

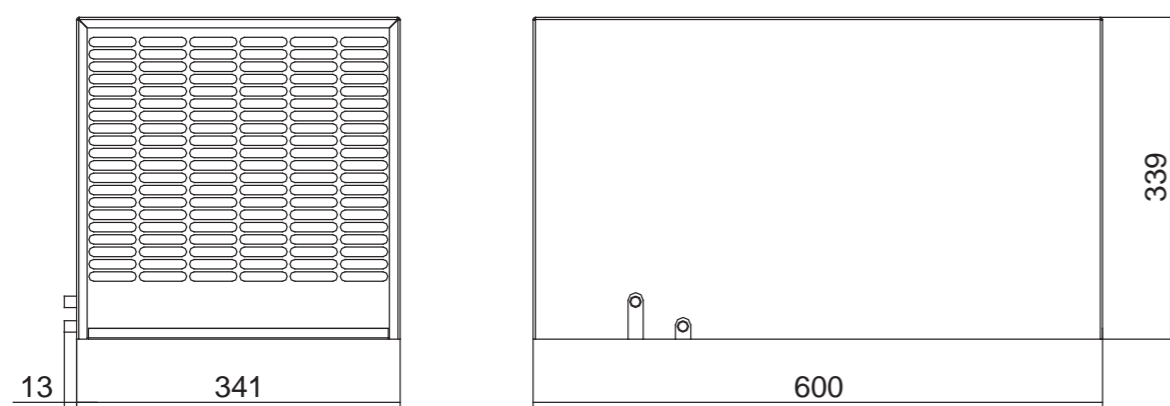

Features	UoM	DEK08BT0B	DEK08BTUB	DEK08CT0B	DEK08GT0B
Cooling capacity EN14511 - A35A35	W	820	820	820	820
Cooling capacity EN14511 - A35A50	W	680	680	680	680
Power supply	V ~ Hz	230 1~ 50-60	230 1~ 50-60	115 1~ 50-60	400/440 2~ 50-60
Width	mm	341	341	341	341
Height	mm	339	339	339	339
Depth	mm	600	600	600	600
Max current	A	2.9	3.5	5.7	1.7
Inrush current	A	12	12	19	7
T Fuse	A	6	6	10	4
Power draw EN14511 - A35A35	W	510	520	520	520
Power draw EN14511 -A35A50	W	560	590	570	570
Operating cycle	-	100%	100%	100%	100%
Electrical connection	-	4-pin plug	4-pin plug	4-pin plug	4-pin plug
R134a Refrigerant	kg	0.31	0.31	0.31	0.31
Max refrigeration circuit pressure	bar	25	28	25	25
External air fan capacity	m ³ /h	860	860	860	860
Cabinet air fan capacity	m ³ /h	570	570	570	570
Internal temperature range	°C	20-50	20-50	20-50	20-50
Temperature regulation	-	Electronic thermostat factory set to 35°C			
External temperature range	°C	20-55*	20-55*	20-50	20-50
EN60529 ingress protection - cabinet side	-	IP54	IP54	IP54	IP54
EN60529 ingress protection - ambient side	-	IP34	IP34	IP34	IP34
Noise level	dB (A)	62	65	62	62
Weight	kg	23	23	24	24
Colour	-	RAL 7035 embossed effect			
Conformity	-	CE	CE e RA US	CE	CE

* 50 °C at 60 Hz

Accessories	
Pack of 5 fabric air filters	C15000173
Pack of 1 metal air filter	C15000174
Condensate level indicator	C16000140
External stainless-steel framework	
Coating in non-standard colour	

DEK12

Roof-mount air conditioners

COOLING CAPACITY

1150 W

Performance

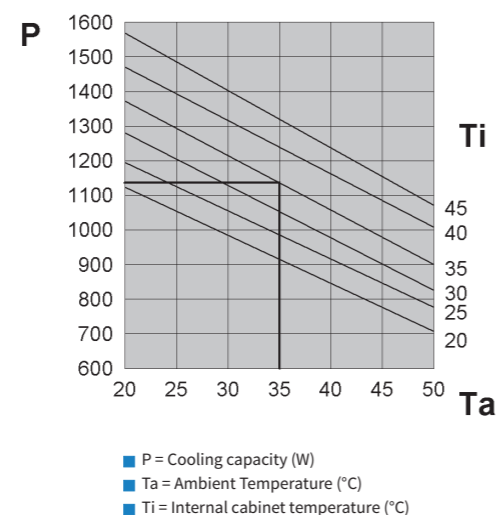

Dimensions

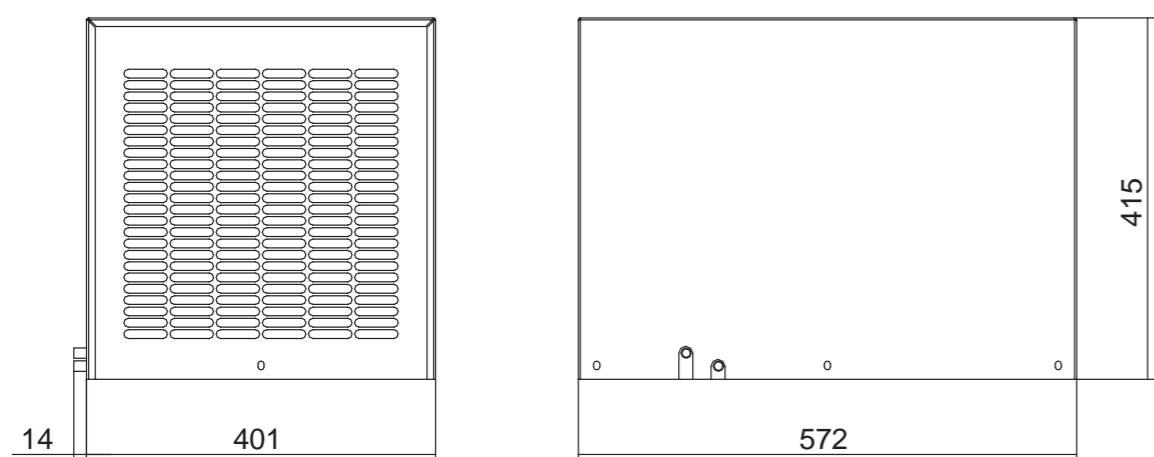

Features	UoM	DEK12BT0B	DEK12BTUB	DEK12CT0B	DEK12GT0B
Cooling capacity EN14511 - A35A35	W	1150	1150	1150	1150
Cooling capacity EN14511 - A35A50	W	900	900	900	900
Power supply	V - Hz	230 1~ 50-60	230 1~ 50-60	115 1~ 50-60	400/440 2~ 50-60
Width	mm	401	401	401	401
Height	mm	415	415	415	415
Depth	mm	572	572	572	572
Max current	A	3.2	4	6.4	2.2
Inrush current	A	11	11	22	8
T Fuse	A	6	6	12	6
Power draw EN14511 - A35A35	W	550	570	560	560
Power draw EN14511 -A35A50	W	660	690	670	670
Operating cycle	-	100%	100%	100%	100%
Electrical connection	-	4-pin plug	4-pin plug	4-pin plug	4-pin plug
R134a Refrigerant	kg	0.63	0.44	0.63	0.63
Max refrigeration circuit pressure	bar	25	28	25	25
External air fan capacity	m ³ /h	1010	1010	1010	1010
Cabinet air fan capacity	m ³ /h	570	570	570	570
Internal temperature range	°C	20-50	20-50	20-50	20-50
Temperature regulation	-	Electronic thermostat factory set to 35°C			
External temperature range	°C	20-55*	20-50	20-50	20-50
EN60529 ingress protection - cabinet side	-	IP54	IP54	IP54	IP54
EN60529 ingress protection - ambient side	-	IP34	IP34	IP34	IP34
Noise level	dB (A)	65	65	65	65
Weight	kg	40	40	42	42
Colour	-	RAL 7035 embossed effect			
Conformity	-	CE	CE e RA US	CE	CE

* 50 °C at 60 Hz

Accessories	
Pack of 5 fabric air filters	AADFP12
Pack of 1 metal air filter	AADFM12
Condensate level indicator	C16000140
External stainless-steel framework	
Coating in non-standard colour	

DEK15

Roof-mount air conditioners

COOLING CAPACITY

1550 W

Performance

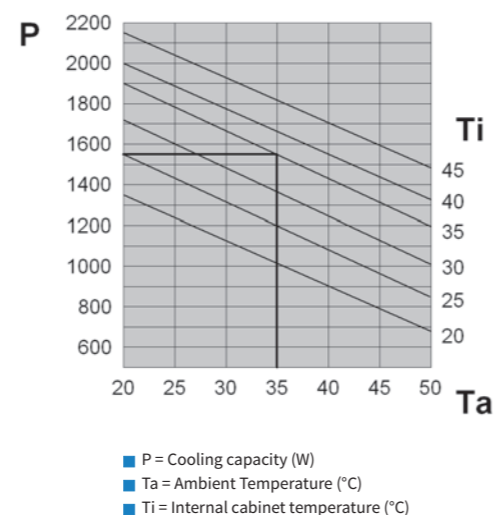

Dimensions

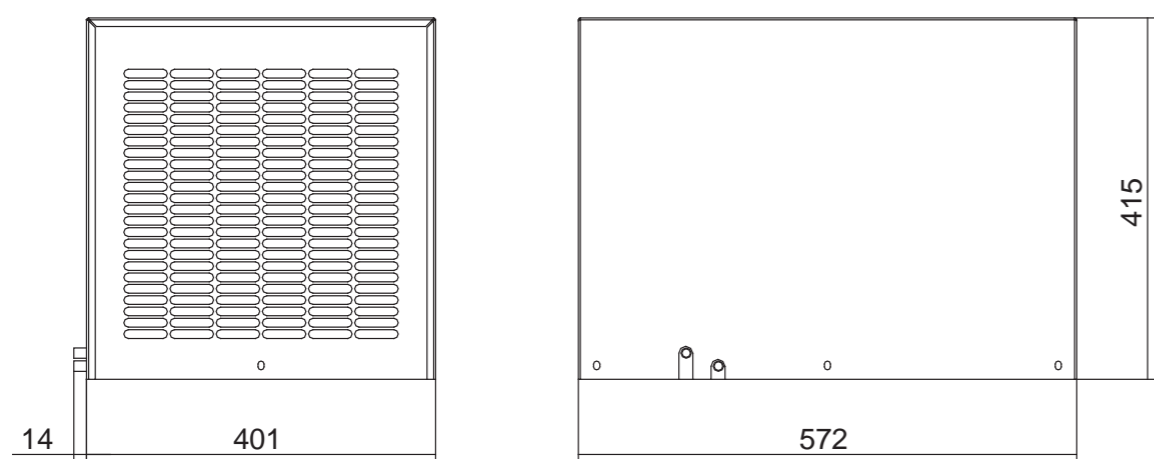

Features	UoM	DEK15BT0B	DEK15BTUB	DEK15CT0B	DEK15GT0B
Cooling capacity EN14511 - A35A35	W	1550	1550	1550	1550
Cooling capacity EN14511 - A35A50	W	1200	1200	1200	1200
Power supply	V - Hz	230 1~ 50-60	230 1~ 50-60	115 1~ 50-60	400/440 2~ 50-60
Width	mm	401	401	401	401
Height	mm	415	415	415	415
Depth	mm	572	572	572	572
Max current	A	4.5	5.5	10	2.8
Inrush current	A	18	18	39	9.6
T Fuse	A	8	10	16	4
Power draw EN14511 - A35A35	W	810	830	820	820
Power draw EN14511 -A35A50	W	930	960	940	940
Operating cycle	-	100%	100%	100%	100%
Electrical connection	-	4-pin plug	4-pin plug	4-pin plug	4-pin plug
R134a Refrigerant	kg	0.54	0.41	0.54	0.54
Max refrigeration circuit pressure	bar	25	28	25	25
External air fan capacity	m ³ /h	1820	1820	1820	1820
Cabinet air fan capacity	m ³ /h	860	860	860	860
Internal temperature range	°C	20-50	20-50	20-50	20-50
Temperature regulation	-	Electronic thermostat factory set to 35°C			
External temperature range	°C	20-55*	20-50	20-50	20-50
EN60529 ingress protection - cabinet side	-	IP54	IP54	IP54	IP54
EN60529 ingress protection - ambient side	-	IP34	IP34	IP34	IP34
Noise level	dB (A)	65	65	65	65
Weight	kg	44	44	46	46
Colour	-	RAL 7035 embossed effect			
Conformity	-	CE	CE e RA US	CE	CE

* 50 °C at 60 Hz

Accessories	
Pack of 5 fabric air filters	AADFP12
Pack of 1 metal air filter	AADFM12
Condensate level indicator	C16000140
External stainless-steel framework	
Coating in non-standard colour	

DEK20

Roof-mount air conditioners

COOLING CAPACITY

2050 W

Performance

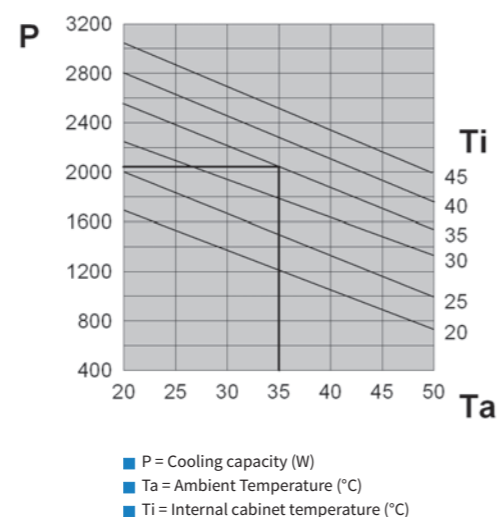

Dimensions

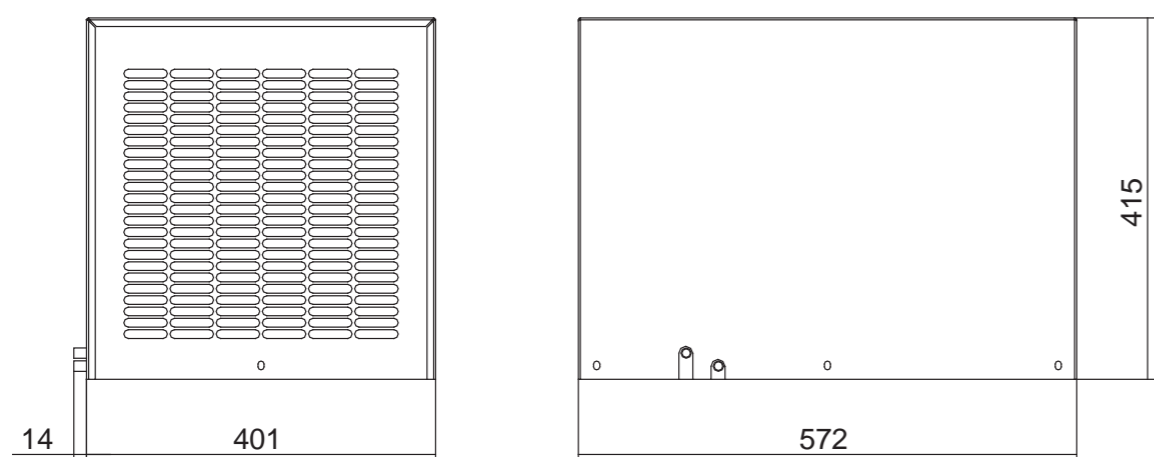

Features	UoM	DEK20BT0B	DEK20CT0B	DEK20LT0B	DEK20TUB
Cooling capacity EN14511 - A35A35	W	2050	2050	2050	2050
Cooling capacity EN14511 - A35A50	W	1560	1560	1560	1560
Power supply	V ~ Hz	230 1~ 50-60	115 1~ 50-60	400 3~ 50-60	460 3~ 60
Width	mm	401	401	401	401
Height	mm	415	415	415	415
Depth	mm	572	572	572	572
Max current	A	6	13.2	1.9	2.1
Inrush current	A	24	48	10	10
T Fuse	A	10	20	4	6
Power draw EN14511 - A35A35	W	1190	1220	990	1060
Power draw EN14511 -A35A50	W	1300	1320	1190	1290
Operating cycle	-	100%	100%	100%	100%
Electrical connection	-	4-pin plug	4-pin plug	4-pin plug	4-pin plug
R134a Refrigerant	kg	0.55	0.55	0.55	0.70
Max refrigeration circuit pressure	bar	25	25	25	28
External air fan capacity	m ³ /h	1820	1820	1820	1820
Cabinet air fan capacity	m ³ /h	1050	1050	1050	1050
Internal temperature range	°C	20-50	20-50	20-50	20-50
Temperature regulation	-	Electronic thermostat factory set to 35°C			
External temperature range	°C	20-55*	20-50	20-50	20-50
EN60529 ingress protection - cabinet side	-	IP54	IP54	IP54	IP54
EN60529 ingress protection - ambient side	-	IP34	IP34	IP34	IP34
Noise level	dB (A)	65	65	65	65
Weight	kg	50	56	52	52
Colour	-	RAL 7035 embossed effect			
Conformity	-	CE	CE	CE	CE

* 50 °C at 60 Hz

Accessories	
Pack of 5 fabric air filters	AADFP12
Pack of 1 metal air filter	AADFM12
Condensate level indicator	C16000140
External stainless-steel framework	
Coating in non-standard colour	

DEK30

Roof-mount air conditioners

COOLING CAPACITY

2900 W



Features	UoM	DEK30BT0B	DEK30LT0B	DEK30NTUB
Cooling capacity EN14511 - A35A35	W	2900	2900	2900
Cooling capacity EN14511 - A35A50	W	2250	2250	2250
Power supply	V ~ Hz	230 1~ 50-60	400 3~ 50-60	460 3~ 60
Width	mm	492	492	492
Height	mm	496	496	496
Depth	mm	784	784	784
Max current	A	8.2	2.5	3.3
Inrush current	A	38.4	15.7	15.7
T Fuse	A	16	6	6
Power draw EN14511 - A35A35	W	1350	1210	1310
Power draw EN14511 -A35A50	W	1610	1450	1750
Operating cycle	-	100%	100%	100%
Electrical connection	-	4-pin plug	4-pin plug	4-pin plug
R134a Refrigerant	kg	1.26	1.2	1.2
Max refrigeration circuit pressure	bar	25	25	28
External air fan capacity	m ³ /h	3410	3410	3410
Cabinet air fan capacity	m ³ /h	860	860	860
Internal temperature range	°C	20-50	20-50	20-50
Temperature regulation	-	Electronic thermostat, factory set to 35°C		
External temperature range	°C	20-50	20-50	20-50
EN60529 ingress protection - cabinet side	-	IP54	IP54	IP54
EN60529 ingress protection - ambient side	-	IP34	IP34	IP34
Noise level	dB (A)	75	75	75
Weight	kg	80	83	83
Colour	-	RAL 7035 embossed effect		
Conformity	-	CE	CE	CE

Accessories	
Pack of 5 fabric air filters	AADFP30
Pack of 1 metal air filter	AADFM30
Condensate level indicator	C16000140
External stainless-steel framework	
Coating in non-standard colour	

Performance

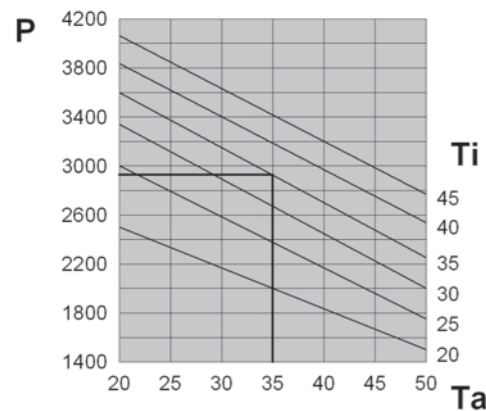

■ P = Cooling capacity (W)
 ■ Ta = Ambient Temperature (°C)
 ■ Ti = Internal cabinet temperature (°C)

Dimensions

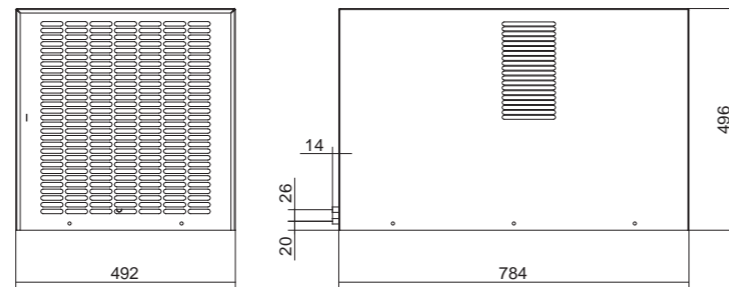

DEK40

Roof-mount air conditioners

COOLING CAPACITY

3850 W



Features	UoM	DEK40BT0B	DEK40LT0B	DEK40NTUB
Cooling capacity EN14511 - A35A35	W	3850	3850	3850
Cooling capacity EN14511 - A35A50	W	2870	2870	2870
Power supply	V ~ Hz	230 1~ 50-60	400 3~ 50-60	460 3~ 60
Width	mm	492	492	492
Height	mm	496	496	496
Depth	mm	784	784	784
Max current	A	9	3.4	4.3
Inrush current	A	38.2	17	17
T Fuse	A	18	6	6
Power draw EN14511 - A35A35	W	1690	1630	1950
Power draw EN14511 -A35A50	W	1950	1890	2160
Operating cycle	-	100%	100%	100%
Electrical connection	-	4-pin plug	4-pin plug	4-pin plug
R134a Refrigerant	kg	1.8	2	2
Max refrigeration circuit pressure	bar	25	25	25
External air fan capacity	m ³ /h	3410	3410	3410
Cabinet air fan capacity	m ³ /h	1450	1450	1450
Internal temperature range	°C	20-50	20-50	20-50
Temperature regulation	-	Electronic thermostat, factory set to 35°C		
External temperature range	°C	20-50	20-50	20-50
EN60529 ingress protection - cabinet side	-	IP54	IP54	IP54
EN60529 ingress protection - ambient side	-	IP34	IP34	IP34
Noise level	dB (A)	75	75	75
Weight	kg	83	86	86
Colour	-	RAL 7035 embossed effect		
Conformity	-	CE	CE	CE

Accessories	
Pack of 5 fabric air filters	AADFP30
Pack of 1 metal air filter	AADFM30
Condensate level indicator	C16000140
External stainless-steel framework	
Coating in non-standard colour	

Performance

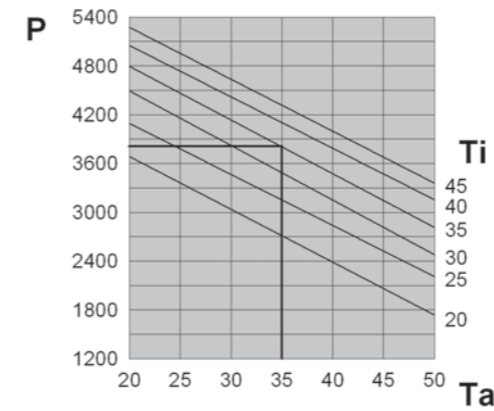

■ P = Cooling capacity (W)
 ■ Ta = Ambient Temperature (°C)
 ■ Ti = Internal cabinet temperature (°C)

Dimensions

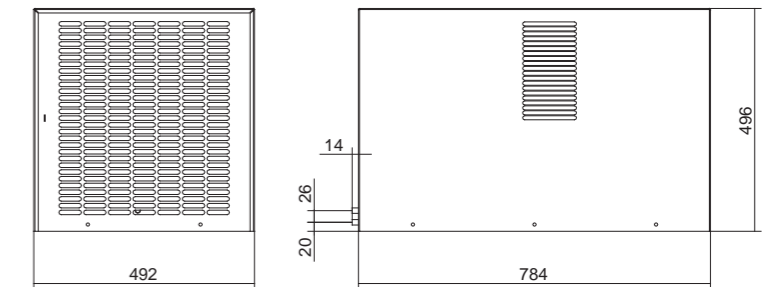

EMO

Wall-mount air conditioners for outdoor applications

texa industries' solution for outdoor installations; a coupling system to the electrical cabinet which guarantees maximum protection even under the most demanding environmental conditions.



WIDE RANGE OF POWER OUTPUTS

The available power outputs range from 400 to 9400 W, covering most electrical cabinet cooling requirements in an extremely compact size.

REGULATION AND SAFETY DEVICES

EMO air conditioning systems are equipped with electromechanical thermostatic regulation which guarantees maximum reliability even in extreme conditions. The refrigeration circuit is protected by low- and high-pressure safety pressure switches with automatic rearming. A fixed calibration pressure switch with ON/OFF contact manages the condensing fan.

QUICK INSTALLATION

Installation is very quick by simply drilling the cabinet panel and fastening systems which are included in the air conditioner package. This features provisions for the electrical connections to be made quickly and safely using fast connectors inserted in the rear of the unit.

IDEAL COOLING FOR THE UNIT

The air inside the cabinet is taken in from the upper part of the cabinet, cooled inside the air conditioner and directed back into the cabinet with a high-speed flow directed towards the bottom. This ensures both optimum cooling of the entire cabinet and the prevention of hot points in the electronic components.

REDUCED MAINTENANCE

All units are equipped with heat exchange surfaces designed to prevent clogging by solid contaminants present in the ambient air. The condensing coils are protected by a cataphoresis treatment which prevents fouling and corrosion. They maintain high levels of efficiency even in demanding environmental conditions, drastically reducing maintenance requirements and thus allowing the air conditioner to operate without an external air filter.

IP55 CABINET INGRESS PROTECTION

Thanks to the special internal configuration, which separates the external and internal air flows in a sealed manner, and the new self-adhesive coupling gasket, EMO air conditioners (from the EMO 04 model to the EMO 40 model) allow the cabinet to retain an IP55 rating.

RESPECT FOR THE ENVIRONMENT

Reduction of noise levels is a precise criterion aimed for when developing EMO air conditioners. They have been designed to minimise disturbance from noise. To help protect the environment, these air conditioners use R134a or R407C CFC-free refrigerant, which do not damage the ozone layer.

SUPPLY VOLTAGE

EMO air conditioners are available for the most common AC voltages: 230V single phase, 400-440V two phase (for concatenated voltage power supply when neutral is not present), 115V single phase, 400V three phase, all in 50-60 Hz dual frequency versions, and 400V and 460V three phase single frequency (50 or 60 Hz) versions. On request, versions for voltages not present in the catalogue can be produced for orders of sufficient quantities.

FRAMEWORK AND COATING

The framework is made of coated steel sheet. The coating is epoxy powder coating. The standard colour is RAL 7035 textured. Non-standard colours and stainless-steel versions are available on request. Rubber grommets and heatshrink sleeves protect the external electrical connections, making them suitable for outdoor use. The exterior electrical connections all have an IP54 rating.

OPERATING TEMPERATURE

The possible operating temperatures range from -20 to +55°C. The temperature inside the cabinet can be adjusted from +20 to +46°C (the air conditioner is factory set to +35°C).

OPTIONAL ACCESSORIES

EMO air conditioners offer various optional accessories:

- Stainless-steel framework
- Evaporating fan with separate 48VDC power supply
- Tamper-resistant screw kit for front casing closure
- High temperature alarm warning
- Common high/low pressure alarm



Application tips

- When choosing an air conditioner, keep a margin of safety of at least 10% for the power output, taking the most demanding conditions of operation into account.
- Seal the cabinet well. Any cracks or other openings would significantly reduce the efficiency of the air conditioner and produce excessive amounts of condensate.
- The air conditioner may be installed on the door or the wall, but always in the highest possible position in order to ensure that air is taken in from the top part of the cabinet, where there is a high temperature area.
- The air conditioner is factory set to 35°C, the optimum temperature for most applications. Unless strictly necessary, avoiding lowering this temperature because it would reduce the efficiency of the air conditioner and cause excessive condensate production.
- Try to facilitate the air flow inside the electrical cabinet when designing the layout of the components. Avoid blocking the air inlet or outlet with components installed too close together. Any components with internal ventilation of their own must have their air flow arranged so as to not impede the air flow of the air conditioner.
- Disable the air conditioner if the cabinet doors are opened to prevent excessive condensate production. Install a limit switch on the door for this purpose.
- The air conditioner power supply line must be protected with a time delay fuse or circuit breaker of suitable size on the basis of the unit's technical data.

EMO04

Wall-mount air conditioners for outdoor applications

COOLING CAPACITY

380 W



Accessories	
Pack of 5 fabric air filters	AAEFP04
Pack of 1 metal air filter	AAEFM04
External stainless-steel framework	
Coating in non-standard colour	
48VDC evaporator fan	
Anti-tamper screw kit	
High temperature alarm	
Pressure alarms (low, high)	

Features	UoM	EMO04BM1B	EMO04CM1B
Cooling capacity EN14511 - A35A35	W	380	380
Cooling capacity EN14511 - A35A50	W	240	240
Power supply	V ~ Hz	230 1~ 50-60	115 1~ 50-60
Width	mm	300	300
Height	mm	572	572
Depth	mm	205	205+35***
Max current	A	1.6	3.2
Inrush current	A	6	11
T Fuse	A	4	6
Power draw EN14511 - A35A35	W	230	240
Power draw EN14511 -A35A50	W	260	270
Operating cycle	-	100%	100%
Electrical connection	-	4-pin plug	4-pin plug
R134a Refrigerant	kg	0.13	0.13
Max refrigeration circuit pressure	bar	26	26
External air fan capacity	m ³ /h	280	280
Cabinet air fan capacity	m ³ /h	280	280
Internal temperature range	°C	+20 - +46	+20 - +46
Temperature regulation	-	Electromechanical thermostat, factory set to 35°C	
External temperature range	°C	-20 - +55**	-20 - +50
EN60529 ingress protection - cabinet side	-	IP55	IP55
EN60529 ingress protection - ambient side	-	IP34*	IP34*
Noise level	dB (A)	60	60
Weight	kg	17	18
Colour	-	RAL 7035 embossed effect	
Conformity	-	CE	CE

*** Due to external autotransformer dimensions ** 50 °C at 60 Hz

* IP54 rated exterior electrical connections



Performance

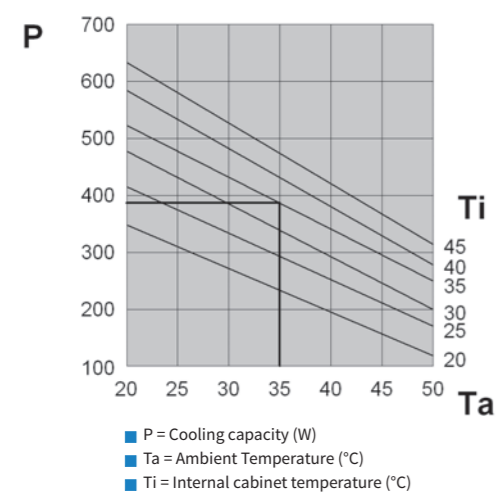

Dimensions

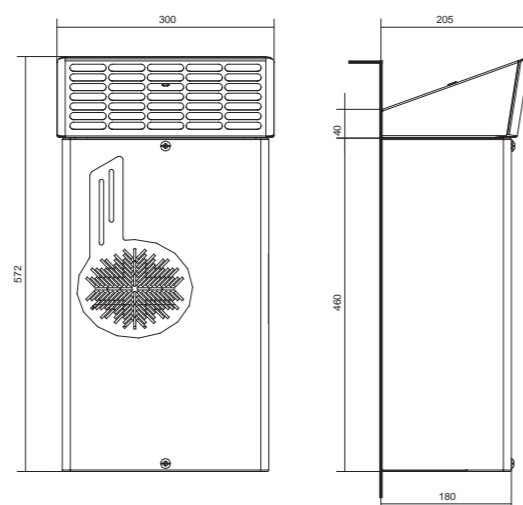

EMO06

Wall-mount air conditioners for outdoor applications

COOLING CAPACITY

640 W

Performance

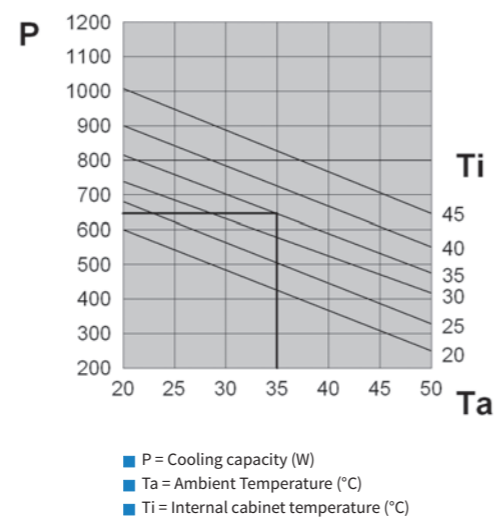

Dimensions

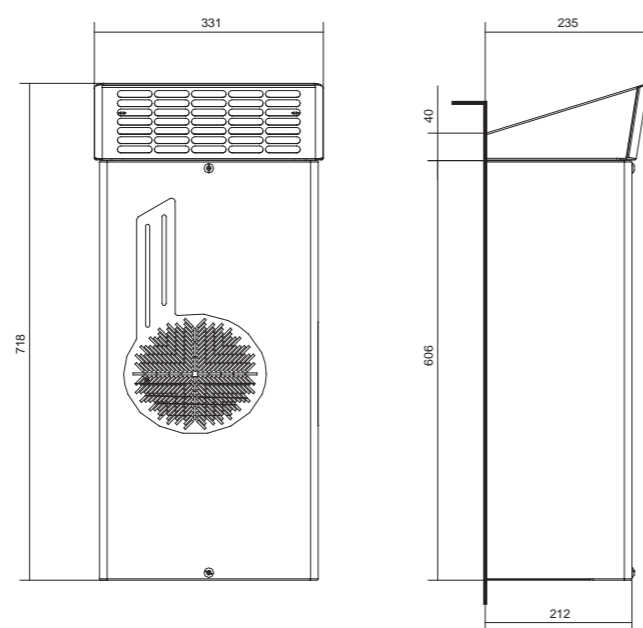

Features	UoM	EMO06BM1B	EMO06CM1B	EMO06GM1B	EMO06VM1B
Cooling capacity EN14511 - A35A35	W	640	640	640	500
Cooling capacity EN14511 - A35A50	W	470	470	470	340
Power supply	V ~ Hz	230 1~ 50-60	115 1~ 50-60	400/440 2~ 50-60	48 V DC
Width	mm	331	331	331	331
Height	mm	718	718	718	718
Depth	mm	235	235+42***	235+58***	235
Max current	A	2.1	4.4	1.2	5.8
Inrush current	A	8.1	16	5	-
T Fuse	A	6	8	2	10
Power draw EN14511 - A35A35	W	380	390	390	280
Power draw EN14511 - A35A50	W	420	430	430	310
Operating cycle	-	100%	100%	100%	100%
Electrical connection	-	4-pin plug	4-pin plug	4-pin plug	4-pin plug
R134a Refrigerant	kg	0.19	0.19	0.19	0.23
Max refrigeration circuit pressure	bar	25	25	25	25
External air fan capacity	m ³ /h	570	570	570	570
Cabinet air fan capacity	m ³ /h	330	330	330	370
Internal temperature range	°C	+20 - +46	+20 - +46	+20 - +46	+20 - +46
Temperature regulation	-	Electromechanical thermostat, factory set to 35°C			
External temperature range	°C	-20 - +55**	-20 - +50	-20 - +50	-20 - +50
EN60529 ingress protection - cabinet side	-	IP55	IP55	IP55	IP55
EN60529 ingress protection - ambient side	-	IP34*	IP34*	IP34*	IP34*
Noise level	dB (A)	65	65	65	65
Weight	kg	21	22	22	21
Colour	-	RAL 7035 embossed effect			
Conformity	-	CE	CE	CE	CE

Accessories	
Pack of 5 fabric air filters	AAEFP06
Pack of 1 metal air filter	AAEFM06
External stainless-steel framework	
Coating in non-standard colour	
48VDC evaporator fan	
Anti-tamper screw kit	
High temperature alarm	
Pressure alarms (low, high)	

* IP54 rated exterior electrical connections
 ** 50 °C at 60 Hz
 *** Due to external autotransformer dimensions

EMO08

Wall-mount air conditioners for outdoor applications

COOLING CAPACITY

820 W



Features	UoM	EMO08BM1B	EMO08CM1B	EMO08GM1B
Cooling capacity EN14511 - A35A35	W	820	820	820
Cooling capacity EN14511 - A35A50	W	680	680	680
Power supply	V ~ Hz	230 1~ 50-60	115 1~ 50-60	400/440 2~ 50-60
Width	mm	363	363	363
Height	mm	895	895	895
Depth	mm	239	239+42***	239+58***
Max current	A	2.6	5.3	1.7
Inrush current	A	10.8	21.5	6.1
T Fuse	A	6	10	6
Power draw EN14511 - A35A35	W	410	420	420
Power draw EN14511 -A35A50	W	490	500	500
Operating cycle	-	100%	100%	100%
Electrical connection	-	4-pin plug	4-pin plug	4-pin plug
R134a Refrigerant	kg	0.21	0.21	0.21
Max refrigeration circuit pressure	bar	25	25	25
External air fan capacity	m ³ /h	570	570	570
Cabinet air fan capacity	m ³ /h	330	330	330
Internal temperature range	°C	+20 - +46	+20 - +46	+20 - +46
Temperature regulation	-	Electromechanical thermostat, factory set to 35°C		
External temperature range	°C	-20 - +55**	-20 - +50	-20 - +50
EN60529 ingress protection - cabinet side	-	IP55	IP55	IP55
EN60529 ingress protection - ambient side	-	IP34*	IP34*	IP34*
Noise level	dB (A)	65	65	65
Weight	kg	27	28	28
Colour	-	RAL 7035 embossed effect		
Conformity	-	CE	CE	CE

*** Due to external autotransformer dimensions ** 50 °C at 60 Hz

* IP54 rated exterior electrical connections

Accessories	
Pack of 5 fabric air filters	AAEFP10
Pack of 1 metal air filter	AAEFM10
External stainless-steel framework	
Coating in non-standard colour	
48VDC evaporator fan	
Anti-tamper screw kit	
High temperature alarm	
Pressure alarms (low, high)	

Performance

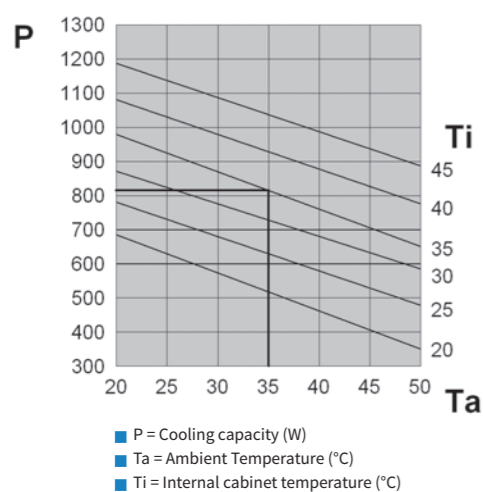

Dimensions

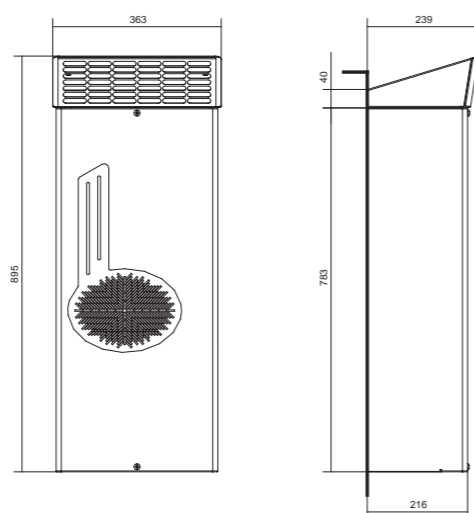

EMO10

Wall-mount air conditioners for outdoor applications

COOLING CAPACITY

1000 W



Features	UoM	EMO10BM1B	EMO10CM1B	EMO10GM1B
Cooling capacity EN14511 - A35A35	W	1000	1000	1000
Cooling capacity EN14511 - A35A50	W	790	790	790
Power supply	V ~ Hz	230 1~ 50-60	115 1~ 50-60	400/440 2~ 50-60
Width	mm	363	363	363
Height	mm	895	895	895
Depth	mm	239	239+42***	239+58***
Max current	A	3	6.7	2
Inrush current	A	10.5	23	8
T Fuse	A	6	10	4
Power draw EN14511 - A35A35	W	470	490	490
Power draw EN14511 -A35A50	W	560	580	580
Operating cycle	-	100%	100%	100%
Electrical connection	-	4-pin plug	4-pin plug	4-pin plug
R134a Refrigerant	kg	0.2	0.2	0.2
Max refrigeration circuit pressure	bar	25	25	25
External air fan capacity	m ³ /h	570	570	570
Cabinet air fan capacity	m ³ /h	330	330	330
Internal temperature range	°C	+20 - +46	+20 - +46	+20 - +46
Temperature regulation	-	Electromechanical thermostat, factory set to 35°C		
External temperature range	°C	-20 - +55**	-20 - +50	-20 - +50
EN60529 ingress protection - cabinet side	-	IP55	IP55	IP55
EN60529 ingress protection - ambient side	-	IP34*	IP34*	IP34*
Noise level	dB (A)	65	65	65
Weight	kg	28	29	29
Colour	-	RAL 7035 embossed effect		
Conformity	-	CE	CE	CE

*** Due to external autotransformer dimensions ** 50 °C at 60 Hz

* IP54 rated exterior electrical connections

Accessories	
Pack of 5 fabric air filters	AAEFP10
Pack of 1 metal air filter	AAEFM10
External stainless-steel framework	
Coating in non-standard colour	
48VDC evaporator fan	
Anti-tamper screw kit	
High temperature alarm	
Pressure alarms (low, high)	

Performance

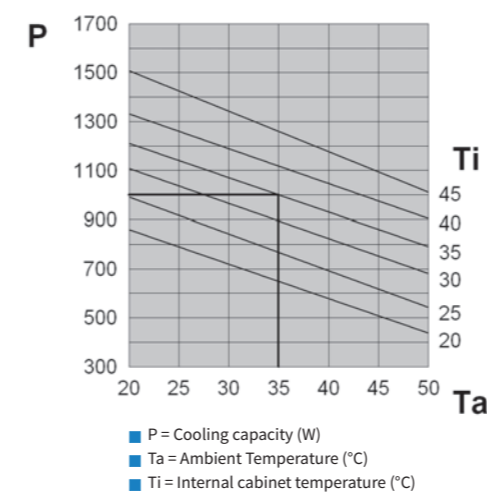

Dimensions

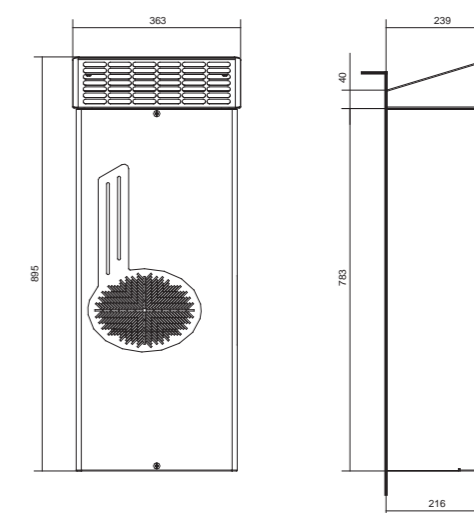

EMO12

Wall-mount air conditioners for outdoor applications

COOLING CAPACITY

1250 W



Features	UoM	EMO12BM1B	EMO12CM1B	EMO12GM1B
Cooling capacity EN14511 - A35A35	W	1250	1250	1250
Cooling capacity EN14511 - A35A50	W	910	910	910
Power supply	V ~ Hz	230 1~ 50-60	115 1~ 50-60	400/440 2~ 50-60
Width	mm	415	415	415
Height	mm	1109	1109	1109
Depth	mm	261	261	261
Max current	A	3.8	7.6	2.2
Inrush current	A	11	24	8.5
T Fuse	A	6	10	4
Power draw EN14511 - A35A35	W	680	690	690
Power draw EN14511 -A35A50	W	790	800	800
Operating cycle	-	100%	100%	100%
Electrical connection	-	4-pin plug	4-pin plug	4-pin plug
R134a Refrigerant	kg	0.26	0.26	0.26
Max refrigeration circuit pressure	bar	25	25	25
External air fan capacity	m ³ /h	860	860	860
Cabinet air fan capacity	m ³ /h	570	570	570
Internal temperature range	°C	+20 - +46	+20 - +46	+20 - +46
Temperature regulation	-	Electromechanical thermostat, factory set to 35°C		
External temperature range	°C	-20 - +55**	-20 - +50	-20 - +50
EN60529 ingress protection - cabinet side	-	IP55	IP55	IP55
EN60529 ingress protection - ambient side	-	IP34*	IP34*	IP34*
Noise level	dB (A)	65	65	65
Weight	kg	38	40	40
Colour	-	RAL 7035 embossed effect		
Conformity	-	CE	CE	CE

** 50 °C at 60 Hz

* IP54 rated exterior electrical connections

Accessories	
Pack of 5 fabric air filters	C15000163
Pack of 1 metal air filter	C15000164
External stainless-steel framework	
Coating in non-standard colour	
48VDC evaporator fan	
Anti-tamper screw kit	
High temperature alarm	
Pressure alarms (low, high)	

Performance

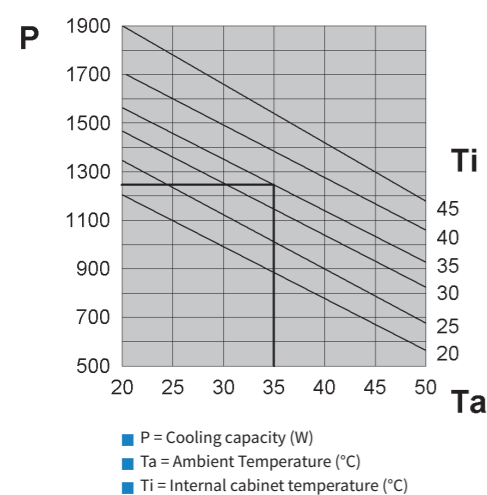

Dimensions

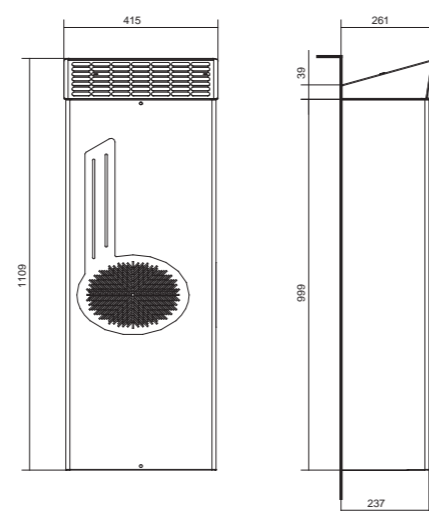

EMO16

Wall-mount air conditioners for outdoor applications

COOLING CAPACITY

1600 W



Features	UoM	EMO16BM1B	EMO16CM1B	EMO16GM1B
Cooling capacity EN14511 - A35A35	W	1600	1600	1600
Cooling capacity EN14511 - A35A50	W	1230	1230	1230
Power supply	V ~ Hz	230 1~ 50-60	115 1~ 50-60	400/440 2~ 50-60
Width	mm	415	415	415
Height	mm	1109	1109	1109
Depth	mm	261	261	261
Max current	A	5.3	12.9	2.9
Inrush current	A	18	39	11
T Fuse	A	10	20	6
Power draw EN14511 - A35A35	W	820	840	840
Power draw EN14511 -A35A50	W	940	960	960
Operating cycle	-	100%	100%	100%
Electrical connection	-	4-pin plug	4-pin plug	4-pin plug
R134a Refrigerant	kg	0.33	0.33	0.33
Max refrigeration circuit pressure	bar	25	25	25
External air fan capacity	m ³ /h	1050	1050	1050
Cabinet air fan capacity	m ³ /h	570	570	570
Internal temperature range	°C	+20 - +46	+20 - +46	+20 - +46
Temperature regulation	-	Electromechanical thermostat, factory set to 35°C		
External temperature range	°C	-20 - +55**	-20 - +50	-20 - +50
EN60529 ingress protection - cabinet side	-	IP55	IP55	IP55
EN60529 ingress protection - ambient side	-	IP34*	IP34*	IP34*
Noise level	dB (A)	65	65	65
Weight	kg	40	42	42
Colour	-	RAL 7035 embossed effect		
Conformity	-	CE	CE	CE

** 50 °C at 60 Hz

* IP54 rated exterior electrical connections

Accessories	
Pack of 5 fabric air filters	C15000163
Pack of 1 metal air filter	C15000164
External stainless-steel framework	
Coating in non-standard colour	
48VDC evaporator fan	
Anti-tamper screw kit	
High temperature alarm	
Pressure alarms (low, high)	

Performance

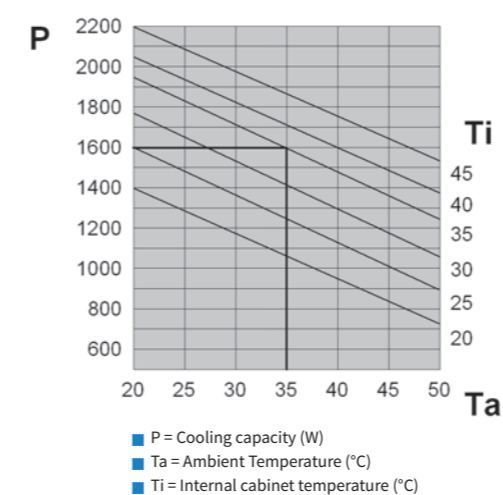

Dimensions

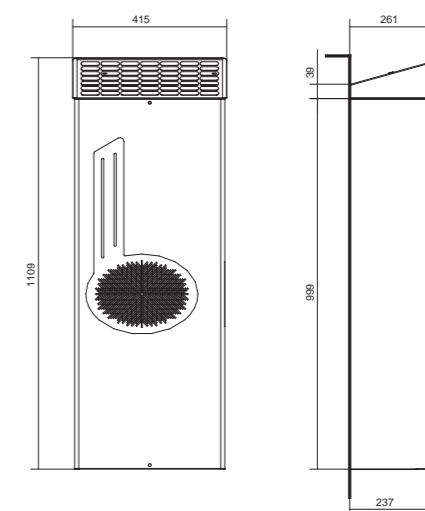

COOLING CAPACITY

2000 W

Performance

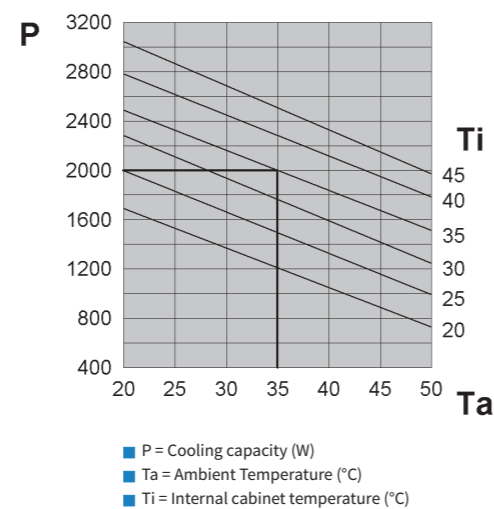

Dimensions

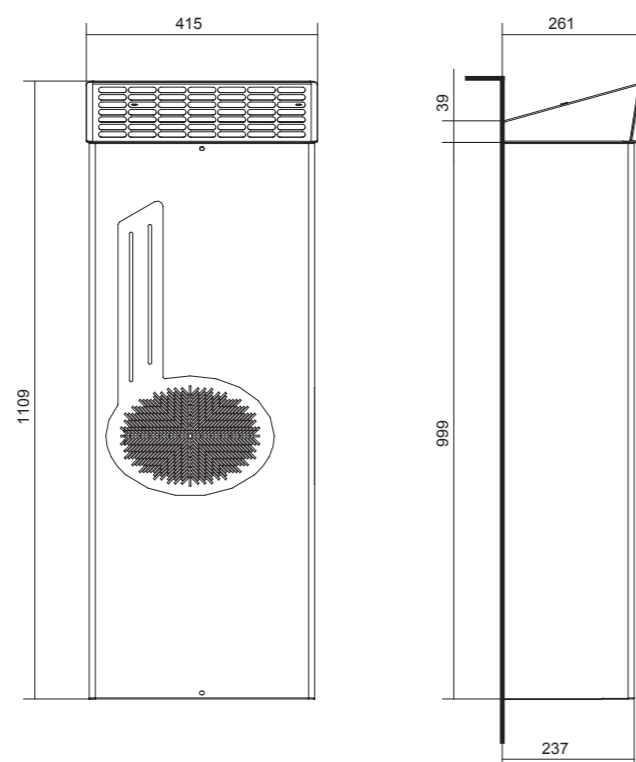

Features	UoM	EMO20BM1B	EMO20CM1B	EMO20LM1B	EMO20VM1B
Cooling capacity EN14511 - A35A35	W	2000	2000	2000	2000
Cooling capacity EN14511 - A35A50	W	1510	1510	1510	1510
Power supply	V ~ Hz	230 1~ 50-60	115 1~ 50-60	400 3~ 50-60	48 V DC
Width	mm	415	415	415	415
Height	mm	1109	1109	1109	1109
Depth	mm	261	261	261	261
Max current	A	6.5	13.3	2.5	21.6
Inrush current	A	24	48	10	-
T Fuse	A	10	20	6	26
Power draw EN14511 - A35A35	W	1030	1070	1070	986
Power draw EN14511 -A35A50	W	1180	1210	1210	1037
Operating cycle	-	100%	100%	100%	100%
Electrical connection	-	4-pin plug	4-pin plug	4-pin plug	4-pin plug
R134a Refrigerant	kg	0.43	0.43	0.45	0.42
Max refrigeration circuit pressure	bar	25	25	25	25
External air fan capacity	m ³ /h	1050	1050	1050	1050
Cabinet air fan capacity	m ³ /h	860	860	860	860
Internal temperature range	°C	+20 - +46	+20 - +46	+20 - +46	+20 - +46
Temperature regulation	-	Electromechanical thermostat, factory set to 35°C			
External temperature range	°C	-20 - +55**	-20 - +50	-20 - +50	-20 - +50
EN60529 ingress protection - cabinet side	-	IP55	IP55	IP55	IP55
EN60529 ingress protection - ambient side	-	IP34*	IP34*	IP34*	IP34*
Noise level	dB (A)	65	65	65	74
Weight	kg	52	54	54	48
Colour	-	RAL 7035 embossed effect			
Conformity	-	CE	CE	CE	CE

Accessories

Pack of 5 fabric air filters	C15000163
Pack of 1 metal air filter	C15000164
External stainless-steel framework	
Coating in non-standard colour	
48VDC evaporator fan	
Anti-tamper screw kit	
High temperature alarm	
Pressure alarms (low, high)	

* IP54 rated exterior electrical connections

** 50 °C at 60 Hz

EMO30

Wall-mount air conditioners for outdoor applications

COOLING CAPACITY

2900 W



Features	UoM	EMO30BM1B	EMO30LM1B
Cooling capacity EN14511 - A35A35	W	2900	2900
Cooling capacity EN14511 - A35A50	W	2250	2250
Power supply	V ~ Hz	230 1~ 50-60	400 3~ 50-60
Width	mm	512	512
Height	mm	1417	1417
Depth	mm	365	365
Max current	A	8.2	2.6
Inrush current	A	37.4	14
T Fuse	A	16	6
Power draw EN14511 - A35A35	W	1340	1220
Power draw EN14511 -A35A50	W	1560	1440
Operating cycle	-	100%	100%
Electrical connection	-	4-pin plug	4-pin plug
R134a Refrigerant	kg	0.57	0.62
Max refrigeration circuit pressure	bar	25	25
External air fan capacity	m ³ /h	1450	1450
Cabinet air fan capacity	m ³ /h	1450	1450
Internal temperature range	°C	+20 - +46	+20 - +46
Temperature regulation	-	Electromechanical thermostat, factory set to 35°C	
External temperature range	°C	-20 - +50	-20 - +50
EN60529 ingress protection - cabinet side	-	IP55	IP55
EN60529 ingress protection - ambient side	-	IP34*	IP34*
Noise level	dB (A)	70	70
Weight	kg	80	84
Colour	-	RAL 7035 embossed effect	
Conformity	-	CE	CE

Accessories	
Pack of 5 fabric air filters	C15000183
Pack of 1 metal air filter	C15000185
External stainless-steel framework	
Coating in non-standard colour	
48VDC evaporator fan	
Anti-tamper screw kit	
High temperature alarm	
Pressure alarms (low, high)	

* IP54 rated exterior electrical connections

Performance

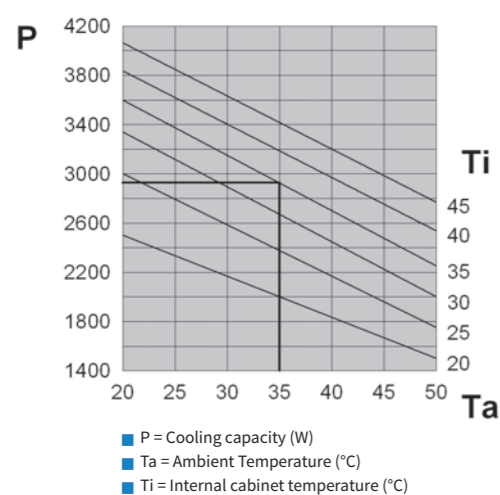

Dimensions

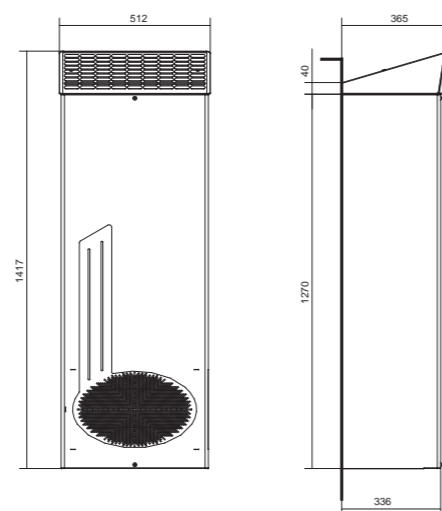

EMO40

Wall-mount air conditioners for outdoor applications

COOLING CAPACITY

3850 W



Features	UoM	EMO40BM1B	EMO40LM1B
Cooling capacity EN14511 - A35A35	W	3850	3850
Cooling capacity EN14511 - A35A50	W	2870	2870
Power supply	V ~ Hz	230 1~ 50-60	400 3~ 50-60
Width	mm	512	512
Height	mm	1417	1417
Depth	mm	365	365
Max current	A	9.5	3.6
Inrush current	A	35.2	18
T Fuse	A	16	8
Power draw EN14511 - A35A35	W	1710	1780
Power draw EN14511 -A35A50	W	1990	2050
Operating cycle	-	100%	100%
Electrical connection	-	4-pin plug	4-pin plug
R134a Refrigerant	kg	0.69	0.69
Max refrigeration circuit pressure	bar	25	25
External air fan capacity	m ³ /h	1450	1450
Cabinet air fan capacity	m ³ /h	1450	1450
Internal temperature range	°C	+20 - +46	+20 - +46
Temperature regulation	-	Electromechanical thermostat, factory set to 35°C	
External temperature range	°C	-20 - +50	-20 - +50
EN60529 ingress protection - cabinet side	-	IP55	IP55
EN60529 ingress protection - ambient side	-	IP34*	IP34*
Noise level	dB (A)	70	70
Weight	kg	82	85
Colour	-	RAL 7035 embossed effect	
Conformity	-	CE	CE

Accessories	
Pack of 5 fabric air filters	C15000183
Pack of 1 metal air filter	C15000185
External stainless-steel framework	
Coating in non-standard colour	
48VDC evaporator fan	
Anti-tamper screw kit	
High temperature alarm	
Pressure alarms (low, high)	

* IP54 rated exterior electrical connections

Performance

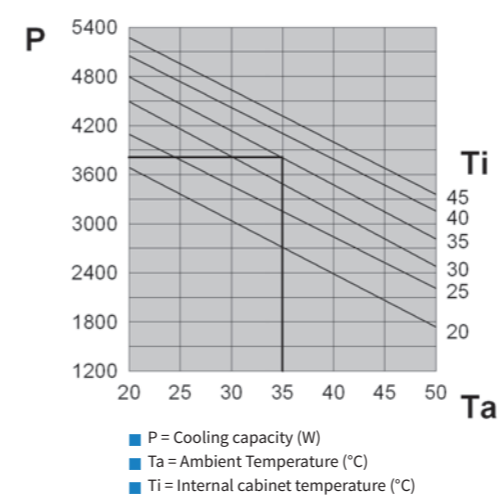

Dimensions

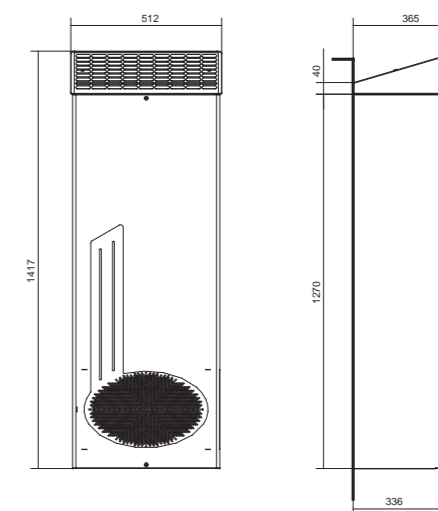

EMO60

Wall-mount air conditioners for outdoor applications

COOLING CAPACITY

5800 - 6050 W



Features	UoM	EMO60MMEB	EMO60NMEB
Cooling capacity EN14511 - A35A35	W	5800	6050
Cooling capacity EN14511 - A35A50	W	4350	4530
Power supply	V ~ Hz	400 3~ 50	460 3~ 60
Width	mm	600	600
Height	mm	2000	2000
Depth	mm	387	387
Max current	A	5.9	6.8
Inrush current	A	21.7	23.5
T Fuse	A	8	8
Power draw EN14511 - A35A35	W	2340	2920
Power draw EN14511 - A35A50	W	3880	4520
Operating cycle	-	100%	100%
Electrical connection	-	Cable L = 3 m	Cable L = 3 m
R407C Refrigerant	kg	1.8	1.8
Max refrigeration circuit pressure	bar	27	27
External air fan capacity	m ³ /h	2900	2900
Cabinet air fan capacity	m ³ /h	1450	1450
Internal temperature range	°C	+20 - +46	+20 - +46
Temperature regulation	-	Electromechanical thermostat, factory set to 35°C	
External temperature range	°C	-20 - +50	-20 - +50
EN60529 ingress protection - cabinet side	-	IP54	IP54
EN60529 ingress protection - ambient side	-	IP34*	IP34*
Noise level	dB (A)	72	72
Weight	kg	150	150
Colour	-	RAL 7035 embossed effect	
Conformity	-	CE	CE

Accessories	
Pack of 5 fabric air filters	C15000175
Pack of 1 metal air filter	C15000176
External stainless-steel framework	
Coating in non-standard colour	
48VDC evaporator fan	
Anti-tamper screw kit	
High temperature alarm	
Pressure alarms (low, high)	

* IP54 rated exterior electrical connections

Performance (EMO60MMEB)

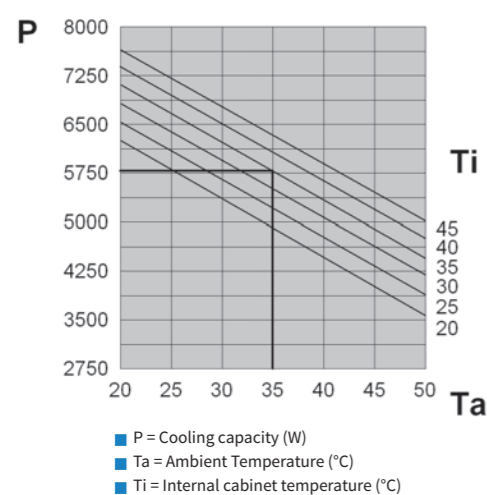

Dimensions

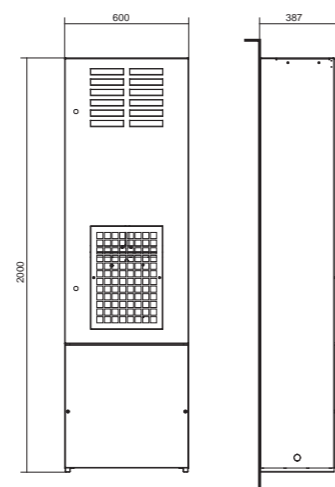

EMO80

Wall-mount air conditioners for outdoor applications

COOLING CAPACITY

7600 - 7950 W



Features	UoM	EMO80MMEB	EMO80NMEB
Cooling capacity EN14511 - A35A35	W	7600	7950
Cooling capacity EN14511 - A35A50	W	5700	5930
Power supply	V ~ Hz	400 3~ 50	460 3~ 60
Width	mm	800	800
Height	mm	2000	2000
Depth	mm	387	387
Max current	A	8.1	9.3
Inrush current	A	30.7	32.5
T Fuse	A	16	16
Power draw EN14511 - A35A35	W	3300	4035
Power draw EN14511 - A35A50	W	4910	5845
Operating cycle	-	100%	100%
Electrical connection	-	Cable L = 3 m	Cable L = 3 m
R134a Refrigerant	kg	2.8	2.8
Max refrigeration circuit pressure	bar	27	27
External air fan capacity	m ³ /h	2900	2900
Cabinet air fan capacity	m ³ /h	2900	2900
Internal temperature range	°C	+20 - +46	+20 - +46
Temperature regulation	-	Electromechanical thermostat, factory set to 35°C	
External temperature range	°C	-20 - +50	-20 - +50
EN60529 ingress protection - cabinet side	-	IP54	IP54
EN60529 ingress protection - ambient side	-	IP34*	IP34*
Noise level	dB (A)	75	75
Weight	kg	160	160
Colour	-	RAL 7035 embossed effect	
Conformity	-	CE	CE

Accessories	
Pack of 5 fabric air filters	C15000188
Pack of 1 metal air filter	C15000189
External stainless-steel framework	
Coating in non-standard colour	
48VDC evaporator fan	
Anti-tamper screw kit	
High temperature alarm	
Pressure alarms (low, high)	

* IP54 rated exterior electrical connections

Performance (EMO80MMEB)

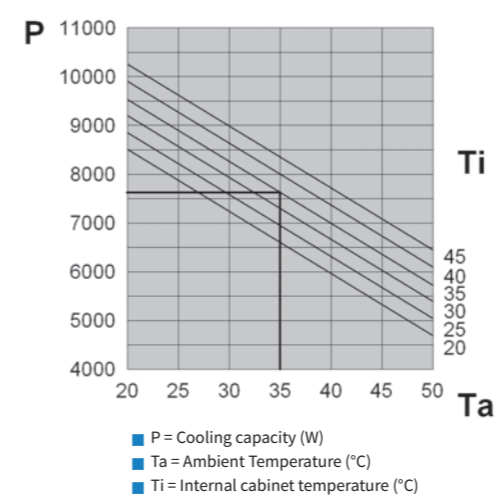

Dimensions

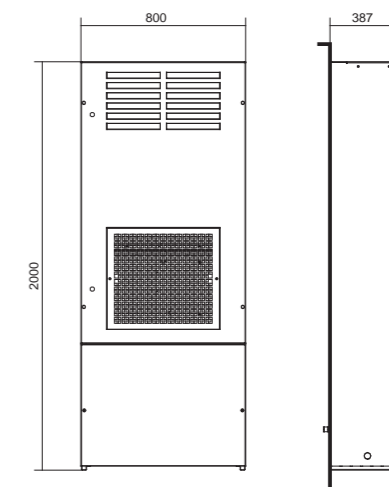

EMOA0

Wall-mount air conditioners for outdoor applications

COOLING CAPACITY

9400 - 9850 W



Features	UoM	EMOA0MMEB	EMOA0NMEB
Cooling capacity EN14511 - A35A35	W	9400	9850
Cooling capacity EN14511 - A35A50	W	7000	7350
Power supply	V ~ Hz	400 3~ 50	460 3~ 60
Width	mm	800	800
Height	mm	2000	2000
Depth	mm	387	387
Max current	A	9.1	10.3
Inrush current	A	30.7	32.5
T Fuse	A	18	18
Power draw EN14511 - A35A35	W	3650	4380
Power draw EN14511 - A35A50	W	5400	6340
Operating cycle	-	100%	100%
Electrical connection	-	Cable L = 3 m	Cable L = 3 m
R134a Refrigerant	kg	2.3	2.3
Max refrigeration circuit pressure	bar	27	27
External air fan capacity	m ³ /h	2900	2900
Cabinet air fan capacity	m ³ /h	2900	2900
Internal temperature range	°C	+20 - +46	+20 - +46
Temperature regulation	-	Electromechanical thermostat, factory set to 35°C	
External temperature range	°C	-20 - +50	-20 - +50
EN60529 ingress protection - cabinet side	-	IP54	IP54
EN60529 ingress protection - ambient side	-	IP34*	IP34*
Noise level	dB (A)	77	77
Weight	kg	180	180
Colour	-	RAL 7035 embossed effect	
Conformity	-	CE	CE

Accessories	
Pack of 5 fabric air filters	C15000188
Pack of 1 metal air filter	C15000189
External stainless-steel framework	
Coating in non-standard colour	
48VDC evaporator fan	
Anti-tamper screw kit	
High temperature alarm	
Pressure alarms (low, high)	

* IP54 rated exterior electrical connections

Performance (EMOA0MMEB)

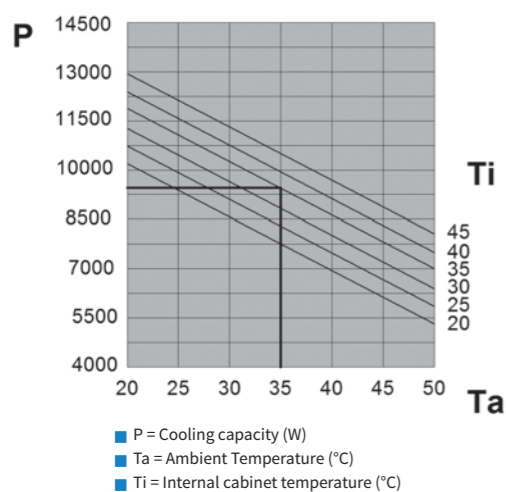

Dimensions

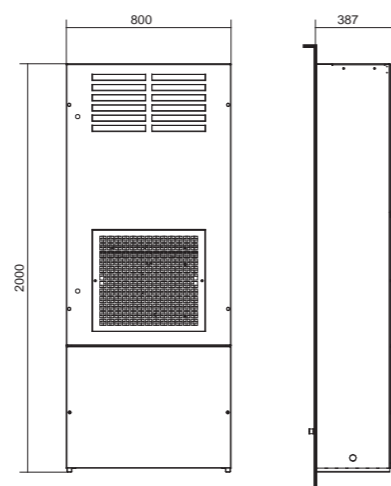

BLU-BIT

Air-water heat exchangers for door or wall and roof installation

High cooling power capacities with reduced unit sizes, completely free from scheduled maintenance. These are the main features of the BLU-BIT range, the best choice of air conditioner when working in extreme temperature environments with dust and oil contamination.



BLU-BIT

Air-water heat exchangers for door or wall and roof installation

WIDE RANGE OF POWER OUTPUTS

The range of cooling power outputs ranges from 1000 to 25000 W for the vertical range, while the roof range is represented by a 2500 W model.

NO SCHEDULED MAINTENANCE

The special layout of these machines means they do not require regular/scheduled maintenance (replacement of filters or cleaning of the heat exchanger) to guarantee full operation.

OPTIMISED PROTECTION OF THE CABINET

BLU/BIT heat exchangers, thanks to their innovative design combined with the correct application of the self-adhesive sealing gasket, guarantees IP55 ingress protection (EN 60529), meaning they are ideal for particularly contaminated outdoor environments.

ENVIRONMENTAL PROTECTION

BLU/BIT heat exchangers use water as the heat transfer medium. As this is a natural product, the environmental impact is guaranteed to be permanently low. Moreover, these machines are extremely quiet, contributing to help keep the noise level of the environments where they are installed low.

SUPPLY VOLTAGES

The supply voltages for cooling capacities up to 4500 W are 230V single phase and 115V single phase, both in 50-60Hz dual frequency. For higher power models, the available voltages are 230V single phase and 400/440V dual phase, both in 50-60Hz dual frequency.

PAINT/COATING

The standard colour is RAL 7035 textured. The coating is epoxy powder coating. On request, non-standard colours are also available. Stainless-steel versions are also available on request.

ACCESSORIES

In order to optimise the heat exchange on the basis of the temperature required inside the enclosure, avoid using water unnecessarily and allow correct condensate management, thermostats and/or level indicators can be incorporated to control an ON/OFF solenoid valve which will allow or inhibit the water flow.

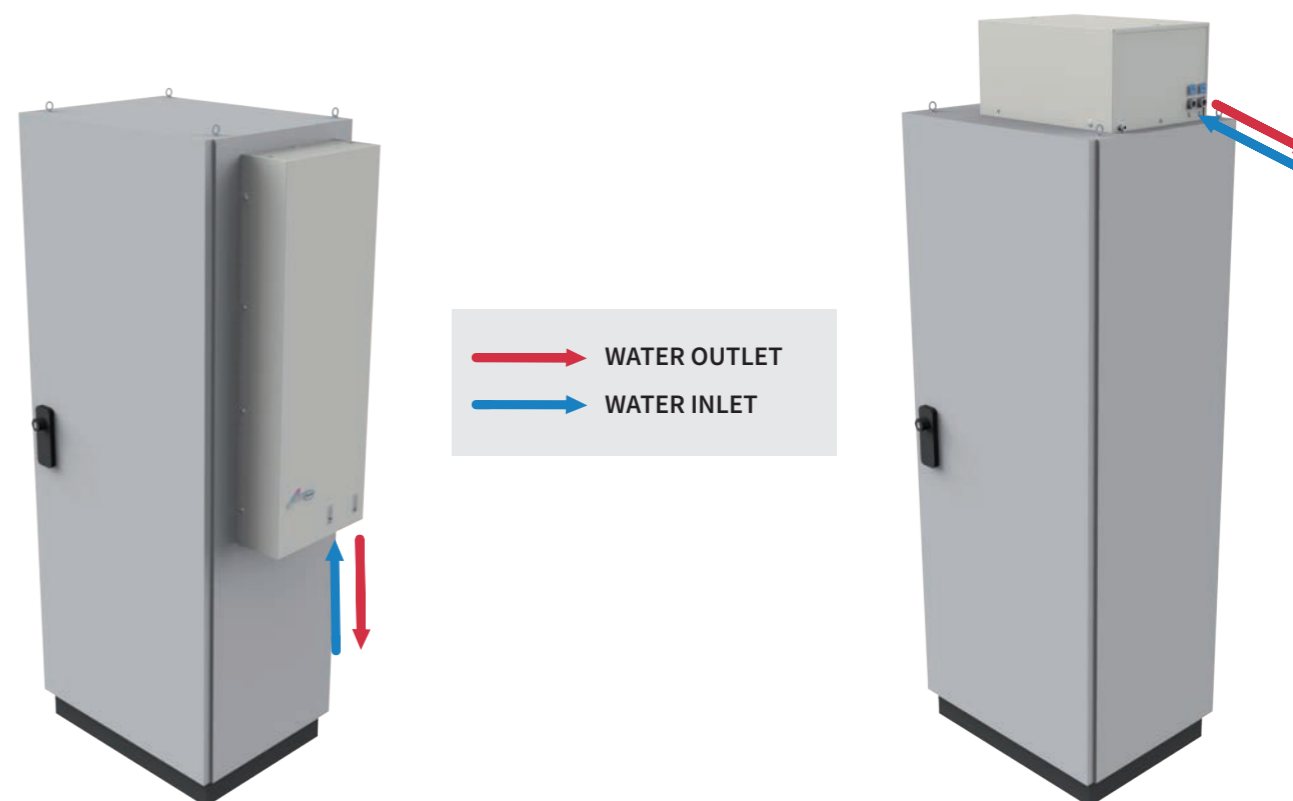

Application tips

- These machines allow the relationship between cooling power and volume to be maximised.
- The air-water heat exchangers are ideal for particularly dirty environments thanks to their IP rating.
- In order to allow correct operation, it must be possible to connect to an existing water supply or else it must be possible to connect these machines to water chillers.
- BLU/BIT heat exchangers allow cooling of the cabinet interior to below the ambient temperature, which can be up to 70°C.
- When choosing the heat exchanger, keep a 10% margin over and above the most demanding operating conditions foreseen.
- Seal the cabinet well. The presence of any cracks would lead to excessive condensate production and would lower the protective effect of the heat exchanger when operating in particularly dirty environments.
- Always install the heat exchanger in the highest possible position of the cabinet in order to allow the air intake to draw in air of the highest possible temperature, optimising the heat exchange.
- When arranging the electrical/electronic layout, try to avoid blocking the air flow in order to prevent compromising the heat exchange.
- The heat exchanger power supply line must be protected with a time delay fuse or circuit breaker of suitable size on the basis of the unit's technical data.

BIT25

Air-water heat exchangers for roof installation

COOLING CAPACITY

2500 W



Features	UoM	BIT25BX0B	BIT25CX0B
Cooling capacity - W10A35	W	2500	2500
Water flow rate	l/h	500	500
Power supply	V ~ Hz	230 1~ 50-60	115 1~ 50-60
Width	mm	400	400
Height	mm	270	270
Depth	mm	540	540
Max current	A	0.30	0.62
T Fuse	A	2	2
Power draw - W10A35	W	65	67
Operating cycle	-	100%	100%
Electrical connection	-	Cable L = 3 m	Cable L = 3 m
Type of Refrigerant	-	Water	Water
Max refrigeration circuit pressure	bar	10	10
Water connection	-	1/2"G	1/2"G
Air flow rate	m ³ /h	750	750
Internal temperature range	°C	20-60	20-60
External temperature range	°C	1-70	1-70
IP rating EN60529	-	IP55	IP55
Noise level	dB (A)	58	58
Weight	kg	19	19
Colour	-	RAL 7035 embossed effect	
Conformity	-	CE	CE

Accessories	
Thermostat 20-46°C, gas bulb 15A	C16000002
Solenoid valve, NC	C15000119
Level indicator, NO	C16000140
External stainless-steel framework	
Coating in non-standard colour	

Performance

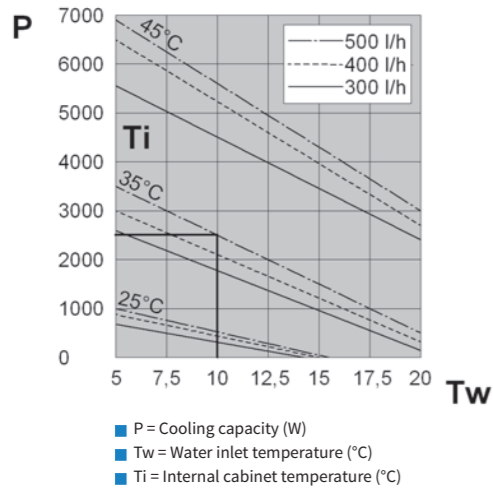

Dimensions

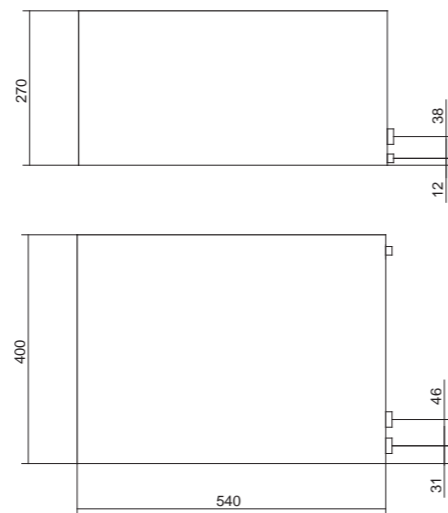

BLU10

Air-water heat exchangers for door or wall installation

COOLING CAPACITY

1000 W

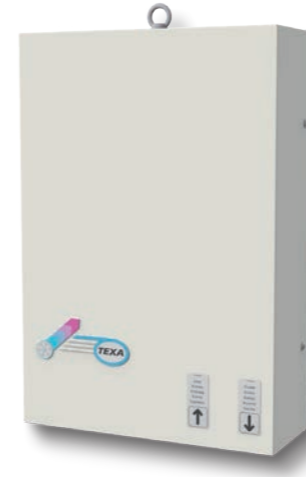

Features	UoM	BLU10BX0B	BLU10BXUB	BLU10CX0B
Cooling capacity - W10A35	W	1000	1000	1000
Water flow rate	l/h	150	150	150
Power supply	V ~ Hz	230 1~ 50-60	230 1~ 50-60	115 1~ 50-60
Width	mm	311	311	311
Height	mm	453	453	453
Depth	mm	115	115	115
Max current	A	0.17	0.20	0.38
T Fuse	A	2	2	2
Power draw - W10A35	W	29	34	25
Operating cycle	-	100%	100%	100%
Electrical connection	-	Cable L = 3 m	Cable L = 3 m	Cable L = 3 m
Type of Refrigerant	-	Water	Water	Water
Max refrigeration circuit pressure	bar	10	10	10
Water connection	-	3/8"G	3/8"G	3/8"G
Air flow rate	m ³ /h	330	330	330
Internal temperature range	°C	20-60	20-60	20-60
External temperature range	°C	1-70	1-60	1-70
IP rating EN60529	-	IP55	IP55	IP55
Noise level	dB (A)	55	55	55
Weight	kg	12	12	12
Colour	-	RAL 7035 embossed effect		
Conformity	-	CE	CE cULus	CE

Accessories	
Thermostat 20-46°C, gas bulb 15A	C16000002
Solenoid valve, NC	C15000777
Level indicator, NO	C16000140
External stainless-steel framework	
Coating in non-standard colour	

Performance

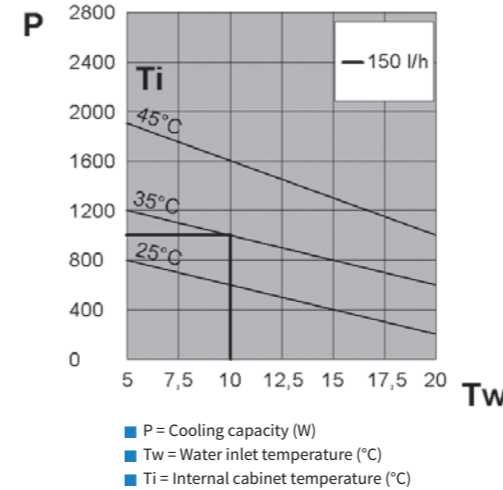

Dimensions

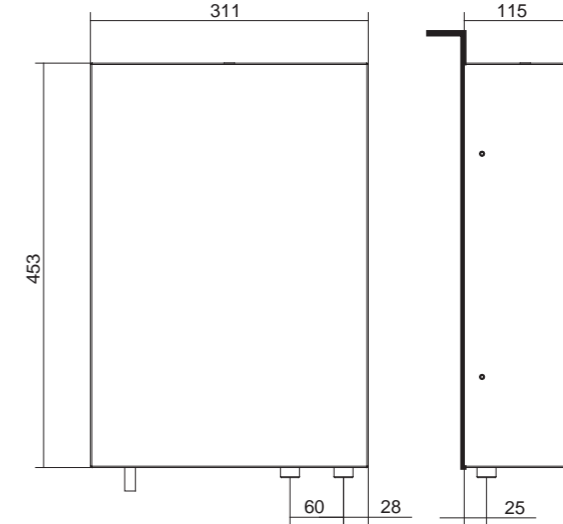

BLU18

Air-water heat exchangers for door or wall installation

COOLING CAPACITY

1750 W



Features	UoM	BLU18BX0B	BLU18BXUB	BLU18CX0B
Cooling capacity - W10A35	W	1750	1750	1750
Water flow rate	l/h	150	150	150
Power supply	V ~ Hz	230 1~ 50-60	230 1~ 50-60	115 1~ 50-60
Width	mm	398	398	398
Height	mm	901	901	901
Depth	mm	137	137	137
Max current	A	0.36	0.30	0.76
T Fuse	A	2	2	2
Power draw - W10A35	W	75	60	77
Operating cycle	-	100%	100%	100%
Electrical connection	-	Cable L = 3 m	Cable L = 3 m	Cable L = 3 m
Type of Refrigerant	-	Water	Water	Water
Max water circuit pressure	bar	10	10	10
Water connection	-	1/2"G	1/2"G	1/2"G
Air flow rate	m ³ /h	570	570	570
Internal temperature range	°C	20-60	20-60	20-60
External temperature range	°C	1-70	1-60	1-70
IP rating EN60529	-	IP55	IP55	IP55
Noise level	dB (A)	58	58	58
Weight	kg	18	18	18
Colour	-	RAL 7035 embossed effect		
Conformity	-	CE	CE c _{RU} us	CE

Accessories

Thermostat 20-46°C, gas bulb 15A	C16000002
Solenoid valve, NC	C15000119
Level indicator, NO	C16000140
External stainless-steel framework	
Coating in non-standard colour	

Performance

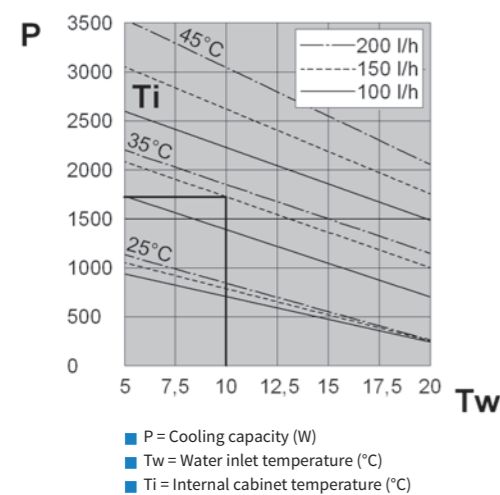

- P = Cooling capacity (W)
- Tw = Water inlet temperature (°C)
- Ti = Internal cabinet temperature (°C)

Dimensions

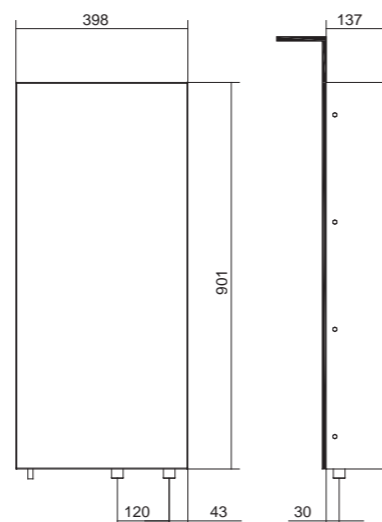

BLU25

Air-water heat exchangers for door or wall installation

COOLING CAPACITY

2500 W



Features	UoM	BLU25BX0B	BLU25BXUB	BLU25CX0B
Cooling capacity - W10A35	W	2500	2500	2500
Water flow rate	l/h	500	500	500
Power supply	V ~ Hz	230 1~ 50-60	230 1~ 50-60	115 1~ 50-60
Width	mm	398	398	398
Height	mm	901	901	901
Depth	mm	137	137	137
Max current	A	0.33	0.60	0.74
T Fuse	A	2	2	2
Power draw - W10A35	W	80	100	82
Operating cycle	-	100%	100%	100%
Electrical connection	-	Cable L = 3 m	Cable L = 3 m	Cable L = 3 m
Type of Refrigerant	-	Water	Water	Water
Max refrigeration circuit pressure	bar	10	10	10
Water connection	-	1/2"G	1/2"G	1/2"G
Air flow rate	m ³ /h	860	860	860
Internal temperature range	°C	20-60	20-60	20-60
External temperature range	°C	1-70	1-60	1-70
IP rating EN60529	-	IP55	IP55	IP55
Noise level	dB (A)	58	58	58
Weight	kg	19	19	19
Colour	-	RAL 7035 embossed effect		
Conformity	-	CE	CE c _{RU} us	CE

Accessories

Thermostat 20-46°C, gas bulb 15A	C16000002
Solenoid valve, NC	C15000119
Level indicator, NO	C16000140
External stainless-steel framework	
Coating in non-standard colour	

Performance

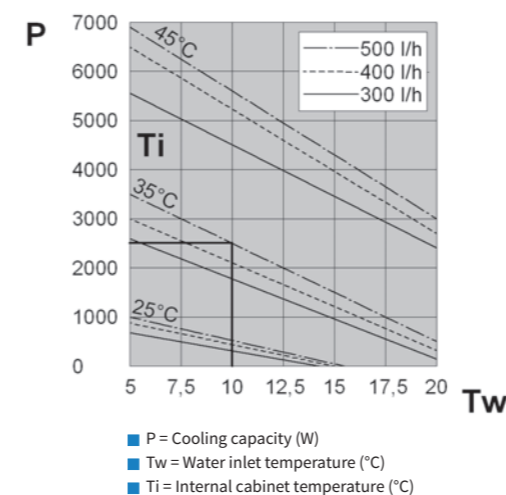

- P = Cooling capacity (W)
- Tw = Water inlet temperature (°C)
- Ti = Internal cabinet temperature (°C)

Dimensions

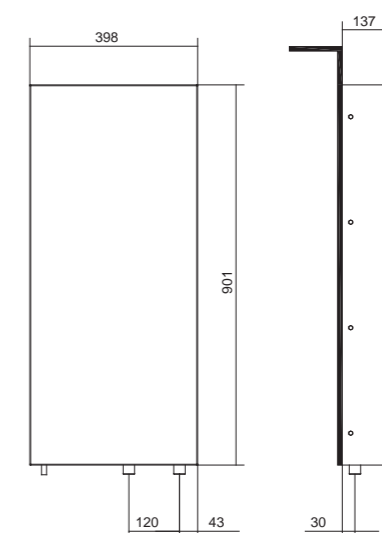

BLU35

Air-water heat exchangers for door or wall installation

COOLING CAPACITY

3500 W



Features	UoM	BLU35BX0B	BLU35BXUB	BLU35CX0B
Cooling capacity - W10A35	W	3500	3500	3500
Water flow rate	l/h	500	500	500
Power supply	V - Hz	230 1~ 50-60	230 1~ 50-60	115 1~ 50-60
Width	mm	398	398	398
Height	mm	1148	1148	1148
Depth	mm	163	163	163
Max current	A	0.55	0.80	1.12
T Fuse	A	2	2	2
Power draw - W10A35	W	130	140	135
Operating cycle	-	100%	100%	100%
Electrical connection	-	Cable L = 3 m	Cable L = 3 m	Cable L = 3 m
Type of Refrigerant	-	Water	Water	Water
Max liquid circuit pressure	bar	10	10	10
Water connection	-	1/2"G	1/2"G	1/2"G
Air flow rate	m ³ /h	1050	1050	1050
Internal temperature range	°C	20-60	20-60	20-60
External temperature range	°C	1-70	1-60	1-70
IP rating EN60529	-	IP55	IP55	IP55
Noise level	dB (A)	64	64	64
Weight	kg	29	29	29
Colour	-	RAL 7035 embossed effect		
Conformity	-	CE	CE cULus	CE

Accessories	
Thermostat 20-46°C, gas bulb 15A	C16000002
Solenoid valve, NC	C15000119
Level indicator, NO	C16000140
External stainless-steel framework	
Coating in non-standard colour	

BLU45

Air-water heat exchangers for door or wall installation

COOLING CAPACITY

4500 W



Features	UoM	BLU45BX0B	BLU45BXUB	BLU45CX0B
Cooling capacity - W10A35	W	4500	4500	4500
Water flow rate	l/h	500	500	500
Power supply	V - Hz	230 1~ 50-60	230 1~ 50-60	115 1~ 50-60
Width	mm	398	398	398
Height	mm	1148	1148	1148
Depth	mm	163	163	163
Max current	A	0.71	1.20	1.50
T Fuse	A	2	4	4
Power draw - W10A35	W	160	220	170
Operating cycle	-	100%	100%	100%
Electrical connection	-	Cable L = 3 m	Cable L = 3 m	Cable L = 3 m
Type of Refrigerant	-	Water	Water	Water
Max refrigeration circuit pressure	bar	10	10	10
Water connection	-	1/2"G	1/2"G	1/2"G
Air flow rate	m ³ /h	1450	1450	1450
Internal temperature range	°C	20-60	20-60	20-60
External temperature range	°C	1-70	1-60	1-70
IP rating EN60529	-	IP55	IP55	IP55
Noise level	dB (A)	69	69	69
Weight	kg	30	30	30
Colour	-	RAL 7035 embossed effect		
Conformity	-	CE	CE cULus	CE

Accessories	
Thermostat 20-46°C, gas bulb 15A	C16000002
Solenoid valve, NC	C15000119
Level indicator, NO	C16000140
External stainless-steel framework	
Coating in non-standard colour	

Performance

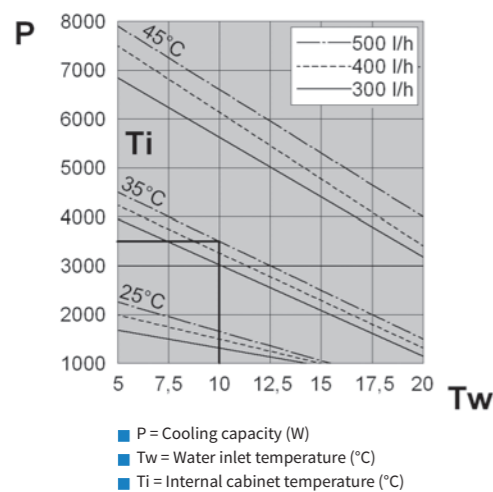

Dimensions

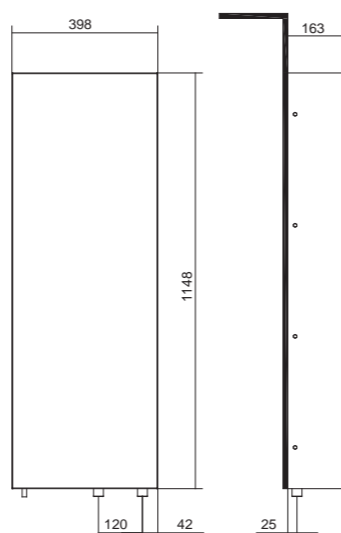

Performance

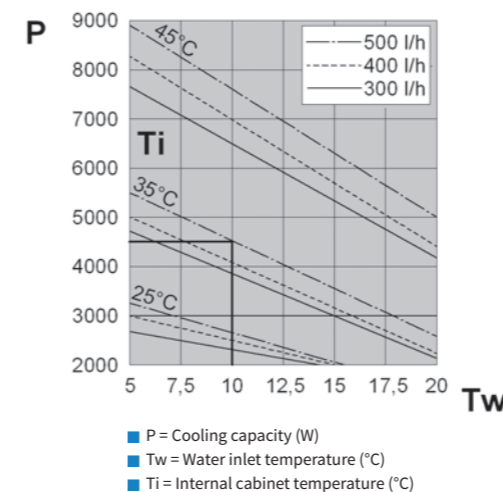

Dimensions

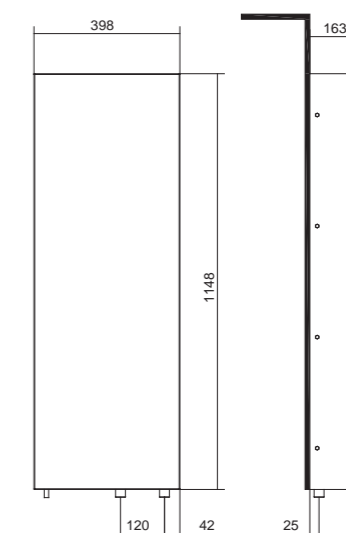

BLU60

Air-water heat exchangers for door or wall installation

COOLING CAPACITY

6000 W



Performance

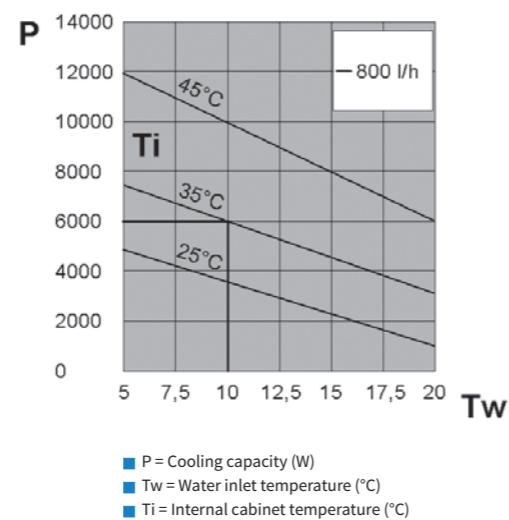

Dimensions

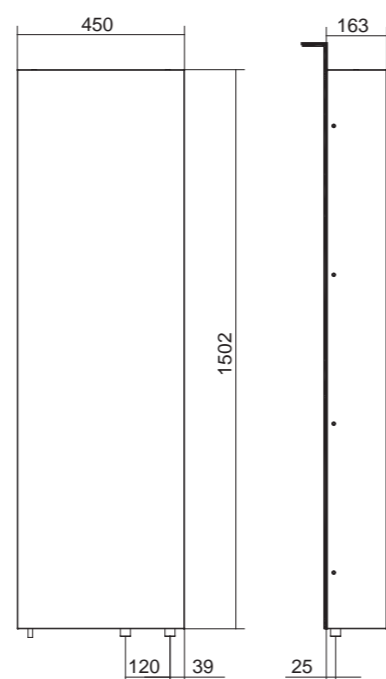

Features	UoM	BLU60BX0B	BLU60BXUB	BLU60CX0B	BLU60GX0B
Cooling capacity - W10A35	W	6000	6000	6000	6000
Water flow rate	l/h	800	800	800	800
Power supply	V - Hz	230 1~ 50-60	230 1~ 50-60	115 1~ 50-60	400/440 2~ 50-60
Width	mm	450	450	450	450
Height	mm	1502	1502	1502	1502
Depth	mm	163	163	163	163
Max current	A	0.71	1.20	1.50	0.40
T Fuse	A	2	4	4	1
Power draw - W10A35	W	160	220	170	170
Operating cycle	-	100%	100%	100%	100%
Electrical connection		Cable L = 3 m	Cable L = 3 m	Cable L = 3 m	Cable L = 3 m
Type of Refrigerant	-	Water	Water	Water	Water
Max liquid circuit pressure	bar	10	10	10	10
Water connection	m ³ /h	1/2"G	1/2"G	1/2"G	1/2"G
Air flow rate	-	1450	1450	1450	1450
Internal temperature range	°C	20-60	20-60	20-60	20-60
External temperature range	°C	1-70	1-60	1-70	1-70
EN60529 ingress protection - cabinet side	-	IP55	IP55	IP55	IP55
Noise level	dB (A)	69	69	69	69
Weight	kg	40	40	40	42
Colour	-	RAL 7035 embossed effect			
Conformity	-	CE	CE	CE	CE

Accessories	
Thermostat 20-46°C, gas bulb 15A	C16000002
Solenoid valve, NC	C15000119
Level indicator, NO	C16000140
External stainless-steel framework	
Coating in non-standard colour	

BLUA0

Air-water heat exchangers for door or wall installation

COOLING CAPACITY

10000 W



Features	UoM	BLUA0BX0B	BLUA0GX0B
Cooling capacity - W10A35	W	10000	10000
Water flow rate	l/h	2000	2000
Power supply	V ~ Hz	230 1~ 50-60	400/440 2~ 50-60
Width	mm	797	797
Height	mm	1935	1935
Depth	mm	206	206
Max current	A	1.90	1.10
T Fuse	A	4	2
Power draw - W10A35	W	420	440
Operating cycle	-	100%	100%
Electrical connection	-	Cable L = 3 m	Cable L = 3 m
Type of Refrigerant	-	Water	Water
Max liquid circuit pressure	bar	10	10
Water connection	-	3/4"G	3/4"G
Air flow rate	m ³ /h	2900	2900
Internal temperature range	°C	20-60	20-60
External temperature range	°C	1-70	1-70
IP rating EN60529	-	IP55	IP55
Noise level	dB (A)	70	70
Weight	kg	90	90
Colour	-	RAL 7035 embossed effect	
Conformity	-	CE	CE

Accessories

Thermostat 20-46°C, gas bulb 15A	C16000002
Solenoid valve, NC	C15000120
Level indicator, NO	C16000140
External stainless-steel framework	
Coating in non-standard colour	

Performance

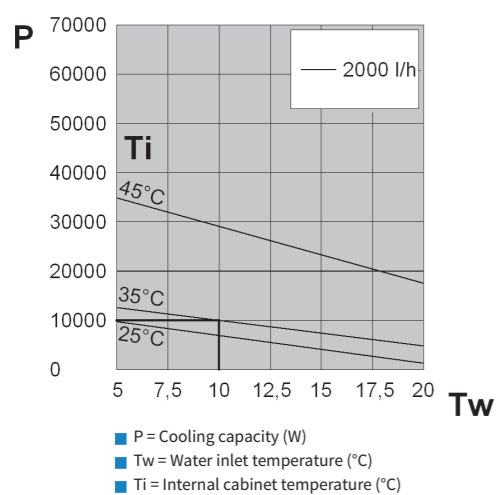

Dimensions

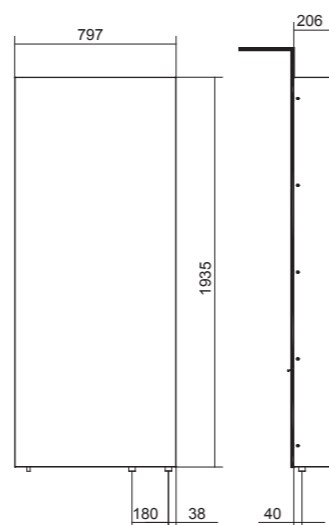

BLUA5

Air-water heat exchangers for door or wall installation

COOLING CAPACITY

15000 W



Features	UoM	BLUA5BX0B	BLUA5GX0B
Cooling capacity - W10A35	W	15000	15000
Water capacity	l/h	2000	2000
Power supply	V ~ Hz	230 1~ 50-60	400/440 2~ 50-60
Width	mm	797	797
Height	mm	1935	1935
Depth	mm	206	206
Max current	A	1.90	1.10
T Fuse	A	4	2
Power draw - W10A35	W	420	440
Operating cycle	-	100%	100%
Electrical connection	-	Cable L = 3 m	Cable L = 3 m
Type of Refrigerant	-	Water	Water
Max liquid circuit pressure	bar	10	10
Water connection	-	3/4"G	3/4"G
Air flow rate	m ³ /h	2900	2900
Internal temperature range	°C	20-60	20-60
External temperature range	°C	1-70	1-70
IP rating EN60529	-	IP55	IP55
Noise level	dB (A)	72	70
Weight	kg	92	92
Colour	-	RAL 7035 embossed effect	
Conformity	-	CE	CE

Accessories

Thermostat 20-46°C, gas bulb 15A	C16000002
Solenoid valve, NC	C15000120
Level indicator, NO	C16000140
External stainless-steel framework	
Coating in non-standard colour	

Performance

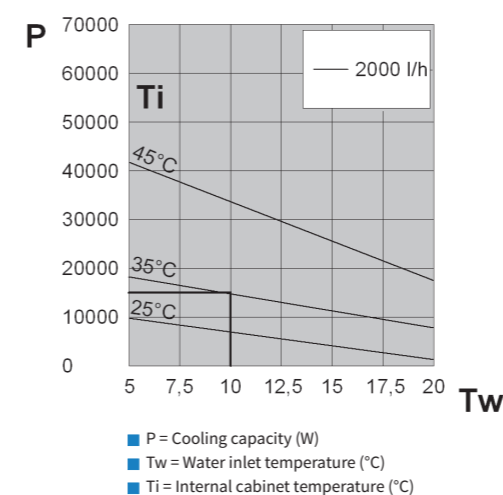

Dimensions

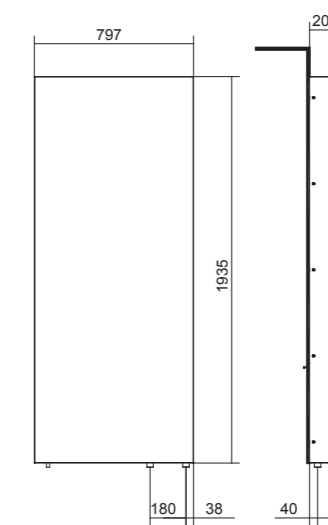

BLUB5

Air-water heat exchangers for door or wall installation

COOLING CAPACITY

25000 W



Features	UoM	BLUB5BX0B	BLUB5KX0B
Cooling capacity - W10A35	W	25000	25000
Water flow rate	l/h	2000	2000
Power supply	V ~ Hz	230 1~ 50-60	400/460 2~ 50-60
Width	mm	797	797
Height	mm	1935	1935
Depth	mm	350	350
Max current	A	2.20	1.30
T Fuse	A	4	2
Power draw - W10A35	W	500	530
Operating cycle	-	100%	100%
Electrical connection	-	Cable L = 3 m	Cable L = 3 m
Type of Refrigerant	-	Water	Water
Max liquid circuit pressure	bar	10	10
Water connection	-	3/4"G	3/4"G
Air flow rate	m ³ /h	5200	5200
Internal temperature range	°C	20-60	20-60
External temperature range	°C	1-70	1-70
IP rating EN60529	-	IP55	IP55
Noise level	dB (A)	75	75
Weight	kg	120	120
Colour	-	RAL 7035 embossed effect	
Conformity	-	CE	CE

Accessories

Thermostat 20-46°C, gas bulb 15A	C16000002
Solenoid valve, NC	C15000120
Level indicator, NO	C16000140
External stainless-steel framework	
Coating in non-standard colour	

Performance

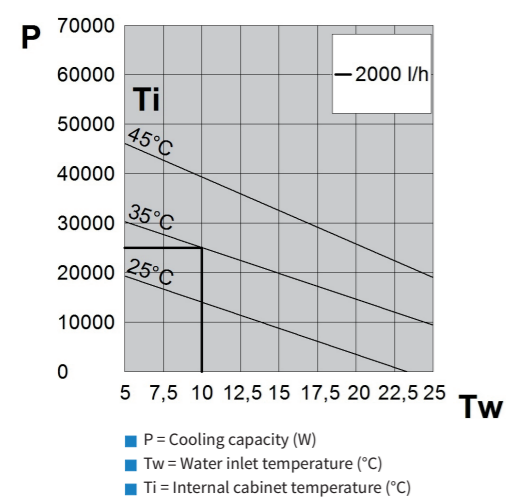

Dimensions

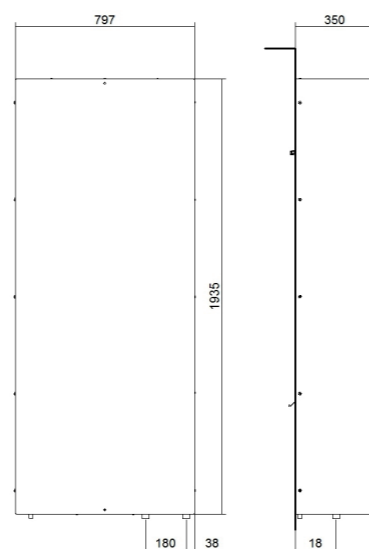

MIX

Air-air heat exchangers

High heat exchange efficiency and compact size. The MIX range is the most cost-effective solution for cooling cabinets in favourable ambient conditions.



MIX

Air-air heat exchangers

WIDE RANGE OF SPECIFIC POWER OUTPUTS

The specific thermal power outputs range from 22 to 80 W/K, covering most requirements for these products.

FLEXIBILITY AND SPEED OF INSTALLATION

All heat exchangers in the MIX range can be installed both inside and outside the cabinet as both a rear exit and a side exit for electrical connections is provided for. The simple drilling to be performed on the panel allows for a quick installation with the supplied accessory kit.

FAST, REDUCED MAINTENANCE

MIX heat exchangers are equipped with heat exchange coils which prevent clogging by solid contaminants present in the air and which maintain high thermal exchange efficiency even in demanding environmental conditions, minimising maintenance requirements. The remaining maintenance required has been designed to allow easy removal both of the fans and the heat exchanger coil to ensure quick and safe operations.

MAXIMUM HEAT REMOVAL

Air intake from the upper part of the cabinet, countercurrent flows and high-efficiency heat exchanger surfaces determine the most rational implementation for these products which result in the removal of the maximum amount of heat.

OPTIMISED PROTECTION OF THE CABINET

The monobloc implementation of the heat exchanger surfaces and the application of suitable seals ensures that the cabinet retains IP54 ingress protection.

RATIONAL DESIGN

All MIX heat exchangers are designed to minimise operating costs by optimising the heat exchange. Overload protection is also guaranteed by appropriate devices.

SUPPLY VOLTAGES

All versions are available with 230V single phase or 115V single phase power supply as standard, both in 50-60 Hz dual frequency. DC versions or two-phase AC versions are available on request.

PAINT/COATING

The standard colour is RAL 7035 textured. The coating is epoxy powder coating. Non-standard colours and stainless-steel versions are available on request.

Air-air heat exchanger selection diagram

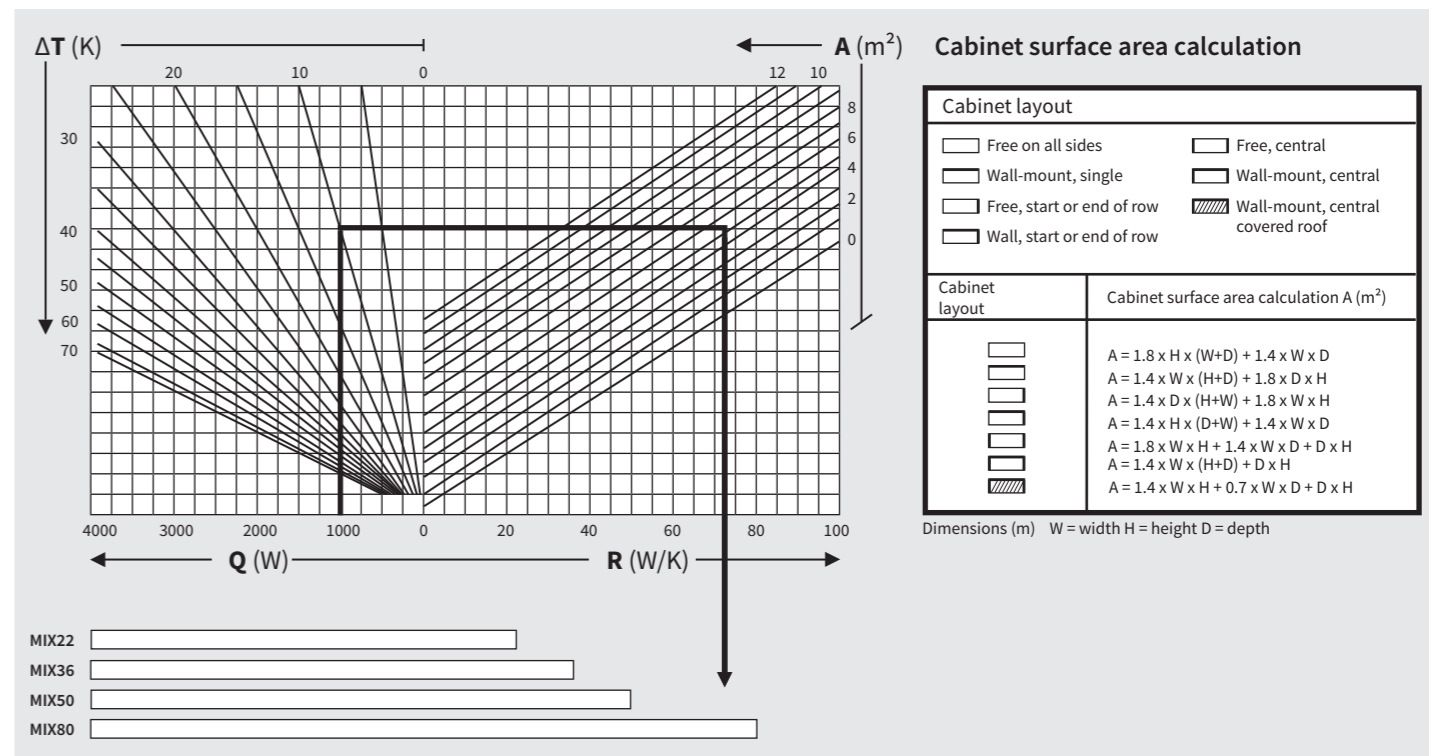

Q = Heat output to dissipate
R = Specific cooling power
ΔT = Temperature differential
A = Cabinet surface area

Example:
Dissipated power 1000 W
Temperature differential 10 K
Cabinet surface area 5 m² } Unit chosen **MIX80**



Application tips

- If the outside air temperatures are much lower than the internal temperature required for the cabinet, air-air heat exchangers from the MIX range are advisable, particularly if the air outside the cabinet contains contaminants such as emulsions, powders or chemical substances which must not enter the cabinet under any circumstances.
- Always try to facilitate the air flow inside the electrical cabinet when designing the layout of the components by preventing any obstructions in the air inlet-outlet areas. Moreover, components with internal ventilation of their own must have their air flow arranged so as to not impede the air flow of the air conditioner.
- When choosing a heat exchanger, keep a margin of safety of at least 10%, taking the most demanding conditions of operation into account.
- The standard version of the heat exchanger has no equipment for controlling the interior cabinet temperature: if your equipment must work within a specific temperature range, or you simply wish to save energy, choose the version with adjustable thermostat.
- Seal the cabinet thoroughly as any cracks or other openings would reduce the level of protection offered by the heat exchanger.
- Install the heat exchanger on the door or the wall, but always in the highest possible position in order to ensure that air is taken in from the top part of the cabinet, where a high temperature area is created. This solution is essential to obtain the maximum performance from the heat exchanger.

MIX22

Air-air heat exchangers

SPECIFIC COOLING POWER

22 W/K



Features	UoM	MIX22BX0B	MIX22CX0B
Specific cooling power	W/K	22	22
Power supply	V ~ Hz	230 1~ 50-60	115 1~ 50-60
Width	mm	189	189
Height	mm	413	413
Depth	mm	149	149
Max current	A	0.5	0.96
T Fuse	A	1	2
Power draw	W	72	80
Operating cycle	-	100%	100%
Electrical connection	-	Cable L = 3 m	Cable L = 3 m
External air fan capacity	m ³ /h	280	280
Cabinet air fan capacity	m ³ /h	280	280
Temperature limits	°C	-5+55	-5+55
EN60529 ingress protection - cabinet side	-	IP54	IP54
Noise level	dB (A)	59	60
Weight	kg	7	7
Colour	-	RAL 7035 embossed effect	
Conformity	-	CE	CE

Accessories

Thermostat 0-60°C, normally open, 10A	AAFTO12
Thermostat 5-60°C, change-over contact, 10A	AAWTS10
External stainless-steel framework	
Coating in non-standard colour	

Performance

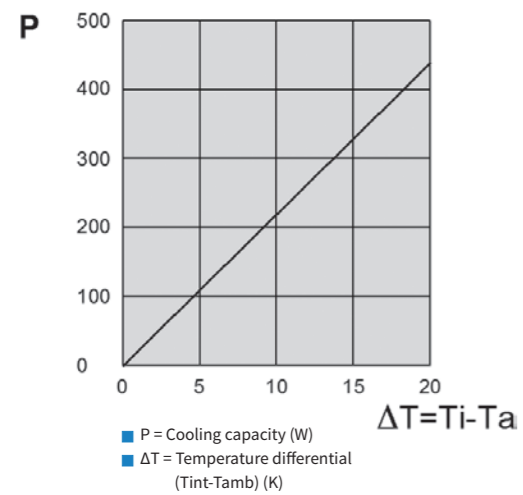

Dimensions

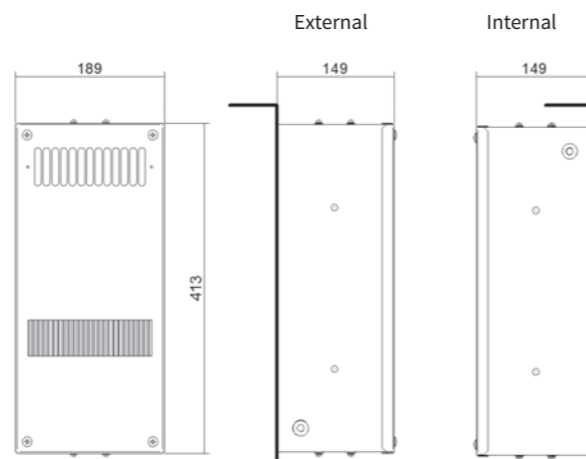

MIX36

Air-air heat exchangers

SPECIFIC COOLING POWER

36 W/K



Features	UoM	MIX36BX0B	MIX36CX0B
Specific cooling power	W/K	36	36
Power supply	V ~ Hz	230 1~ 50-60	115 1~ 50-60
Width	mm	316	316
Height	mm	771	771
Depth	mm	103	103
Max current	A	0.64	1.12
T Fuse	A	1	2
Power draw	W	140	150
Operating cycle	-	100%	100%
Electrical connection	-	Cable L = 3 m	Cable L = 3 m
External air fan capacity	m ³ /h	570	570
Cabinet air fan capacity	m ³ /h	570	570
Temperature limits	°C	-5+55	-5+55
EN60529 ingress protection - cabinet side	-	IP54	IP54
Noise level	dB (A)	67	67
Weight	kg	10	10
Colour	-	RAL 7035 embossed effect	
Conformity	-	CE	CE

Accessories

Thermostat 0-60°C, normally open, 10A	AAFTO12
Thermostat 5-60°C, change-over contact, 10A	AAWTS10
External stainless-steel framework	
Coating in non-standard colour	

Performance

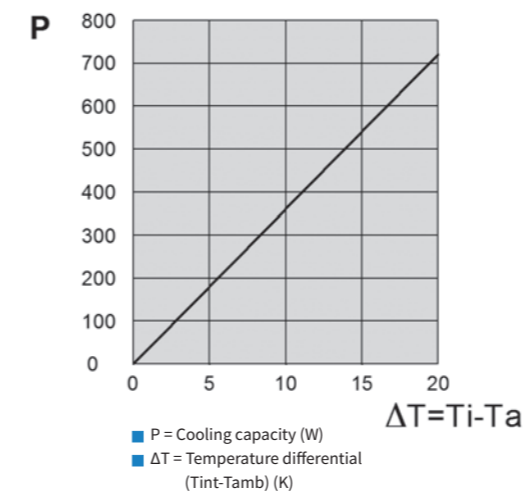

Dimensions

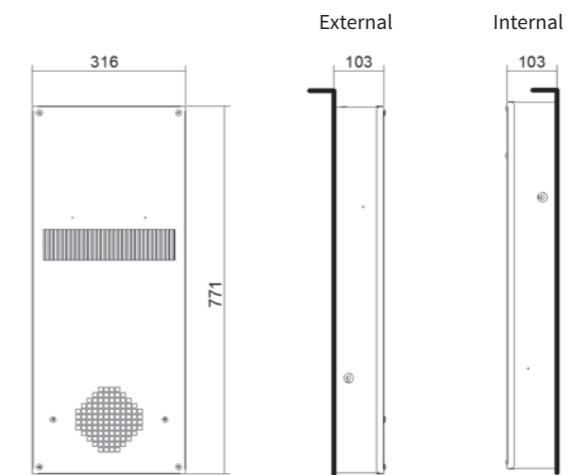

MIX50

Air-air heat exchangers

SPECIFIC COOLING POWER

50 W/K



Features	UoM	MIX50BX0B	MIX50CX0B
Specific cooling power	W/K	50	50
Power supply	V ~ Hz	230 1~ 50-60	115 1~ 50-60
Width	mm	316	316
Height	mm	771	771
Depth	mm	103	103
Max current	A	0.64	1.12
T Fuse	A	1	2
Power draw	W	140	150
Operating cycle	-	100%	100%
Electrical connection	-	Cable L = 3 m	Cable L = 3 m
External air fan capacity	m ³ /h	600	600
Cabinet air fan capacity	m ³ /h	600	600
Temperature limits	°C	-5+55	-5+55
EN60529 ingress protection - cabinet side	-	IP54	IP54
Noise level	dB (A)	67	67
Weight	kg	10	10
Colour	-	RAL 7035 embossed effect	
Conformity	-	CE	CE

Accessories

Thermostat 0-60°C, normally open, 10A	AAFTO12
Thermostat 5-60°C, change-over contact, 10A	AAWTS10
External stainless-steel framework	
Coating in non-standard colour	

Performance

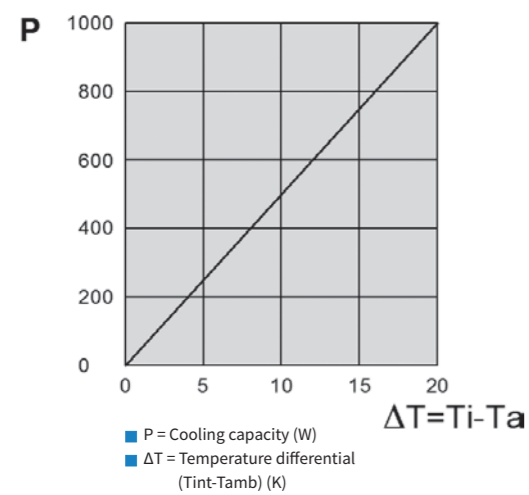

Dimensions

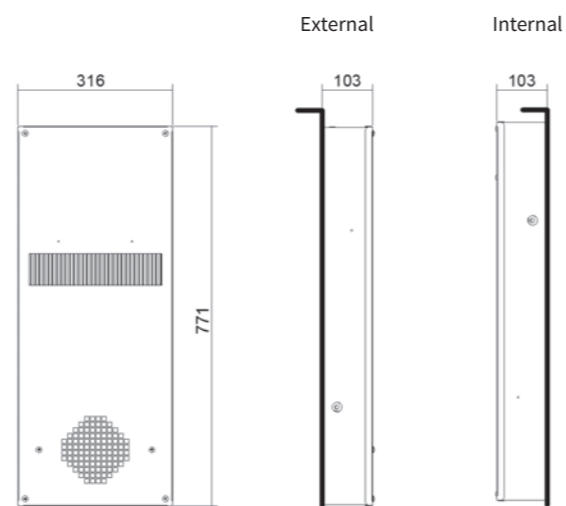

MIX80

Air-air heat exchangers

SPECIFIC COOLING POWER

80 W/K



Features	UoM	MIX80BX0B	MIX80CX0B
Specific cooling power	W/K	80	80
Power supply	V ~ Hz	230 1~ 50-60	115 1~ 50-60
Width	mm	317	317
Height	mm	1260	1260
Depth	mm	148	148
Max current	A	1.06	2.1
T Fuse	A	2	4
Power draw	W	240	255
Operating cycle	-	100%	100%
Electrical connection	-	Cable L = 3 m	Cable L = 3 m
External air fan capacity	m ³ /h	1050	1050
Cabinet air fan capacity	m ³ /h	1050	1050
Temperature limits	°C	-5+55	-5+55
EN60529 ingress protection - cabinet side	-	IP54	IP54
Noise level	dB (A)	75	75
Weight	kg	17	17
Colour	-	RAL 7035 embossed effect	
Conformity	-	CE	CE

Accessories

Thermostat 0-60°C, normally open, 10A	AAFTO12
Thermostat 5-60°C, change-over contact, 10A	AAWTS10
External stainless-steel framework	
Coating in non-standard colour	

Performance

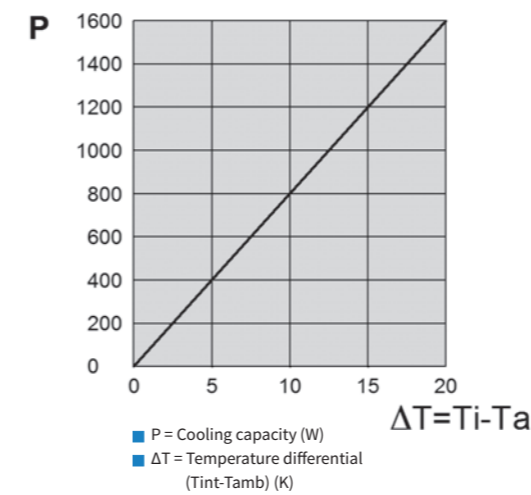

Dimensions

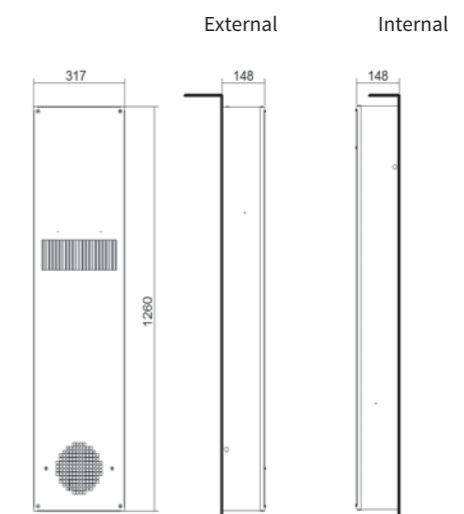

FAN

Ventilation units with filter

Quick installation and simple maintenance: the FAN range is **texa industries'** product range for electrical cabinet ventilation.

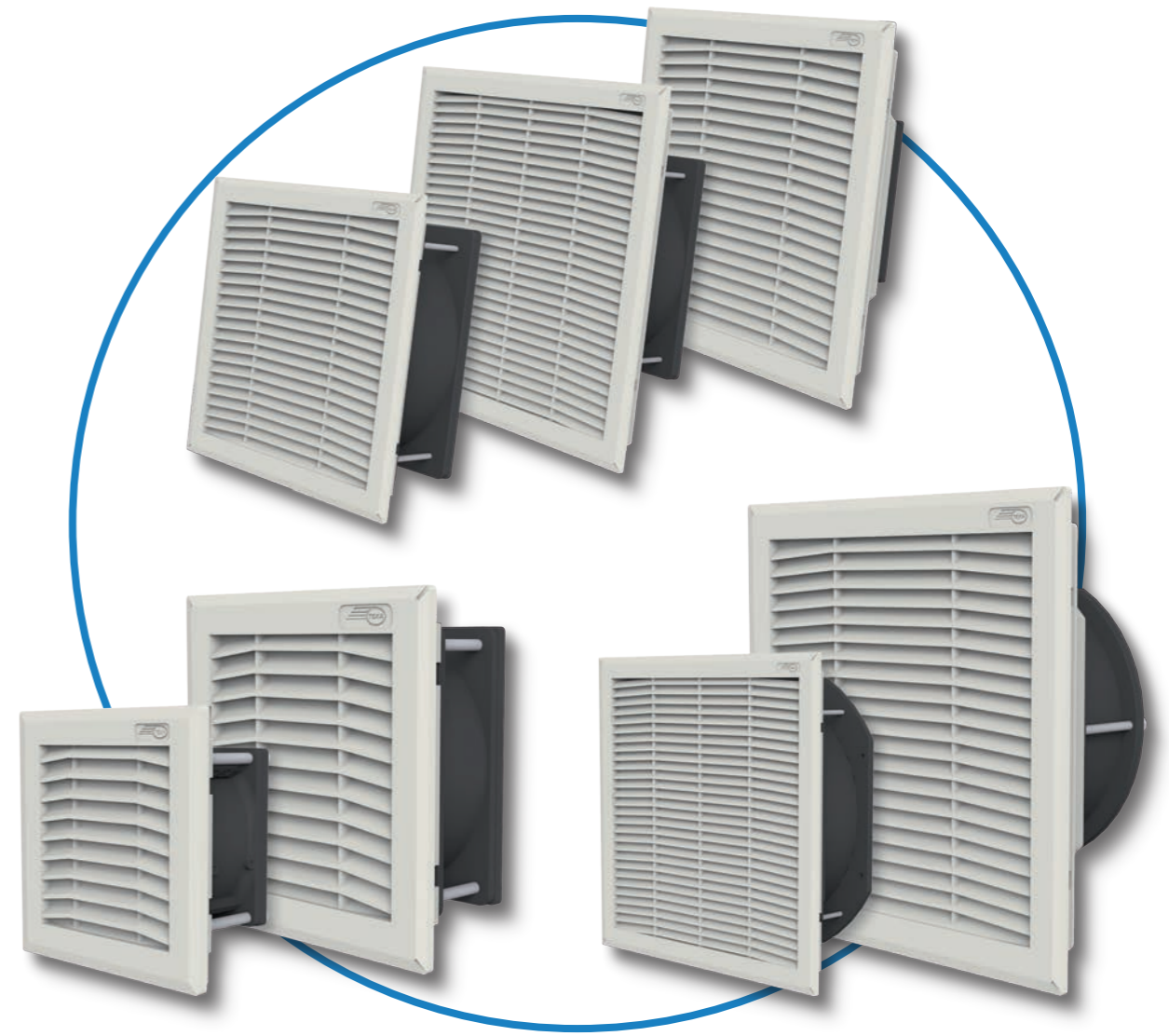

FAN

Ventilation units with filter

WIDE RANGE OF AIR FLOW RATES

Air flow rates range from 36 to 920 m³/h. The standard air flow direction is from the exterior to the interior of the cabinet for all ventilation units. The user can easily invert this by simply removing and reinstalling the fan in the reverse direction.

REDUCED EXTERNAL SIZE

The external projection is just 5 mm, in order to eliminate operational problems during transport and use of the cabinet due to excessive external dimensions.

REFINED DESIGN

As well as the attractive design of the grille, the minimal external protrusion ensures a positive aesthetic impact which supplements and improves the look of the cabinet. The grille and fan support system are made of extremely tough, self-extinguishing impact-resistant ABS, which meets UL94 V0 requirements. The standard colour is RAL 7035. On request, non-standard colours are possible for orders of sufficient quantities.

QUICK INSTALLATION

Installation is made simple and fast by making a square cut-out in the cabinet panel and by the snap fastening system which does not require fastening screws. The snap fastening system can be used on panels between 1.2 mm and 2.4 mm thick, which is virtually all. For thicknesses outside these limits, fastening can still be performed using the pack of screws included in all packs for this eventuality.

HIGH RELIABILITY

The fans used all feature motor shafts with bearings. High quality and with high volumetric efficiency, they have an expected lifetime of 30,000 hours at an ambient temperature of 55 °C. They all feature provision for making easy and safe electrical connections.

OPTIMISED PROTECTION OF THE CABINET

The special configuration of the watertight grille, the self-adhesive seal for coupling to the enclosure and the EU4 filter allow FAN units to achieve an IP54 rating. IP55 rated ingress protection can be achieved with optional accessories.

SUPPLY VOLTAGE

The FAN units are available for the most common supply voltages: 230V single phase, 115V single phase and 400V two phase, all 50-60Hz dual frequency; also available in 24V DC and 48V DC versions up to 230 m³/h. On request, versions for voltages not present in the catalogue can be produced for orders of sufficient quantities.

FILTER UNIT

FAN units can be used together with FIL filter meshes for expulsion of the air from the cabinet. Available in four sizes and created as the external part of the FAN unit, they allow the hot air to be expelled from the cabinet while maintaining its ingress protection rating.

Selection diagram for ventilation units with filter

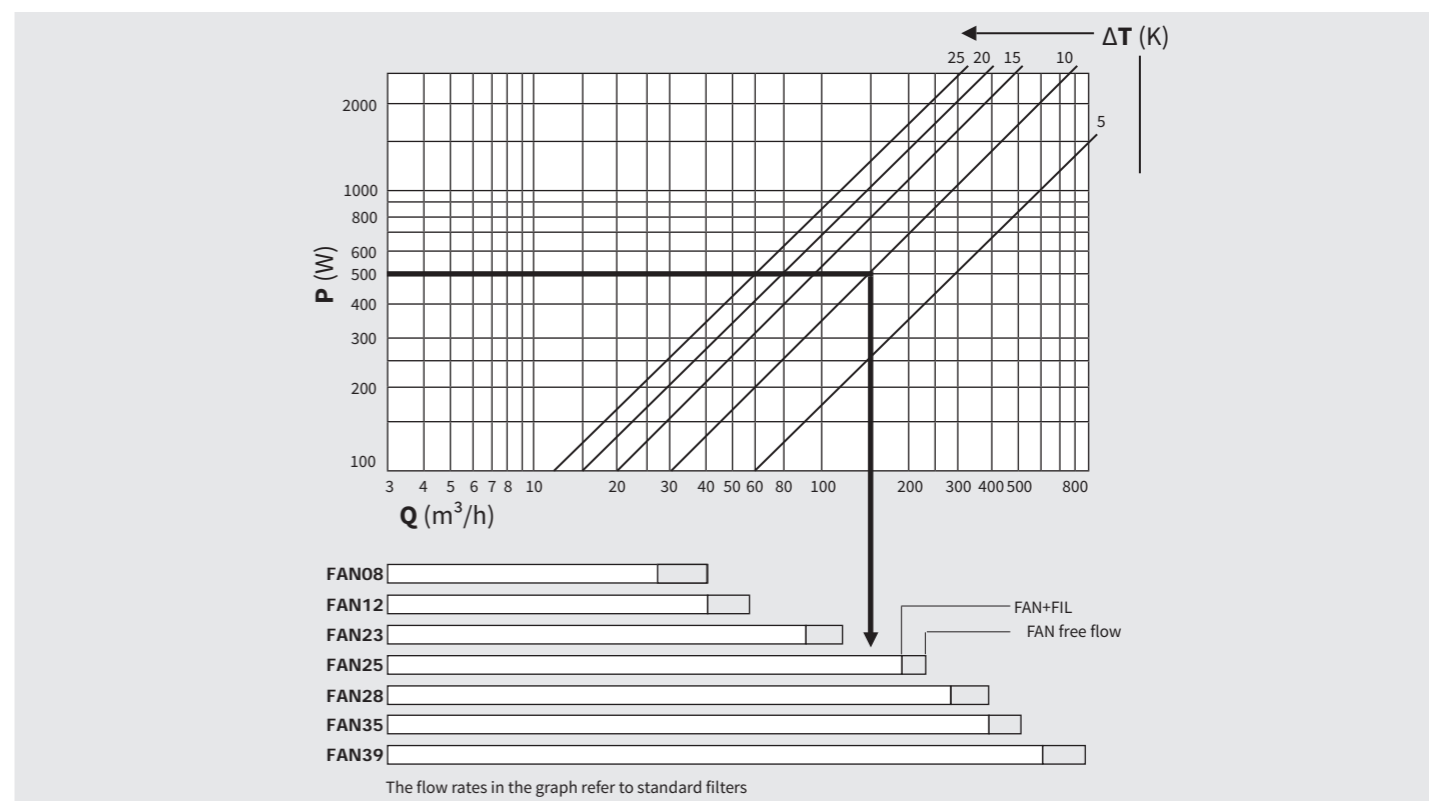

Q = Air flow rate
P = Power dissipated in the cabinet
ΔT = Temperature differential

Example:
Dissipated power 500 W
Temperature differential 10 K
Necessary flow rate 160 m³/h } Unit chosen **FAN25**



Application tips

- When choosing the FAN unit, retain a safety margin of at least 10% to take into account the decrease in flow rate caused when the fabric filter gets dirty.
- If possible, always favour the use of units with the air flow from the exterior of the cabinet to the interior. The resulting slight increase in pressure inside the cabinet prevents the ingress of dust through any unsealed cracks.
- If using a high-efficiency filter fabric, bear in mind that the air flow will be reduced.
- The use of DC powered FAN units can be the best way to prevent disturbances in monitors or other sensitive equipment inside the cabinet.

The FAN unit can be installed in conjunction with a N/O thermostat (AAFTO12) which provides power to it only when the temperature exceeds a set threshold (e.g. 35°C). The Fan operates only when it is required to provide cooling, saving energy, extending the life of the fabric filter and reducing maintenance.

FAN08

Ventilation units with filter

AIR FLOW RATE

36/41 - 44 m³/h



Performance

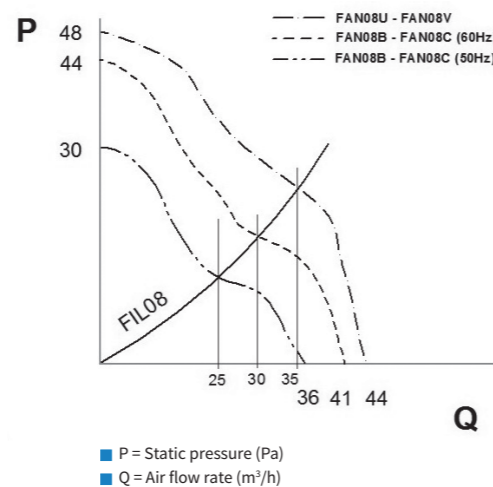

Features	UoM	FIL08XN0B	FAN08BN0B	FAN08CN0B	FAN08UN0B	FAN08VN0B
Air flow rate	m ³ /h	-	36 - 41	36 - 41	44	44
Power supply	V ~ Hz	-	230 1~ 50-60	115 1~ 50-60	24 V DC	48 V DC
Dimensions HxWxD	mm	114x114x21	114x114x64	114x114x64	114x114x64	114x114x64
Power draw	W	-	15 - 13	15 - 12	5	6
Max current	A	-	0.14 - 0.13	0.07 - 0.06	0.18	0.12
Overcurrent protection	-	-	Internal motor	Internal motor	Internal motor	Internal motor
Electrical connection	-	-	Faston	Faston	Faston	Faston
Operating cycle	-	-	100%	100%	100%	100%
Temperature limits	°C	-30+75	-10+50	-10+50	-10+50	-10+50
IP rating EN60529	-	IP54	IP54	IP54	IP54	IP54
Noise level	dB (A)	-	30 - 32	30 - 32	36	36
FAN + FIL air flow rate	m ³ /h	-	1xFIL08XN0B: 25 - 30 1xFIL12XN0B: 28 - 33		1xFIL08XN0B: 35 1xFIL12XN0B: 38	
Air flow direction	-	-	Ext to int. Reversible	Ext to int. Reversible	Ext to int. Reversible	Ext to int. Reversible
Filter (Eurovent)	-	EU4	EU4	EU4	EU4	EU4
Motor support	-	-	Bearings	Bearings	Bearings	Bearings
Lifetime L ₁₀	h	-	45000	45000	60000	60000
Weight	kg	0.1	0.5	0.5	0.5	0.5
Colour	-	RAL 7035 embossed effect				
Conformity	-	CE	CE	CE	CE	CE

FAN08

Dimensions

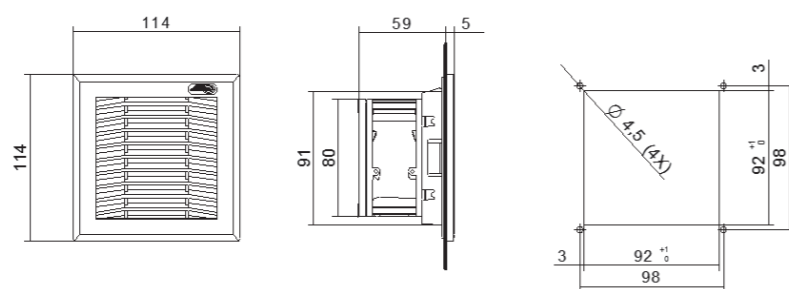

FIL08

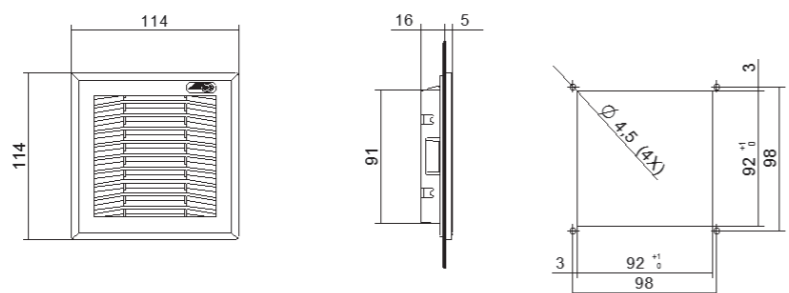

Drilling templates

N.B.: The drilling templates are only approximate.
For any requirements, contact our technical/sales office.

Accessories

Pack of 10 fabric filters for FAN08	AAFFN08
Pack of 10 high-efficiency fabric filters for FAN08	AAFFH08
0-60°C thermostat, normally open 10A	AAFTO12
5-60°C thermostat, change-over contact 10A	AAWTS10
Bellows kit for IP55 ingress protection	C12Z01045

FAN12

Ventilation units with filter

AIR FLOW RATE

57/61 - 60 m³/h



Performance

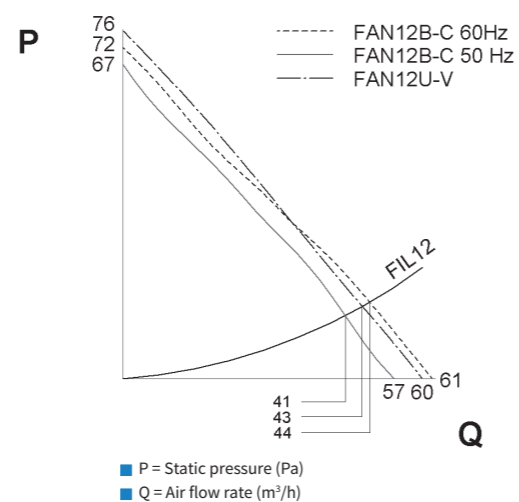

Features	UoM	FIL12XN0B	FAN12BN0B	FAN12CN0B	FAN12UN0B	FAN12VN0B
Air flow rate	m ³ /h	-	57 - 61	57 - 61	60	60
Power supply	V - Hz	-	230 1~ 50-60	115 1~ 50-60	24 V DC	48 V DC
Dimensions HxWxD	mm	150x150x24	150x150x67	150x150x67	150x150x67	150x150x67
Power draw	W	-	21 - 18	21 - 18	7	9
Max current	A	-	0.13 - 0.11	0.28 - 0.22	0.26	0.18
Overcurrent protection	-	-	Internal motor	Internal motor	Internal motor	Internal motor
Electrical connection	-	-	Faston	Faston	Faston	Faston
Operating cycle	-	-	100%	100%	100%	100%
Temperature limits	°C	-30+75	-10+50	-10+50	-10+50	-10+55
IP rating EN60529	-	IP54	IP54	IP54	IP54	IP54
Noise level	dB (A)	-	43 - 48	43 - 48	43	43
FAN + FIL air flow rate	m ³ /h	-	1xFIL12XN0B: 41 - 44 1xFIL25XN0B: 47 - 51		1xFIL12XN0B: 43 1xFIL25XN0B: 49	
Air flow direction	-	-	Ext to int. Reversible	Ext to int. Reversible	Ext to int. Reversible	Ext to int. Reversible
Filter (Eurovent)	-	EU4	EU4	EU4	EU4	EU4
Motor support	-	-	Bearings	Bearings	Bearings	Bearings
Lifetime L ₁₀	h	-	45000	45000	60000	60000
Weight	kg	0.1	0.7	0.7	0.7	0.7
Colour	-	RAL 7035 embossed effect				
Conformity	-	CE	CE	CE	CE	CE

FAN12

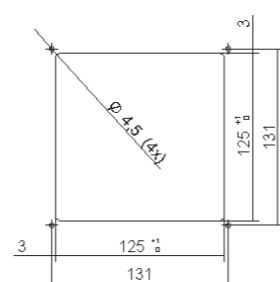
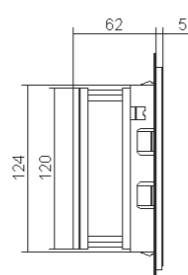
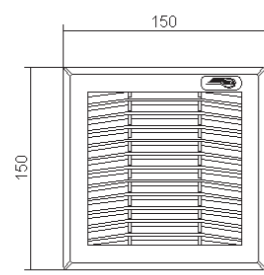

FIL12

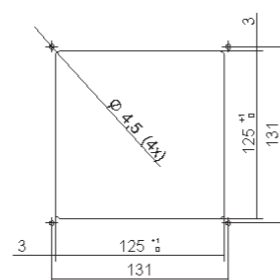
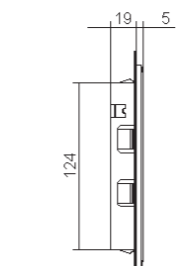
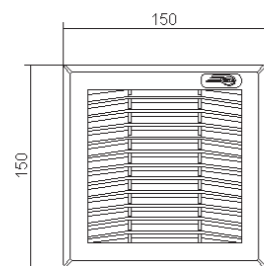

Drilling templates

N.B.: The drilling templates are only approximate.
For any requirements, contact our technical/sales office.

Accessories

Pack of 10 fabric filters for FAN12	AAFFN12
Pack of 10 high-efficiency fabric filters for FAN12	AAFFH12
0-60°C thermostat, normally open 10A	AAFTO12
5-60°C thermostat, change-over contact 10A	AAWTS10
Bellows kit for IP55 ingress protection	C12Z01045

FAN23

Ventilation units with filter

AIR FLOW RATE

115/125 - 120 m³/h



Performance

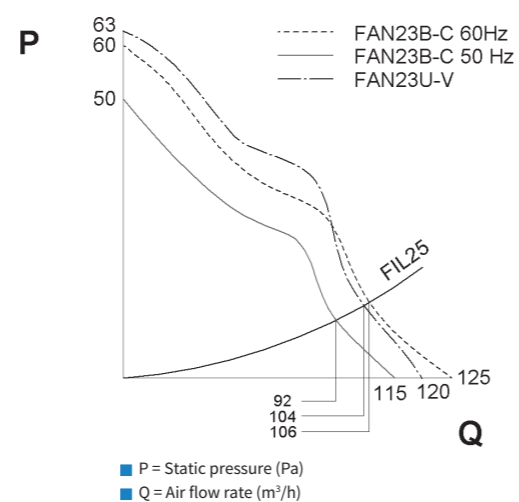

Features	UoM	FIL25XN0B	FAN23BN0B	FAN23CN0B	FAN23UN0B	FAN23VN0B
Air flow rate	m ³ /h	-	115 - 125	115 - 125	120	120
Power supply	V - Hz	-	230 1~ 50-60	115 1~ 50-60	24 V DC	48 V DC
Dimensions HxWxD	mm	250x250x26	250x250x102	250x250x102	250x250x102	250x250x102
Power draw	W	-	21 - 18	21 - 18	7	9
Max current	A	-	0.13 - 0.11	0.28 - 0.22	0.26	0.18
Overcurrent protection	-	-	Internal motor	Internal motor	Internal motor	Internal motor
Electrical connection	-	-	Faston	Faston	Faston	Faston
Operating cycle	-	-	100%	100%	100%	100%
Temperature limits	°C	-30+75	-10+50	-10+50	-10+50	-10+55
IP rating EN60529	-	IP54	IP54	IP54	IP54	IP54
Noise level	dB (A)	-	43 - 48	43 - 48	43	43
FAN + FIL air flow rate	m ³ /h	-	1xFIL25XN0B: 92 - 106 1xFIL35XN0B: 101 - 111		1xFIL25XN0B: 104 1xFIL35XN0B: 111	
Air flow direction	-	-	Ext to int. Reversible	Ext to int. Reversible	Ext to int. Reversible	Ext to int. Reversible
Filter (Eurovent)	-	EU4	EU4	EU4	EU4	EU4
Motor support	-	-	Bearings	Bearings	Bearings	Bearings
Lifetime L ₁₀	h	-	45000	45000	60000	60000
Weight	kg	0.4	1.1	1.1	1.1	1.1
Colour	-	RAL 7035 embossed effect				
Conformity	-	CE	CE	CE	CE	CE

FAN23

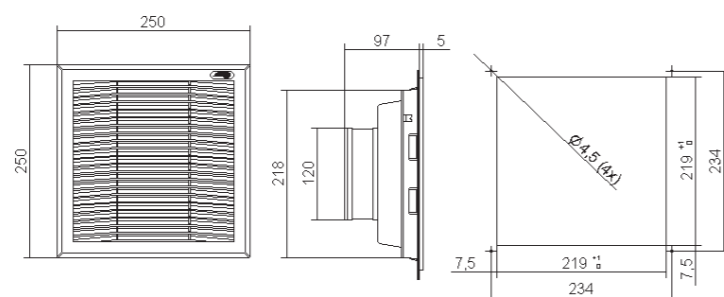

Dimensions

FIL25

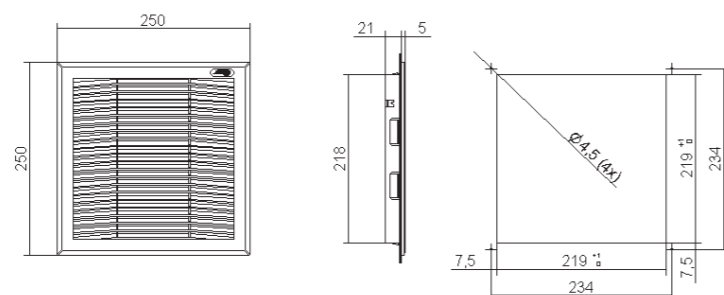

Drilling templates

Accessories

Pack of 10 fabric filters for FAN23-25	AAFFN25
Pack of 10 high-efficiency fabric filters for FAN23-25	AAFFH25
0-60°C thermostat, normally open 10A	AAFTO12
5-60°C thermostat, change-over contact 10A	AAWTS10
Bellows kit for IP55 ingress protection	C12Z01049

N.B.: The drilling templates are only approximate.
For any requirements, contact our technical/sales office.

FAN25

Ventilation units with filter

AIR FLOW RATE

230/262 - 230 m³/h



Performance

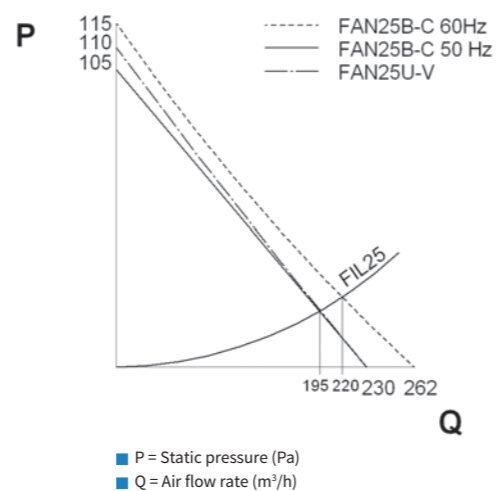

Features	UoM	FIL25XN0B	FAN25BN0B	FAN25CN0B	FAN25UN0B	FAN25VN0B
Air flow rate	m ³ /h	-	230 - 262	230 - 262	230	230
Power supply	V ~ Hz	-	230 1~ 50-60	115 1~ 50-60	24 V DC	48 V DC
Dimensions HxWxD	mm	250x250x26	250x250x114	250x250x114	250x250x114	250x250x114
Power draw	W	-	45 - 40	45 - 40	23	20
Max current	A	-	0.35 - 0.28	0.65 - 0.55	0.95	0.42
Overcurrent protection	-	-	Internal motor	Internal motor	Internal motor	Internal motor
Electrical connection	-	-	Faston	Faston	Faston	Faston
Operating cycle	-	-	100%	100%	100%	100%
Temperature limits	°C	-30+75	-10+50	-10+50	-10+50	-10+55
IP rating EN60529	-	IP54	IP54	IP54	IP54	IP54
Noise level	dB (A)	-	56 - 58	56 - 58	50	50
FAN + FIL air flow rate	m ³ /h	-	1x FIL25XN0B: 195 - 220 2x FIL25XN0B: 215 - 233 1x FIL35XN0B: 205 - 228		1x FIL25XN0B: 195 2x FIL25XN0B: 215 1x FIL35XN0B: 205	
Air flow direction	-	-	Ext to int. Reversible	Ext to int. Reversible	Ext to int. Reversible	Ext to int. Reversible
Filter (Eurovent)	-	EU4	EU4	EU4	EU4	EU4
Motor support	-	-	Bearings	Bearings	Bearings	Bearings
Lifetime L ₁₀	h	-	45000	45000	60000	60000
Weight	kg	0.4	1.4	1.4	1.4	1.4
Colour	-	RAL 7035 embossed effect				
Conformity	-	CE	CE	CE	CE	CE

FAN25

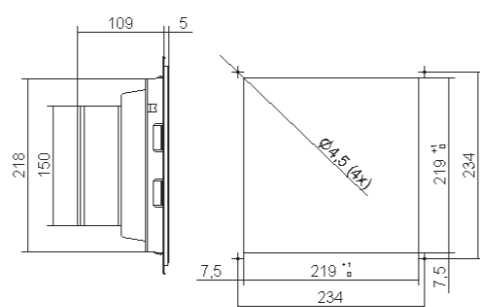
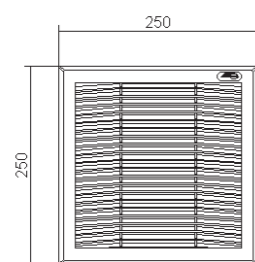

Dimensions

FIL25

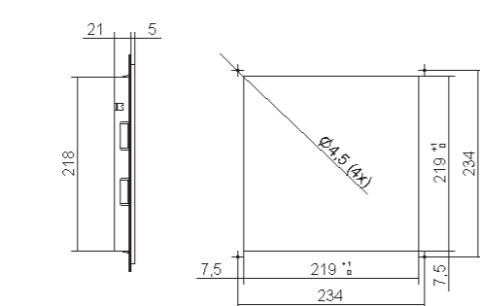
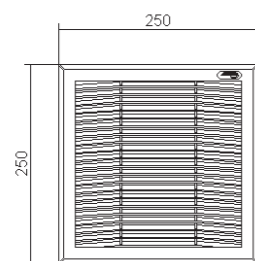

Drilling templates

Accessories

Pack of 10 fabric filters for FAN23-25	AAFFN25
Pack of 10 high-efficiency fabric filters for FAN23-25	AAFFH25
0-60°C thermostat, normally open 10A	AAFTO12
5-60°C thermostat, change-over contact 10A	AAWTS10
Bellows kit for IP55 ingress protection	C12Z01049

N.B.: The drilling templates are only approximate.
For any requirements, contact our technical/sales office.

FAN28

Ventilation units with filter

AIR FLOW RATE

400 - 440 m³/h



Performance

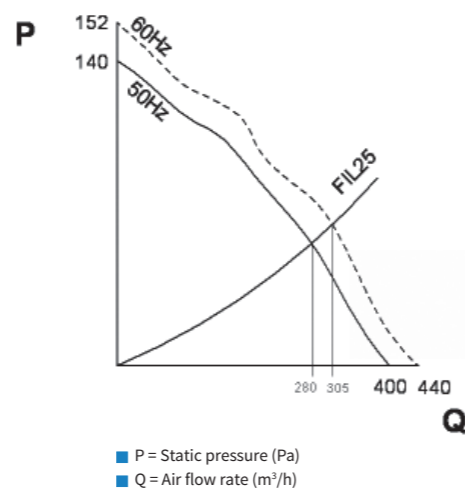

Features	UoM	FIL25XN0B	FAN28BN0B	FAN28CN0B	FAN28LN0B
Air flow rate	m ³ /h	-	400 - 440	400 - 440	400 - 440
Power supply	V ~ Hz	-	230 1~ 50-60	115 1~ 50-60	400 3~ 50-60
Dimensions HxWxD	mm	250x250x26	250x250x98	250x250x98	250x250x98
Power draw	W	-	85 - 115	85 - 115	85 - 115
Max current	A	-	0.38 - 0.50	0.70 - 0.90	0.18 - 0.18
Overcurrent protection	-	-	Internal motor	Internal motor	Internal motor
Electrical connection	-	-	Faston	Faston	Terminal board
Operating cycle	-	-	100%	100%	100%
Temperature limits	°C	-30+75	-10+50	-10+50	-10+50
IP rating EN60529	-	IP54	IP54	IP54	IP54
Noise level	dB (A)	-	61 - 63	61 - 63	61 - 63
FAN + FIL air flow rate	m ³ /h	-	1x FIL25XN0B: 280 - 305 2x FIL25XN0B: 297 - 318 1x FIL35XN0B: 308 - 332		
Air flow direction	-	-	Ext to int. Reversible	Ext to int. Reversible	Ext to int. Reversible
Filter (Eurovent)	-	EU4	EU4	EU4	EU4
Motor support	-	-	Bearings	Bearings	Bearings
Lifetime L ₁₀	h	-	45000	45000	45000
Weight	kg	0.4	2.7	2.7	2.7
Colour	-	RAL 7035 embossed effect			
Conformity	-	CE	CE	CE	CE

FAN28

Dimensions

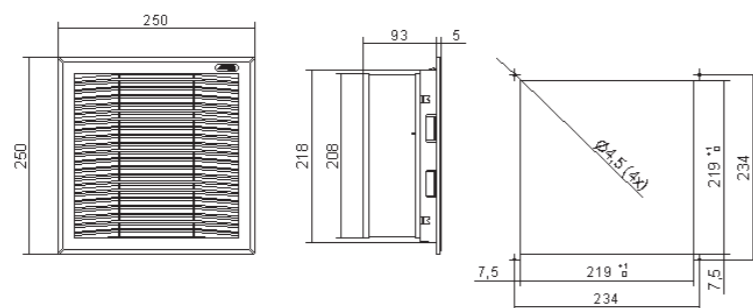

FIL25

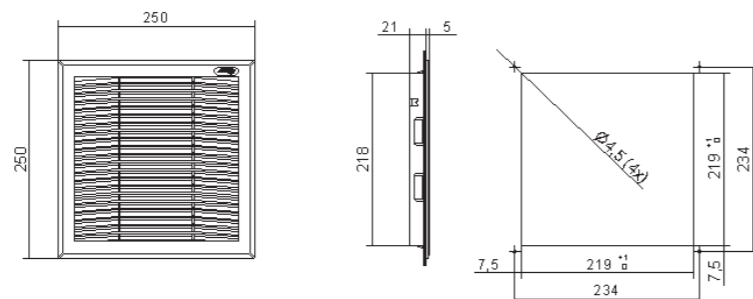

Drilling templates

N.B.: The drilling templates are only approximate.
For any requirements, contact our technical/sales office.

Accessories

Pack of 10 fabric filters for FAN23-25	AAFFN25
Pack of 10 high-efficiency fabric filters for FAN23-25	AAFFH25
0-60°C thermostat, normally open 10A	AAFTO12
5-60°C thermostat, change-over contact 10A	AAWTS10
Bellows kit for IP55 ingress protection	C12Z01049

FAN35

Ventilation units with filter

AIR FLOW RATE

520 - 580 m³/h



Performance

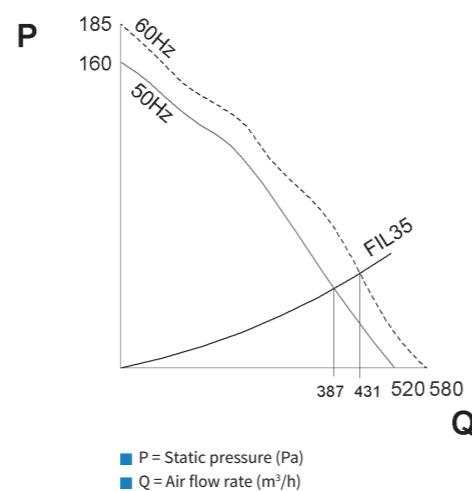

Features	UoM	FIL35XN0B	FAN35BN0B	FAN35CN0B	FAN35LN0B
Air flow rate	m ³ /h	-	520 - 580	520 - 580	520 - 580
Power supply	V - Hz	-	230 1~ 50-60	115 1~ 50-60	400 3~ 50-60
Dimensions HxWxD	mm	325x325x28	325x325x153	325x325x153	325x325x153
Power draw	W	-	85 - 115	85 - 115	85 - 115
Max current	A	-	0.38 - 0.50	0.70 - 0.90	0.18 - 0.18
Overcurrent protection	-	-	Internal motor	Internal motor	Internal motor
Electrical connection	-	-	Faston	Faston	Terminal board
Operating cycle	-	-	100%	100%	100%
Temperature limits	°C	-30+75	-10+50	-10+50	-10+50
IP rating EN60529	-	IP54	IP54	IP54	IP54
Noise level	dB (A)	-	61 - 63	61 - 63	61 - 63
FAN + FIL air flow rate	m ³ /h	-	1xFIL35XN0B: 387 - 431	1xFIL35XN0B: 387 - 431	1xFIL35XN0B: 387 - 431
Air flow direction	-	-	Ext to int. Reversible	Ext to int. Reversible	Ext to int. Reversible
Filter (Eurovent)	-	EU4	EU4	EU4	EU4
Motor support	-	-	Bearings	Bearings	Bearings
Lifetime L ₁₀	h	-	45000	45000	45000
Weight	kg	0.6	3.1	3.1	3.1
Colour	-	RAL 7035 embossed effect			
Conformity	-	CE	CE	CE	CE

FAN35

Dimensions

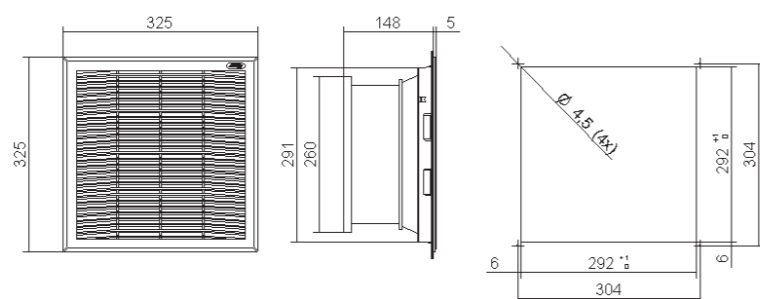

FIL35

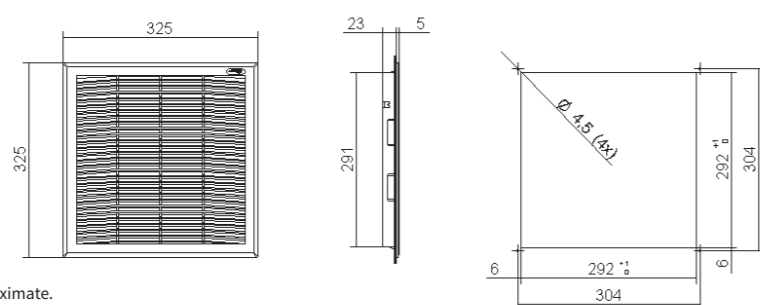

Drilling templates

N.B.: The drilling templates are only approximate.
For any requirements, contact our technical/sales office.

Accessories

Pack of 10 fabric filters for FAN35	AAFFN35
Pack of 10 high-efficiency fabric filters for FAN35	AAFFH35
0-60°C thermostat, normally open 10A	AAFTO12
5-60°C thermostat, change-over contact 10A	AAWTS10
Bellows kit for IP55 ingress protection	C12Z01052

FAN39

Ventilation units with filter

AIR FLOW RATE

920 - 940 m³/h



Features	UoM	FIL35XN0B	FAN39BN0B	FAN39CN0B
Air flow rate	m ³ /h	-	920 - 940	920 - 940
Power supply	V - Hz	-	230 1~ 50-60	115 1~ 50-60
Dimensions HxWxD	mm	325x325x28	325x325x118	325x325x118
Power draw	W	-	105 - 140	110 - 136
Max current	A	-	0.48 - 0.62	1.10 - 1.20
Overcurrent protection	-	-	Internal motor	Internal motor
Electrical connection	-	-	Terminal board	Terminal board
Operating cycle	-	-	100%	100%
Temperature limits	°C	-30+75	-10+50	-10+50
IP rating EN60529	-	IP54	IP54	IP54
Noise level	dB (A)	-	65 - 68	65 - 68
FAN + FIL air flow rate	m ³ /h	-	1 x FIL35XN0B: 580 - 620	1 x FIL35XN0B: 580 - 620
Air flow direction	-	-	Ext to int. Reversible	Ext to int. Reversible
Filter (Eurovent)	-	EU4	EU4	EU4
Motor support	-	-	Bearings	Bearings
Lifetime L ₁₀	h	-	50000	50000
Weight	kg	0.6	4.8	4.8
Colour	-	RAL 7035 embossed effect		
Conformity	-	CE	CE	CE

Accessories	
Pack of 10 fabric filters for FAN35	AAFFN35
Pack of 10 high efficiency fabric filters for FAN35	AAFFH35
0-60°C thermostat, normally open 10A	AAFTO12
5-60°C thermostat, change-over contact 10A	AAWTS10
Bellows kit for IP55 ingress protection	C12Z01052

Performance

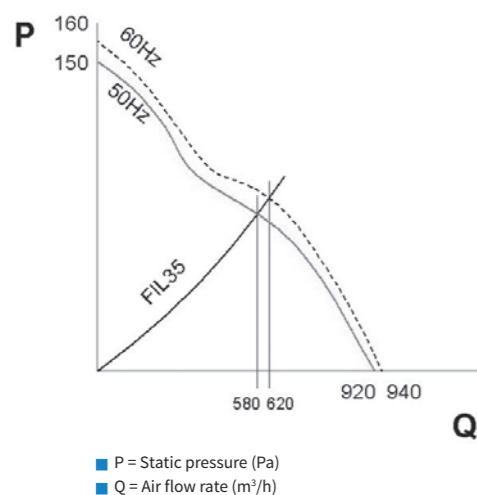

Dimensions

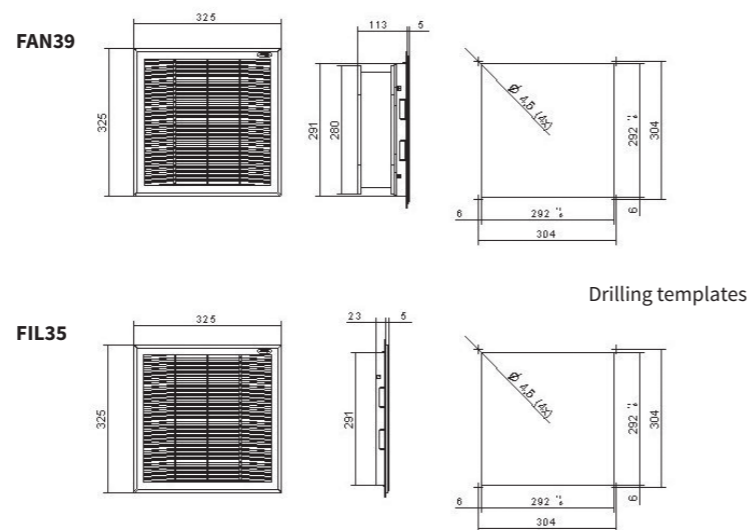

N.B.: The drilling templates are only approximate.
 For any requirements, contact our technical/sales office.



DLK

Roof-mount fans

A tough frame combined with an attractive design sets the DLK range of roof ventilators apart.



DLK

Roof-mount fans

APPLICATION

Featuring easy installation and an attractive, innovative design, the DLK range of roof-mount fans are the ideal solution when there is no space on the cabinet walls, or the air flow is higher than that available with the FAN range of ventilated grilles.

AVAILABLE AIR FLOW RATES

Available in 6 sizes: from 600 to 4000 m³/h. The fans used are centrifugal models with motor shafts with bearings. High quality and with high volumetric efficiency, they have an expected lifetime of 50,000 hours at an ambient temperature of 40 °C.

HIGH IP RATING

The special configuration of the covering structure and the self-adhesive seal for coupling to the enclosure allow DLK/DLR units to achieve an IP44 rating. On request, a filter kit is available which allows an IP54 rating to be achieved.

NATURAL VENTILATION UNIT

A version without fan is also available: DLR19XX0B. This is used when natural ventilation is sufficient to cool the cabinet and you wish to maintain a high IP rating for the cabinet.

AVAILABLE POWER SUPPLIES

DLK roof-mount fans are available for 230V and 115V single-phase power supplies. On request, versions for supply voltages not present in the catalogue can be produced for orders of sufficient quantities.

LOW NOISE LEVEL

Reduction of noise levels is a precise criteria aimed for when developing the DLK units. They have been designed to minimise disturbance from noise and thus help provide quiet working environments.

FILTER UNIT

DLK roof-mount fans can be used together with the FIL35XN0B filter grille for intake of air in the cabinet.

Selection diagram for roof-mount fans

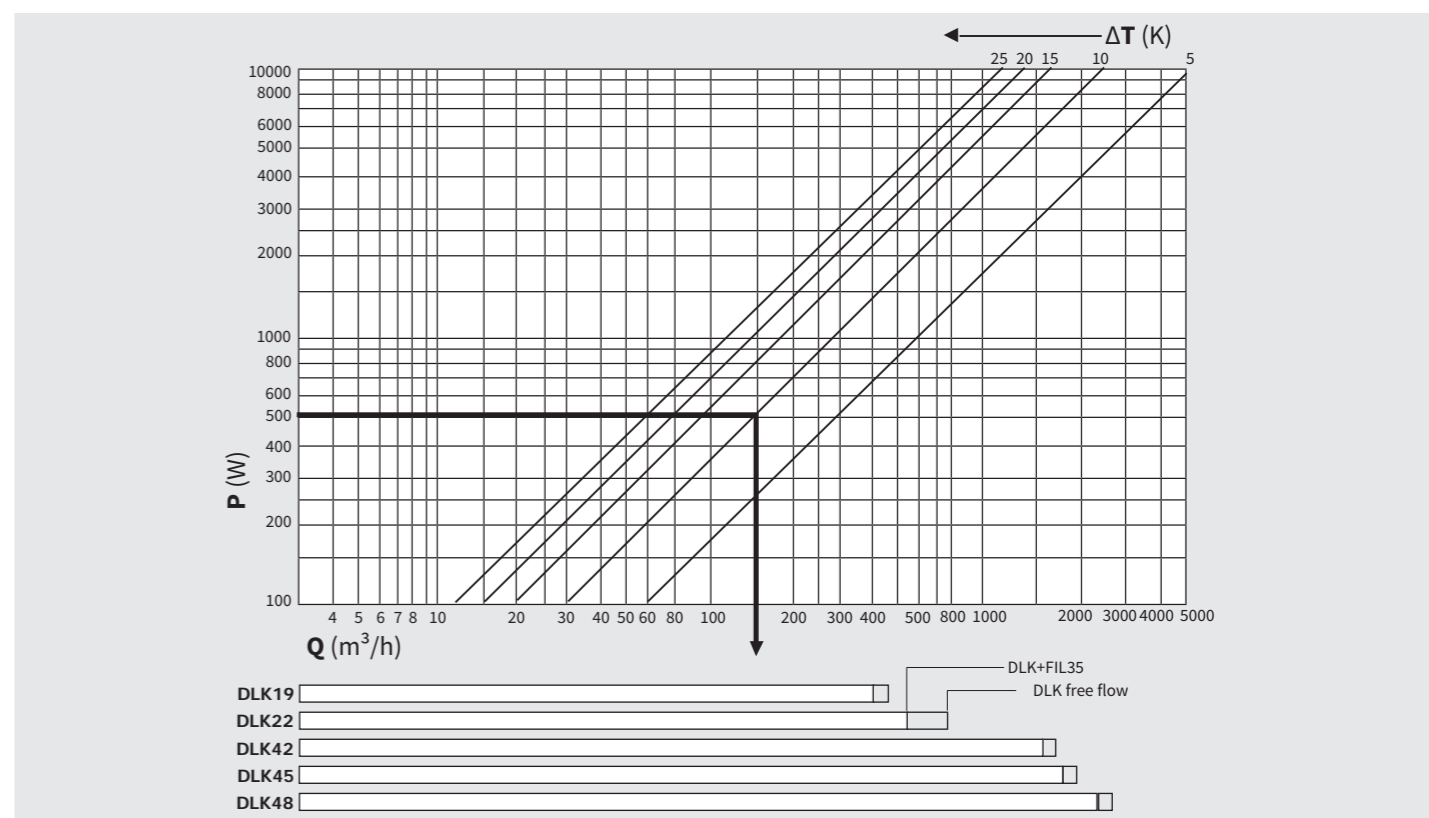

Q = Air flow rate
P = Power dissipated in the cabinet
ΔT = Temperature differential

Example:

Dissipated power	500 W	} Unit chosen
Temperature differential	10 K	
Necessary flow rate	160 m ³ /h	
		DLK19



Application tips

- When choosing the DLK roof-mount fan, retain a safety margin of at least 10% to take into account the decrease in flow rate caused when the fabric filter gets dirty.
- If using a high-efficiency filter fabric, bear in mind that the air flow will be reduced.
- The DLK roof-mount fan can be installed via a thermostat which provides power to it only when the temperature exceeds a set threshold (e.g. 35°C). In this way the fan operates only when it is needed to provide cooling, saving energy, extending the life of the fabric filter and reducing maintenance.

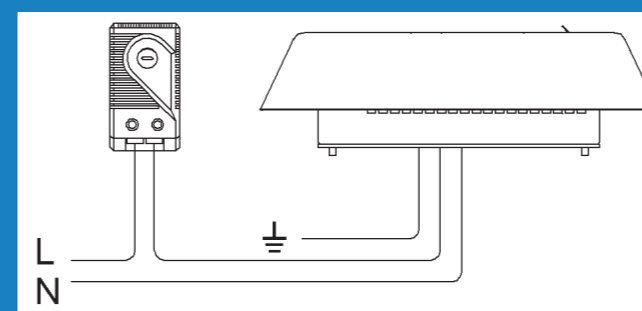

Control scheme for a roof-mount fan using AAFTO12 thermostat



DLK19-22-25

Roof-mount fans

AIR FLOW RATE

600-625 - 1050-1085 - 1380-1460 m³/h

Performance

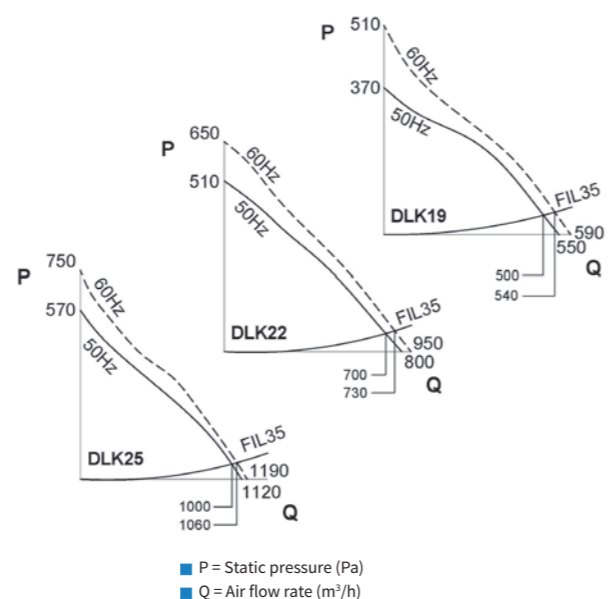

Dimensions

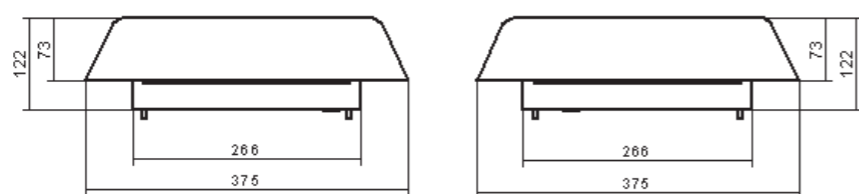

Drilling templates

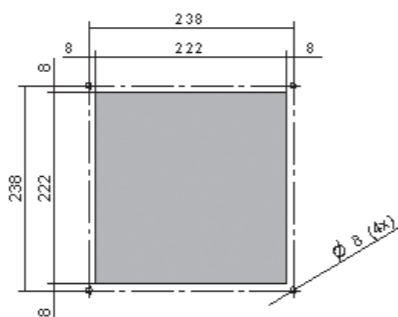

N.B.: The drilling templates are only approximate.
 For any requirements, contact our technical/sales office.

Features	UoM	DLR19XX0B	DLK19BX0B	DLK19CX0B	DLK22BX0B	DLK22CX0B	DLK25BX0B
Air flow rate	m ³ /h	-	600 - 625	600 - 625	1050 - 1085	1050 - 1085	1380 - 1460
Fan+tower air flow capacity	m ³ /h	-	550 - 590	550 - 590	800 - 950	800 - 950	1120 - 1190
Power supply	V - Hz	-	230 1~ 50-60	115 1~ 50-60	230 1~ 50-60	115 1~ 50-60	230 1~ 50-60
Dimensions HxWxD	mm	122x375x375	122x375x375	122x375x375	122x375x375	122x375x375	122x375x375
Power draw	W	-	78 - 106	58 - 77	123 - 168	143 - 200	135 - 200
Max current	A	-	0.32 - 0.4	0.58 - 0.73	0.52 - 0.65	1.13 - 1.42	0.6 - 0.88
Overcurrent protection	-	-	Internal motor	Internal motor	Internal motor	Internal motor	Internal motor
Electrical connection	-	-	Cable	Cable	Cable	Cable	Cable
Operating cycle	-	-	100%	100%	100%	100%	100%
Temperature limits	°C	-20+60	-20+60	-20+60	-20+60	-20+60	-20+60
IP rating EN60529	-	IP44	IP44	IP44	IP44	IP44	IP44
Noise level	dB (A)	-	62 - 64	62 - 64	72 - 71	72 - 71	70 - 72
DLK + FIL35XN0B air flow capacity	m ³ /h	-	500 - 540	500 - 540	700 - 730	700 - 730	1000 - 1060
Air flow direction	-	-	Interior to exterior	Interior to exterior	Interior to exterior	Interior to exterior	Interior to exterior
Motor support	-	-	Bearings	Bearings	Bearings	Bearings	Bearings
Weight	kg	4	6	6	7	7	7
Colour	-	RAL 7035 embossed effect					
Conformity	-	CE	CE	CE	CE	CE	CE

Accessories

Grille with filter 325x325 mm	FIL35XN0B
Pack of 10 fabric filters for FAN35	AAFFN35
0-60°C thermostat, normally open 10A	AAFTO12
5-60°C thermostat, change-over contact 10A	AAWTS10
Filter kit for IP54 ingress protection	C15000376

DLK42-45-48

Roof-mount fans

AIR FLOW RATE

2300-2530 - 3000-3370 - 4000-4520 m³/h

Performance

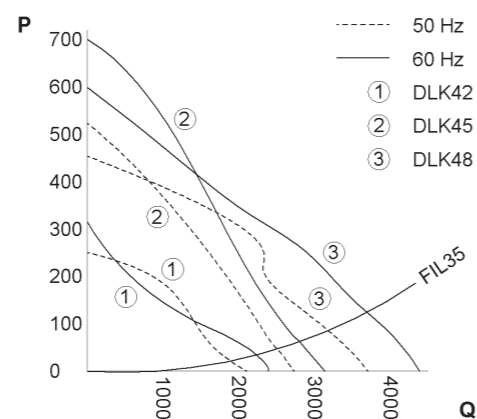

Features	UoM	DLR42XX0B	DLK42BX0B	DLK45BX0B	DLK48BX0B
Fan air flow capacity	m ³ /h	-	2300 - 2530	3000 - 3370	4000 - 4520
Fan+tower air flow capacity	m ³ /h	-	2110 - 2390	2750 - 3180	3670 - 4270
Power supply	V ~ Hz	-	230 1~ 50-60	230 1~ 50-60	230 1~ 50-60
Dimensions HxWxD	mm	272x637x637	272x637x637	272x637x637	272x637x637
Power draw	W	-	240 - 340	290 - 390	340 - 420
Max current	A	-	0.9 - 1.1	1.2 - 1.4	1.7 - 1.8
Overcurrent protection	-	-	Internal motor	Internal motor	Internal motor
Electrical connection	-	-	Cable	Cable	Cable
Operating cycle	-	-	100%	100%	100%
Temperature limits	°C	-20+60	-20+60	-20+60	-20+60
IP rating EN60529	-	IP44	IP44	IP44	IP44
Noise level	dB (A)	-	62 - 64	72 - 74	71 - 74
DLK + 6 FIL35XN0B air flow capacity	m ³ /h	-	1920 - 2200	2520 - 2930	3340 - 3930
Air flow direction	-	-	Interior to exterior	Interior to exterior	Interior to exterior
Motor support	-	-	Bearings	Bearings	Bearings
Weight	kg	17	27	27	27
Colour	-	RAL 7035 embossed effect			
Conformity	-	CE	CE	CE	CE

Dimensions

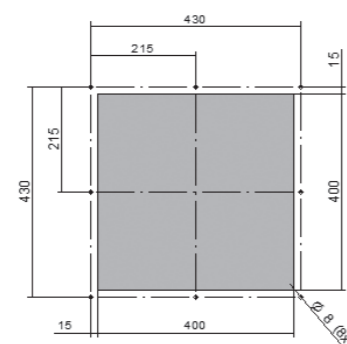
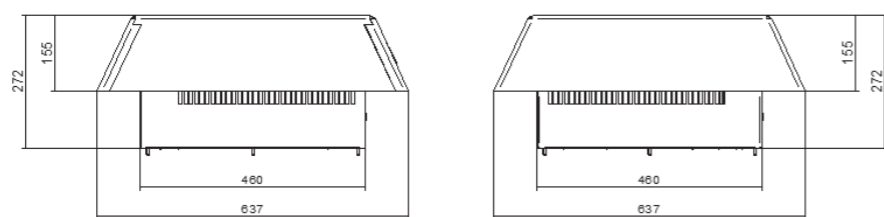

Drilling templates

Accessories	
Grille with filter 325x325 mm	FIL35XN0B
Pack of 10 fabric filters for FAN35	AAFFN35
0-60°C thermostat, normally open 10A	AAFTO12
5-60°C thermostat, change-over contact 10A	AAWTS10
Filter kit for IP54 ingress protection	C15X00000

N.B.: The drilling templates are only approximate.
For any requirements, contact our technical/sales office.

WID

Anti-condensation heaters

Compatible, reliable and safe. The WID range offers a huge range of solutions for electrical cabinet heating.



WID

Anti-condensation heaters

APPLICATION

Heaters are required to prevent faults or corrosion due to excessively low temperatures or high humidity levels inside the cabinet. These conditions can occur when the ambient temperature is low and the equipment inside the cabinet is not powered or does not dissipate sufficient heat to keep the internal temperature above a minimum threshold. Outdoor cabinets are almost always found in these conditions.

SAFETY

The surface temperature is limited via PTC. This allows for safe operation and self-regulated heating power. All heaters are Class I except for the WID..ZXOP and WID..BL0T range of heaters, which are Class II.

SPEED OF INSTALLATION

Installation is quick and easy. All units have provision for snap-on installation onto 35 mm EN 50022 DIN rail.

LONG LIFE

The fan heaters are equipped with fans with shaft bearing. High quality and with high volumetric efficiency, they have an expected lifetime of 50,000 hours at an ambient temperature of 25 °C.

FLEXIBLE POWER SUPPLY

The WID range of heaters in the catalogue have the following power supplies:

- WID..ZX0X 110-250 V AC/DC
- WID..ZX0P 110-250 V AC/DC
- WID..BL0C 230 V 50/60 Hz
- WID..BL0T 230 V 50/60 Hz

WIDE RANGE

Compact, reliable and high performance, WID series heaters cover a range of heating outputs from 10 to 550 W and are available in four types:

- WID..ZX0X Standard
- WID..ZX0P Protected surface
- WID..BL0C Compact fan
- WID..BL0T Fan with integrated thermostat

SPECIAL PRODUCTS

On request, versions for voltages not present in the catalogue can be produced for orders of sufficient quantities.

Heater selection diagram

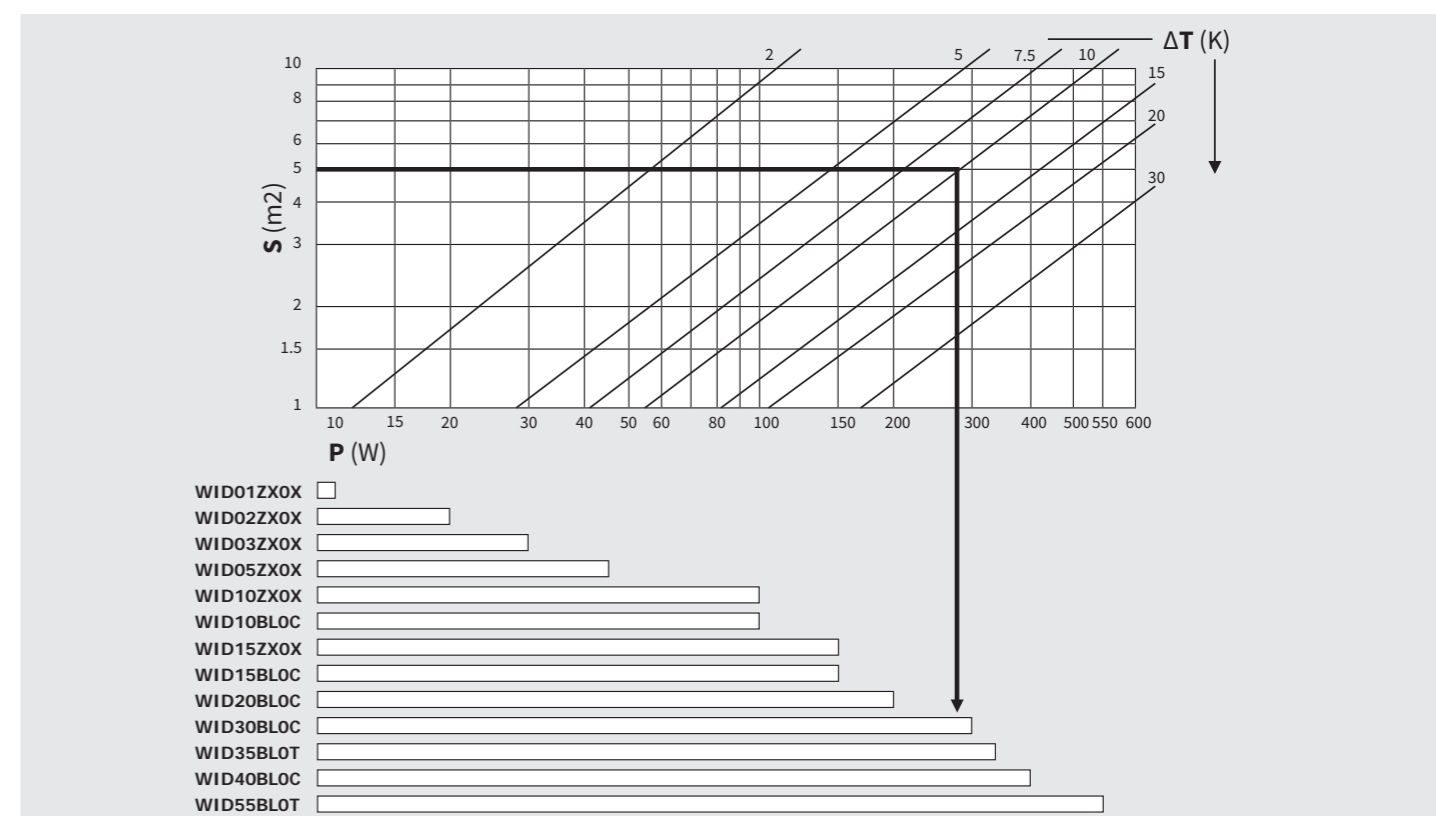

P = Heating power
S = Cabinet surface area
ΔT = Temperature differential

Example:

Cabinet surface area 5 m²
Temperature differential 10 K
Heating power 280W

Unit chosen
WID30BL0C or
WID35BL0T



Application tips

■ In order to achieve optimum temperature control, the heaters must be controlled by a thermostat or humidistat (see Accessories)

■ In order to achieve maximum efficiency, the heaters must be installed in the lower part of the cabinet with the air flow towards the top and the fan and the electrical connection at the bottom. A free space of 50 mm must be left above and below the heater.

■ Thermoplastic electrical components must be kept at least 50 mm from the heater. For large cabinets, it is preferable to install multiple spread out heaters rather than one large, high-power heater. The heat will thus be better distributed.

WID01 - 03ZX0X

Anti-condensation heaters

HEATING POWER

10 - 20 - 30 W



Features	UoM	WID01ZX0X	WID02ZX0X	WID03ZX0X
Heating power*	W	10	20	30
Power supply	V - Hz	110-250 V AC/DC	110-250 V AC/DC	110-250 V AC/DC
Dimensions HxWxD	mm	61x50x25	71x50x25	81x50x25
Max current	A	1	2.5	3
Heating element	-	self-regulated PTC	self-regulated PTC	self-regulated PTC
Electrical connection	-	Cable L = 0.3 m	Cable L = 0.3 m	Cable L = 0.3 m
IEC protection class	-	I	I	I
IP rating EN60529	-	IP54	IP54	IP54
Radiator	-	Extruded aluminium profile	Extruded aluminium profile	Extruded aluminium profile
Clip installation for DIN rail	mm	35	35	35
Weight	kg	0.1	0.2	0.2
Conformity	-	CE	CE	CE

* At 20 °C ambient temperature

Accessories	
Thermostat 0-60°C, normally closed, 10A	AAWTC10
Thermostat 10-60°C, change-over contact, 10A	AAWTS10
Humidistat, RH 35-95% change-over contact, 5A	AAWHS10

WID05 - 15ZX0X

Anti-condensation heaters

HEATING POWER

45 - 100 - 150 W



Features	UoM	WID05ZX0X	WID10ZX0X	WID15ZX0X
Heating power*	W	45	100	150
Power supply	V - Hz	110-250 V AC/DC	110-250 V AC/DC	110-250 V AC/DC
Dimensions HxWxD	mm	109x70x50	184x70x50	264x70x50
Max current	A	3.5	4.5	9
Heating element	-	self-regulated PTC	self-regulated PTC	self-regulated PTC
Electrical connection	-	3 pole Terminal board	3-pole Terminal board	3-pole Terminal board
IEC protection class	-	I	I	I
IP rating EN60529	-	IP20	IP20	IP20
Radiator	-	Extruded aluminium profile	Extruded aluminium profile	Extruded aluminium profile
Clip installation for DIN rail	mm	35	35	35
Weight	kg	0.3	0.5	0.7
Conformity	-	CE	CE	CE

* At 20 °C ambient temperature

Accessories	
Thermostat 0-60°C, normally closed, 10A	AAWTC10
Thermostat 10-60°C, change-over contact, 10A	AAWTS10
Humidistat, RH 35-95% change-over contact, 5A	AAWHS10

Dimensions

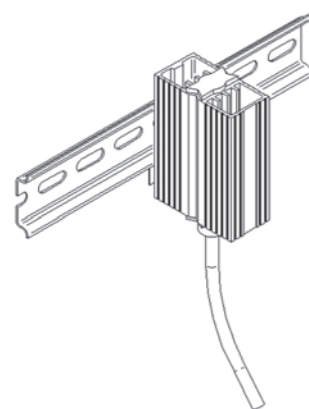

W mm	
WID01ZX0X	50
WID02ZX0X	60
WID03ZX0X	70

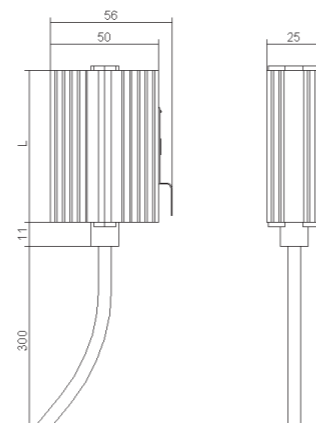

Dimensions



Facilitated installation with quick-connection terminals

W mm	
WID05ZX0X	65
WID10ZX0X	140
WID15ZX0X	220

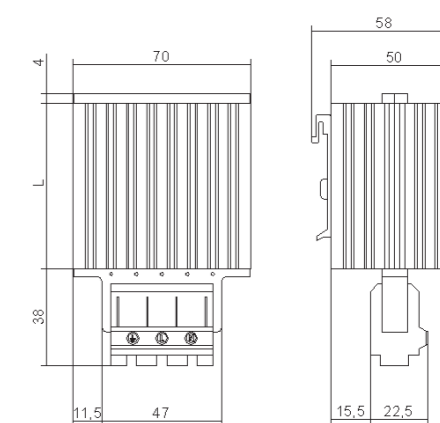

WID05 - 15ZX0P

Anti-condensate heaters with protected surface

HEATING POWER

50 - 100 - 150 W



Features	UoM	WID05ZX0P	WID10ZX0P	WID15ZX0P
Heating power*	W	50	100	150
Power supply	V - Hz	110-250 V AC/DC	110-250 V AC/DC	110-250 V AC/DC
Dimensions HxWxD	mm	110x60x90	150x60x90	150x60x90
Max current	A	2.5	4.5	8
T Fuse	A	4	8	8
Heating element	-	self-regulated PTC	self-regulated PTC	self-regulated PTC
Electrical connection	-	4-pole Terminal board	4-pole Terminal board	4-pole Terminal board
IEC protection class	-	II	II	II
IP rating EN60529	-	IP20	IP20	IP20
Casing	-	Plastic UL94 V-0	Plastic UL94 V-0	Plastic UL94 V-0
Clip installation for DIN rail	mm	35	35	35
Weight	kg	0.3	0.4	0.4
Conformity	-	CE	CE	CE

* At 20 °C ambient temperature

Accessories	
Thermostat 0-60°C, normally closed, 10A	AAWTC10
Thermostat 10-60°C, change-over contact, 10A	AAWTS10
Humidistat, RH 35-95% change-over contact, 5A	AAWHS10

WID..BL0T

Anti-condensate fan heaters with thermostat

HEATING POWER

350 - 550 W



Features	UoM	WID35BL0T	WID55BL0T
Heating power*	W	350	550
Power supply	V - Hz	230 1~ 50-60	230 1~ 50-60
Max current	A	11.0	13.0
Dimensions HxWxD	mm	165x100x128	165x100x128
Heating element	-	self-regulated PTC	self-regulated PTC
Fan	Capacity	m³/h	35
	Support	-	Bearings
	Lifetime at 25°C	h	50,000
Electrical protection	-	For fault on fan	For fault on fan
Temperature limits	°C	0-60	0-60
Electrical connection	-	2-pole terminal board	2-pole terminal board
IEC protection class	-	II	II
IP rating EN60529	-	IP20	IP20
Clip installation for DIN rail	mm	35	35
Weight	kg	0.9	1.1
Conformity	-	CE	CE

* At 20 °C ambient temperature

Accessories	
Thermostat 10-60°C, change-over contact, 10A	AAWTS10
Humidistat, RH 35-95% change-over contact, 5A	AAWHS10

Dimensions

Connection example

W mm	
WID05ZX0P	110
WID10ZX0P	150
WID15ZX0P	150

Dimensions

■ P = Heating capacity (W)
■ T = Temperature (°C)

WID..BLOC

Compact anti-condensate fan heaters

HEATING POWER

100 - 150 - 200 - 300 - 400 W



Composition of the heater-fan assembly

Dimensions

WID10BLOC
WID15BLOC

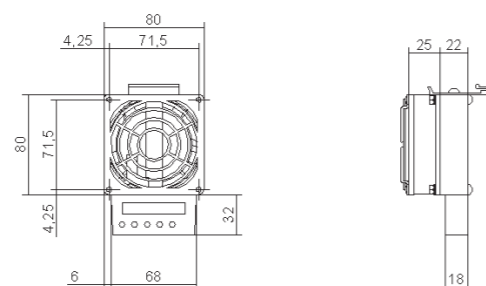

WID20BLOC
WID30BLOC
WID40BLOC

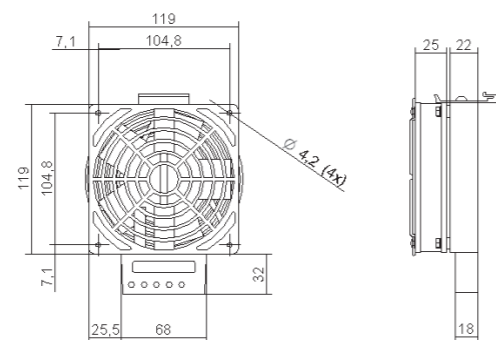

Features	UoM	WID10BLOC	WID15BLOC	WID20BLOC	WID30BLOC	WID40BLOC
Heating power	W	100	150	200	300	400
Power supply	V ~ Hz	230 1~ 50-60	230 1~ 50-60	230 1~ 50-60	230 1~ 50-60	230 1~ 50-60
Dimensions HxWxD	mm	112x80x47	112x80x47	151x119x47	151x119x47	151x119x47
Heating element	-	High-efficiency heater cartridge	High-efficiency heater cartridge	High-efficiency heater cartridge	High-efficiency heater cartridge	High-efficiency heater cartridge
Fan	Capacity	m ³ /h	35	35	108	108
	Support	-	Bearings	Bearings	Bearings	Bearings
	Lifetime at 25°C	h	50,000	50,000	50,000	50,000
Electrical protection	-	For fault on fan	For fault on fan	For fault on fan	For fault on fan	For fault on fan
Outlet air temperature*	°C	45	45	45	45	45
Heating element electrical connection	-	3-pole terminal board	3-pole terminal board	3-pole terminal board	3-pole terminal board	3-pole terminal board
Fan electrical connection	-	2-pole terminal board	2-pole terminal board	2-pole terminal board	2-pole terminal board	2-pole terminal board
IEC protection class	-	I	I	I	I	I
IP rating EN60529	-	IP20	IP20	IP20	IP20	IP20
Radiator	-	Die-cast aluminium	Die-cast aluminium	Die-cast aluminium	Die-cast aluminium	Die-cast aluminium
Clip installation for DIN rail	mm	35	35	35	35	35
Weight	kg	0.6	0.6	0.9	0.9	0.9
Conformity	-	CE	CE	CE	CE	CE

* 50 mm above element

Accessories

0-60°C thermostat, normally closed 10A	AAWTC10
10-60°C thermostat, change-over contact 10A	AAWTS10
Humidistat RH 35-95%, change-over contact 5A	AAWHS10

ACCESSORIES

FILTERS



Models	Item code	Quantity per pack	Models	Item code	Quantity per pack
EGO04	AAEFP04	5	EGO05	C15002900	5
EGO06	AAEFP06	5	DEK04	C15000171	5
EGO08-10	AAEFP10	5	DEK08	C15000173	5
EGO12-16-20	C15000163	5	DEK12-15-20	AADFP12	5
EGO30-40	C15000183	5	DEK30-40	AADFP30	5
EGO60	C15000175	5	SKY10-15-20	C15000181	5
EGO80-A0	C15000188	5			

AAEFP/AADFP

PU foam filter for air conditioners

texa industries air conditioners are designed not to require maintenance and are supplied without filters for the external air intake. However, when the ambient air is particularly contaminated by oily aerosols or particles, users can choose to insert a filter in the space provided at the rear of the intake grille. These filters are made from an alveolar polyurethane foam with highly stable mechanical and chemical properties.

ACCESSORIES

FILTERS



Models	Item code	Quantity per pack	Models	Item code	Quantity per pack
EGO04	AAEFM04	1	EGO05	C15002497	1
EGO06	AAEFM06	5	DEK04	C15000172	1
EGO08-10	AAEFM10	1	DEK08	C15000174	1
EGO12-16-20	C15000164	1	DEK12-15-20	AADFM12	1
EGO30-40	C15000185	1	DEK30-40	AADFM30	1
EGO60	C15000176	1	SKY10-15-20	C15000182	1
EGO80-A0	C15000189	1			

AAEFM/AADFM

Reusable air filters for air conditioners

In extreme environmental conditions, the air conditioners can be fitted with metal air filters. They provide less efficient filtration than the PU foam filters, but have the advantage that they are regenerable. They can be cleaned with degreaser and reused as many times as the user wishes. They are made from an aluminium mesh.

ACCESSORIES

FILTERS



Models	Item code	Quantity per pack
FAN08-FIL08	AAFFN08	10
FAN12-FIL12	AAFFN12	10
FAN23-FAN25-FAN28-FIL25	AAFFN25	10
FAN35-FAN39-FIL35	AAFFN35	10

AAFFN

Replacement fabric filters for FAN units

These are the standard fabric filters for the FAN units. To keep the performance of these fan units as high as possible, it is necessary to regularly check the level of clogging of the fabric filters, replacing them with new ones when necessary. The fabric filters are made from self-extinguishing synthetic fibres, with a tight weave and with progressive filtration power. The filtration efficiency can reach 91%. Level of filtration EU4.

ACCESSORIES

FILTERS



Models	Item code	Quantity per pack
FAN08-FIL08	AAFFH08	10
FAN12-FIL12	AAFFH12	10
FAN23-FAN25-FAN28-FIL25	AAFFH25	10
FAN35-FAN39-FIL35	AAFFH35	10

AAFFH

High-efficiency fabric filters

These high-efficiency fabric filters are used for environments with fine dust. Using these fabric filters increases the degree of protection of the fan units, however the air flow rate is reduced from the nominal capacity. The filtration efficiency can reach 97%. Level of filtration EU5.

ACCESSORIES

THERMOSTAT



Features	UoM	AAWTC10
Field of regulation	°C	0-60
Activation differential	K	7
Contact	-	NC
Contact capacity with resistive load	A	10
Max voltage	V	250 AC
Dimensions HxWxD	mm	60x33x35
Sensitive element	-	Bimetallic
Electrical connection	-	2-pole terminal board (2.5 mm ²)
Operating temperature limit	°C	-45+80
IP rating EN60529	-	IP20
Clip installation for DIN rail	mm	35
Weight	g	40
Conformity	-	CE

Accessories		
Pack of 5 x device installation accessories for cabinets	-	AAWFT10

AAWTC10

Compact thermostat, fast snap-on installation, with a wide field of regulation. It has a normally closed contact and is used primarily for controlling anti-condensate heaters.

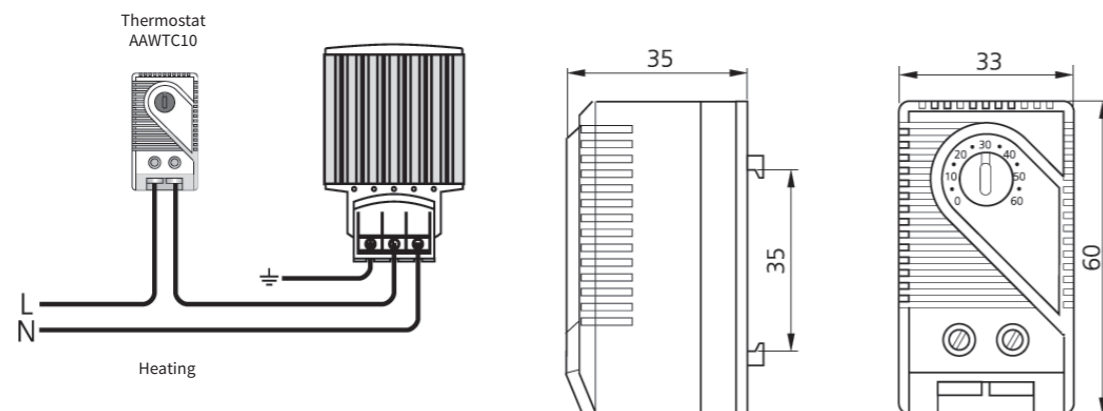

ACCESSORIES

THERMOSTAT



Features	UoM	AAFTO12
Field of regulation	°C	0-60
Activation differential	K	7
Contact	-	NO
Contact capacity with resistive load	A	10
Max voltage	V	250 AC
Dimensions HxWxD	mm	60x33x35
Sensitive element	-	Bimetallic
Electrical connection	-	2-pole terminal board (2.5 mm ²)
Operating temperature limit	°C	-45+80
IP rating EN60529	-	IP20
Clip installation for DIN rail	mm	35
Weight	g	40
Conformity	-	CE

Accessories		
Pack of 5 x device installation accessories for cabinets	-	AAWFT10

AAFTO12

Compact thermostat, fast snap-on installation, with a wide field of regulation. It has a normally open contact and is used primarily for controlling fans, heat exchangers or as a maximum temperature signal.

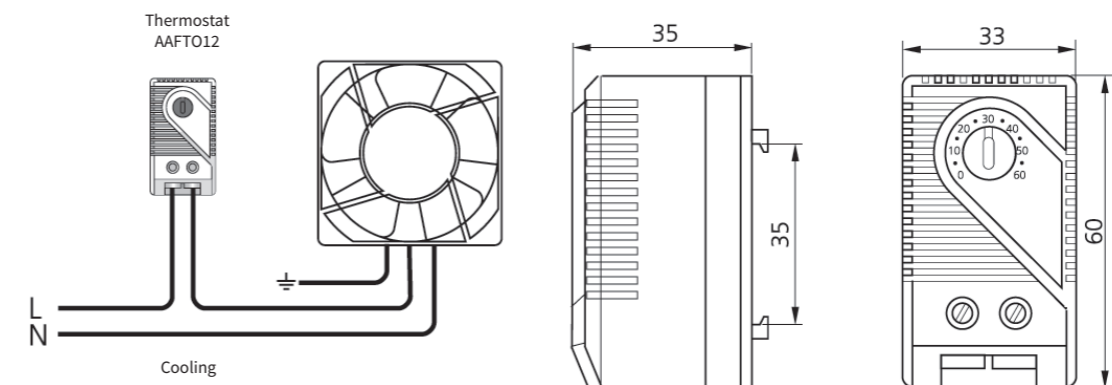

ACCESSORIES

THERMOSTAT



Features	UoM	AAWTS10
Field of regulation	°C	0-60
Activation differential	K	4.0
Contact	-	Change-over
Contact capacity with resistive load	A	10
Max voltage	V	240 AC
Dimensions HxWxD	mm	64x38x51
Sensitive element	-	Bimetallic
Electrical connection	-	3-pole terminal board (2.5 mm ²)
Operating temperature limit	°C	-20+80
IP rating EN60529	-	IP20
Clip installation for DIN rail	mm	35
Weight	g	50
Conformity	-	CE

Accessories		
Pack of 5 x device installation accessories for cabinets	-	AAWFT10

AAWTS10

Thermostat

Thermostat with high current capacity change-over contact

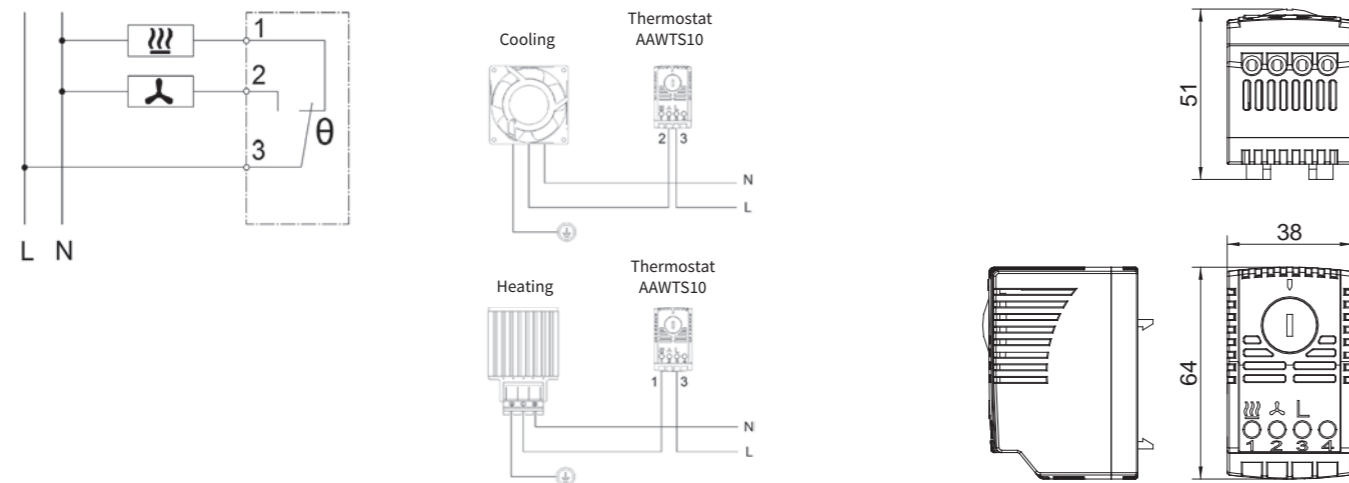

ACCESSORIES

HUMIDISTAT



Features	UoM	AAWHS10
Operating temperature	°C	0-60
Field of regulation	%RH	35-95
Activation differential	%RH	4
Contact	-	Change-over
Contact capacity with resistive load	A	5
Max voltage	V	250 AC
Dimensions HxWxD	mm	67x50x38
Max permissible air speed	m/s	15
Electrical connection	-	3-pole terminal board (2.5 mm ²)
Operating temperature limit	°C	0+60
IP rating EN60529	-	IP20
Clip installation for DIN rail	mm	35
Weight	g	60
Conformity	-	CE

Accessories		
Pack of 5 x device installation accessories for cabinets	-	AAWFT10

AAWHS10

Humidistat

Humidistat which allows the formation of condensation to be prevented, protecting the inside of the cabinet from the resulting inevitable damage. Used to control anti-condensate heaters or dehumidifiers. Features a change-over contact with high switching power.

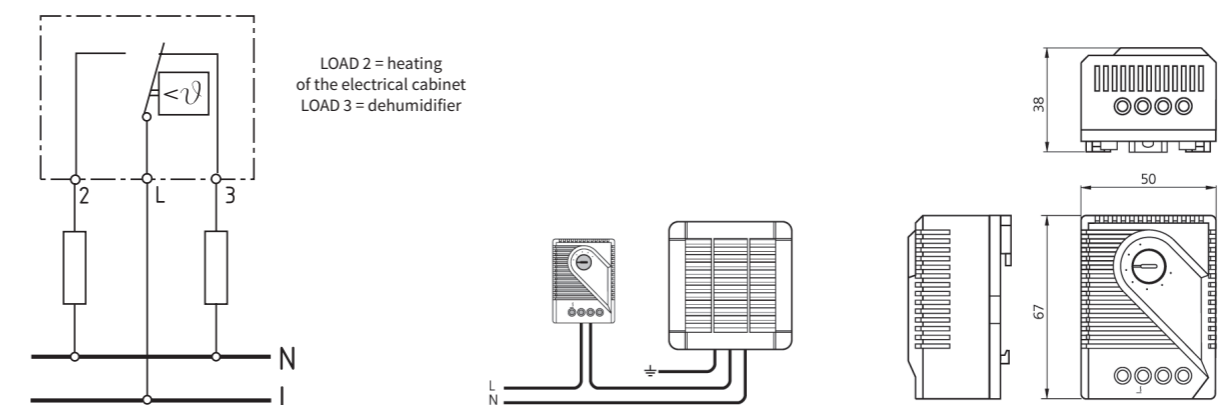

ACCESSORIES

TWINNED THERMOSTAT



Features	UoM	C16000385
Field of regulation	°C	0+60/0+60
Contact	-	NC/NO
Contact capacity with resistive load	A	7
Max voltage	V	250 AC
Dimensions HxWxD	mm	67x50x46
Sensitive element	-	Bimetallic
Electrical connection	-	4-pole terminal board (2.5 mm ²)
Operating temperature limit	°C	-45+80
IP rating EN60529	-	IP20
Clip installation for DIN rail	mm	35
Weight	g	90
Conformity	-	CE

Accessories

Pack of 5 x device installation accessories for cabinets	-	AAWFT10
--	---	---------



C16000385

Twinned thermostat

Two thermostats in a single housing:

- A thermostat with normally closed contact for regulating heating devices.
- A thermostat with normally open contact for regulating fans with filter or heat exchangers.

A version with two normally open contacts is also available

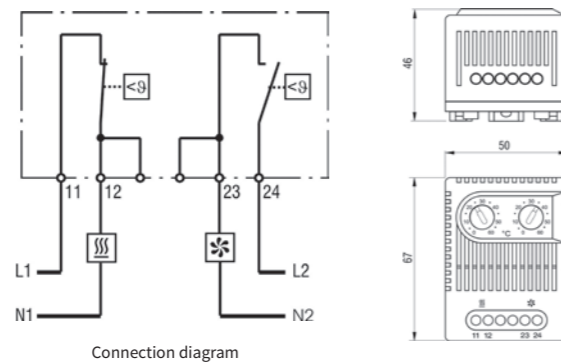

ACCESSORIES

SUPPORT



Features	UoM	AAWFT10
Dimensions HxWxD	mm	38x43x14
Temperature limits	°C	-45+70
Weight	g	12
Quantity per pack	-	5

AAWFT10

Device installation accessory for panels

Plastic accessory for installing thermostats or other small devices inside electrical cabinets. It is easily applied using the adhesive strip with strong anti-ageing properties, which is able to support a continuous load of up to 500 g. It can also be used to install DIN rails.

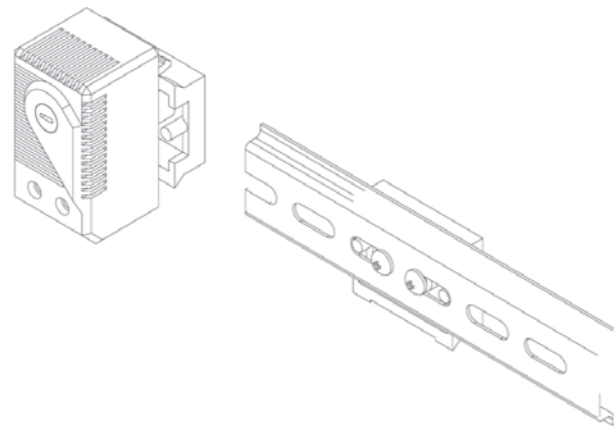

ACCESSORIES

THERMOSTAT



Features	UoM	C1600002
Field of regulation	°C	20-46
Activation differential	K	4.5
Contact capacity with resistive load	A	2.5 - 250V
Dimensions HxWxD	mm	43.5x38x34
Sensitive element	-	Gas bulb
Electrical connection	-	6.3x0.8mm Fastons

C1600002

Thermostat

Thermostat for temperature regulation, with adjustable range of operation between 20 and 46°C. The temperature is read using a gas bulb.

ACCESSORIES

SOLENOID VALVES



Features	UoM	C15000119	C15000120	C15000777
Operating temperature (fluid)	°C	1-60	1-60	1-60
Water flow rate (Δp 1 bar)*	l/min	90	400	90
Max pressure	bar	15	15	15
Connection type	"	G 1/2	G 3/4	G 3/8

* Δp = differential pressure value

C15000119/120/777

Solenoid Valves

Two-way servo-actuated solenoid valves with NBR membrane seal and brass body. Normally closed, they regulate the passage of water.

ACCESSORIES

LEVEL INDICATOR



Features	UoM	C16000140
Max temperature	°C	105
Max pressure	bar	6
Contact	-	NO
Contact rating	A	0.5
Max voltage	V	300
Dimensions	mm	L50 Ø25
Thread	"	G 1/8
Electrical connection	-	Cable L = 1m
IP rating EN60529	-	IP65

C16000140

Level Indicator

Indicator for checking the level of liquids. As the float rises, it magnetically moves an NO contact hermetically sealed inside the guide rod. The magnet is located inside the float and does not come into contact with the liquid.

ACCESSORIES

LED LIGHT



Features	UoM	AALGT10
Power supply	V - Hz	100-240 V AC, 50/60Hz (min. 90 V AC, max. 265 V AC)
Power draw	W	Max. 5
Luminous flux	Lm	290 Lm at 120° (corresponding to 870 Lm at 360° or 75W for an incandescent bulb)
Light bulb	-	LED, angle of irradiation 120°
Lifetime	h	60,000 h at +20°C (+68 °F)
Connection	-	Two-pin locking plug AC: max. 2,5 A/240 V AC, colour: white
Fastening	-	Magnetic fastening
Housing	-	Plastic, transparent
Dimensions	mm	351x34x32
Weight	g	200
Ambient operating temperature	°C - °F	-30°C - +60°C (-22°F - +140°F)
Ambient storage temperature	°C - °F	-40°C - +85°C (-40°F - +185°F)
Ambient operating/ storage humidity	%RH	max. 90% RH (non-condensing)
Protection class/ IP	rating	IP20/II (double insulated)

AALGT10

LED light with magnetic fastening

The AALGT10 range of lights can be used in all types of cabinets or panels, even where space is extremely limited. The magnetic fastening, the integrated power supply and the locking input and output plugs make installation quick, flexible and safe. Up to 10 lights can be connected in series.

LED technology guarantees a very long lamp lifetime.



Female plug
For power supply cable.



Male plug
Only for connecting multiple lights in series (max 10).

LED light
AALGT10

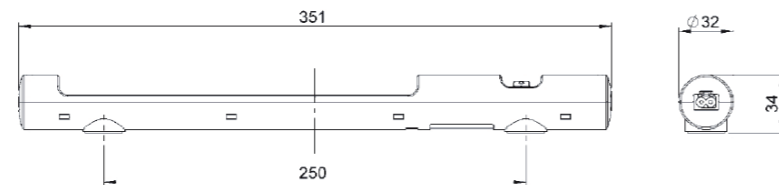

PLANT 2



HEADQUARTERS AND PLANT 1

ACCESSORIES

EGO version "0" range for semi-recessed installation

EGO04

Dimensions

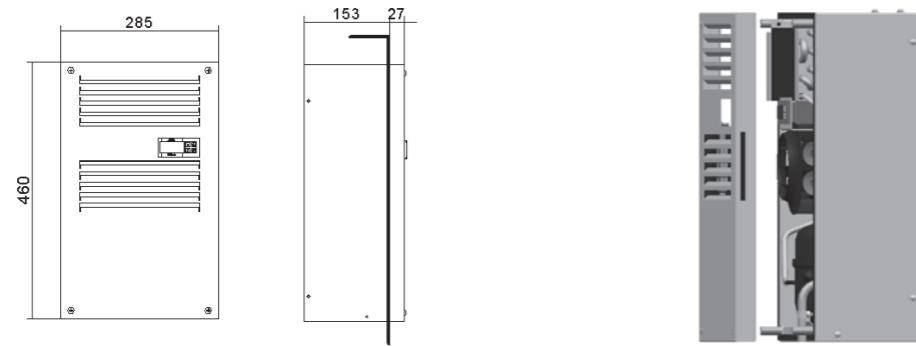

EGO06

Dimensions

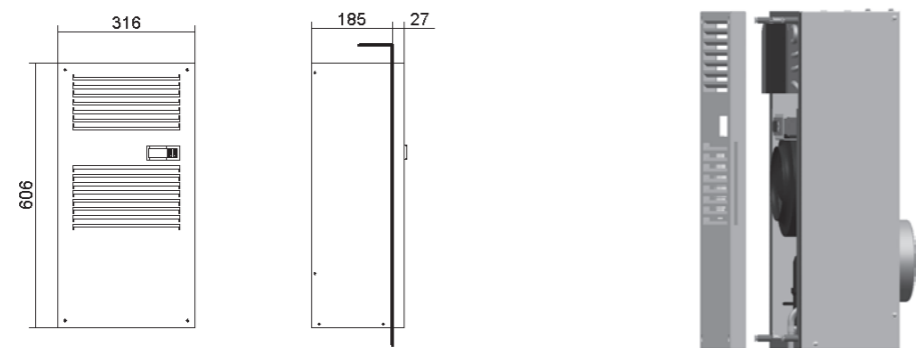

EGO08-10

Dimensions

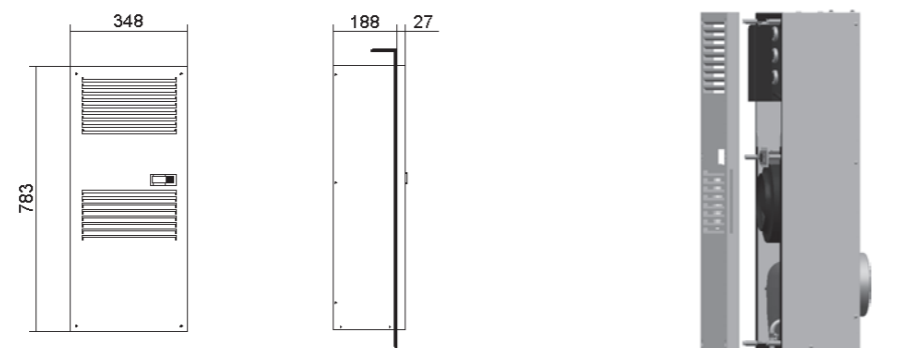

ACCESSORIES

EGO version "0" range for semi-recessed installation

EGO12-16-20

Dimensions

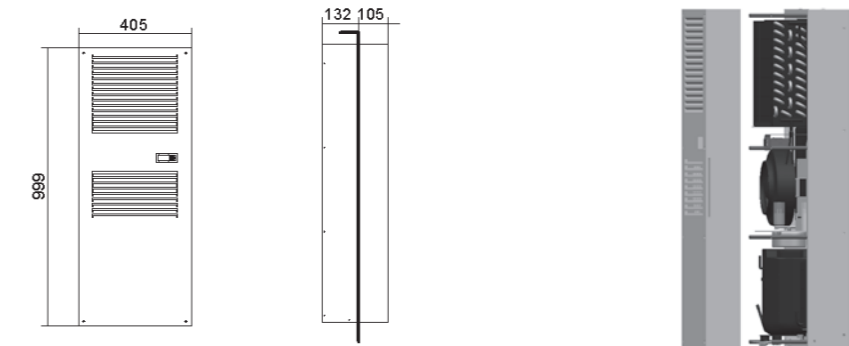

EGO30-40

Dimensions

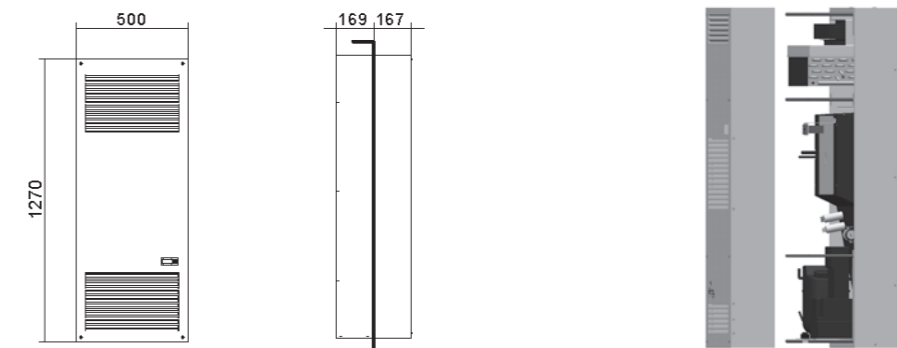



REFRIGERATION RANGE



AT THE HEART OF INNOVATION

There are numerous reasons to choose a **texa industries** cooling system

An attention to detail, a huge range of optional accessories and impressive reliability are the key characteristics which set **texa industries** industrial chillers apart.

ENERGY EFFICIENCY

A polished design for the thermodynamic system and the liquid circuit, combined with the use of next-generation components make our products extremely efficient, with low energy consumption.

CATAPHORESIS TREATMENT

In all particularly demanding industrial applications, in which the maximum protection is required for the components most subject to wear, we offer specific treatments able to offer extended lifetimes.

COOLING PRECISION

Very high precision of the coolant temperature, with setpoint precision down to +/- 0.5 °C.

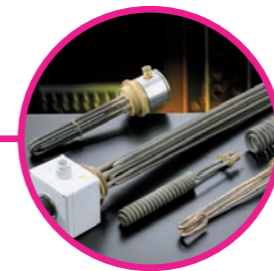
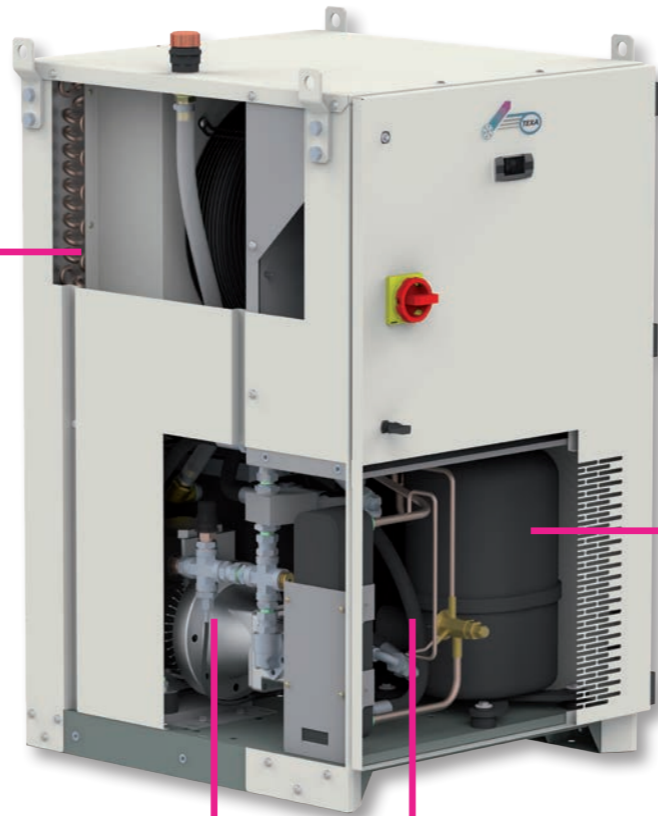
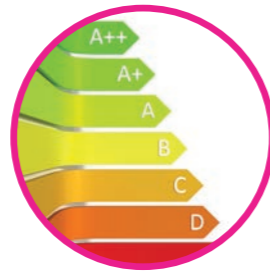

OUTDOOR KIT

There are various kits available as standard which allow chillers to perform even in outdoor conditions with negative ambient temperatures down to -20 °C.

TROPICALISED CHILLERS

Higher performance fans, insulation of the liquid circuit, the highest quality electrical components and wiring covered in neoprene rubber make **texa industries** industrial chillers able to operate at ambient temperatures of up to +55 °C.

NEGATIVE TEMPERATURES

Where temperatures of the cooling medium of as low as -30 °C are required (with 50% glycol), we offer a specific range of chillers borne from our experience in the food and industrial sectors.

PRE-HEATING ELEMENTS

Available on all models, pre-heating elements offer maximum coolant efficiency, ensuring it is always at the correct temperature to guarantee the safety of the system.

LIQUID CIRCUITS (STAINLESS STEEL AND BRASS)

All the liquid circuits of our industrial chillers are equipped as standard with pumps, unions and collection tanks in materials not subject to corrosion, primarily stainless steel and brass. This allows us to guarantee the maximum cleanliness and protection of your cooling circuits.



RECOGNISED COMPONENTS



The possibility to design and manufacture chillers equipped with the best components which meet the safety requirements of the North American market.



MODBUS COMMUNICATION

Remote management via Modbus offered as an option on our entire range of industrial chillers. From simple application to Industry 4.0.



MAXIMUM ERGONOMICS

Putting people at the centre of our products. We make all components requiring an interface with the operator/customer easy to use.



SIMPLE AND COMPACT LAYOUT

Our experience in the field in contact with our customers allows us to create chillers with a simple yet compact layout, with easy access to all main components via removable side panels.



MULTI-COMPRESSOR AND MULTI-CIRCUIT

Special chillers for any type of process fluid (water-Oil) with redundant Multi-Compressor and Multi-Circuit technology for cooling different machines at different temperatures, all enclosed inside a single chiller.

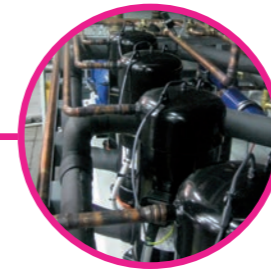

SAVE THE OZONE LAYER

Our company philosophy requires us to design and manufacture refrigeration systems in full compliance with international regulations, and most importantly with respect for the environment in which we live – Save The Ozone Layer!

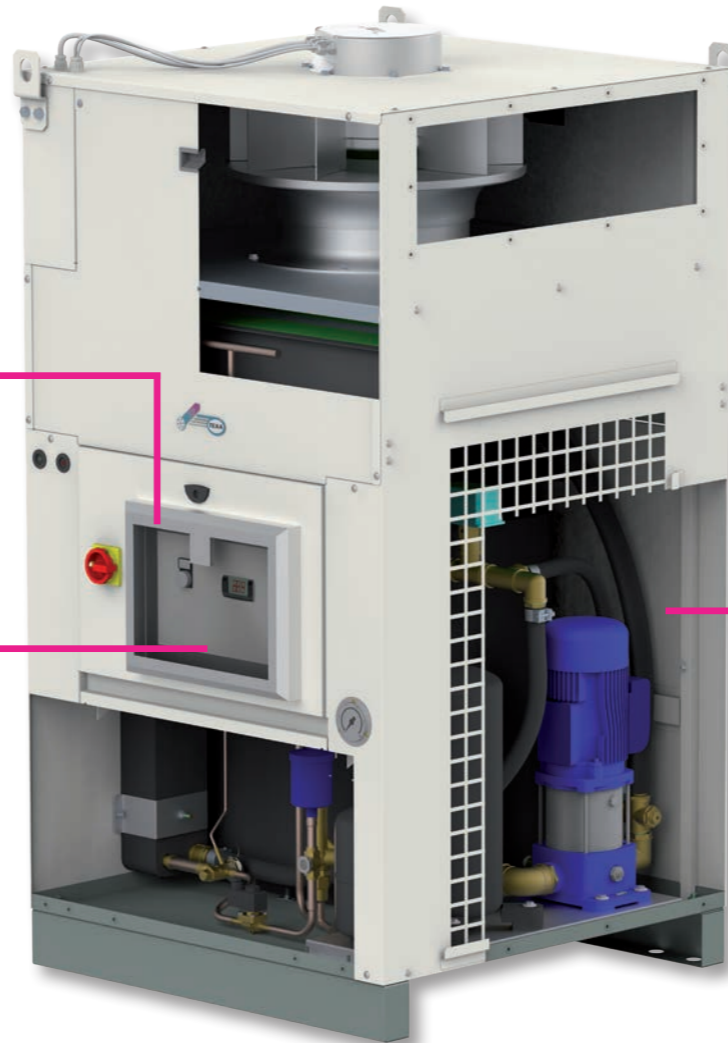

ITEM CODE FORMATION

POSITION	1-3	4-5	6	7	8	9	10	11-15
CHILLER CODING	TCW	08	N	B	S	B	C	00000

1	2	3	Machine type
T	C	W	Air-cooled water chillers
C	C	W	Water chillers with centrifugal fans
T	W	W	Water-cooled water chillers
L	C	W	Low-temperature fluid chillers
C	L	W	Low-temperature fluid chillers with centrifugal fans
L	W	W	Water-cooled low-temperature fluid chillers
T	C	O	Air-cooled oil chillers
C	C	O	Oil chillers with centrifugal fans
T	W	O	Water-cooled oil chillers
T	C	U	Air-cooled dirty fluid chillers
C	C	U	Dirty fluid chillers with centrifugal fans
T	W	U	Water-cooled dirty fluid chillers
T	C	I	Air-cooled immersion coil chillers
C	C	I	Immersion coil chillers with centrifugal fans
T	W	I	Water-cooled immersion coil chillers
S	W	W	Water-water heat exchangers
S	W	O	Water-oil heat exchangers
S	A	W	Water-air heat exchanger
S	A	O	Oil-air heat exchanger

Specific versions
TCW machine version
TCW machine version
LCW machine version
LCW machine version
TCO machine version
TCO machine version
TCU machine version
TCU machine version
TCI machine version
TCI machine version
Not present in catalogue / on request
Not present in catalogue / on request
SAW machine version

POSITION 1-3

4	5	Cooling capacity
-	-	

POSITION 4-5

6	Liquid or dimensional configuration
N	With tank and pump
C	With CLOSED PRESSURISED CIRCUIT tank and pump
P	Without tank, with pump
D	Without tank, without pump
F	Chiller - Without tank, with TUBE EVAPORATOR with pump
G	Chiller - Without tank, with TUBE EVAPORATOR and without pump
O	Horizontal (only SAW-SAO)
R	Vertical (only SAW-SAO)

POSITION 6

7	Power supply
A	480V 3~ 60Hz
B	230 V 1~ 50-60 Hz
C	115 V 1~ 50-60 Hz
D	230 V 1~ 50 Hz
E	230 V 1~ 60 Hz
F	230 V 3~ 50-60 Hz
G	400/440 V 2~ 50-60 Hz
H	400/460 V 3~ 50-60 Hz
I	200 V 3~ 60 Hz
J	380 V 3~ 50 Hz
K	400/440 V 3~ 50-60 Hz
L	400 V 3~ 50-60 Hz
M	400 V 3~ 50 Hz
N	460 V 3~ 60 Hz
P	440 V 3~ 60 Hz
Q	230 V 3~ 50 Hz
R	230 V 3~ 60 Hz
S	400 V 3+N~ 50 Hz
T	12V DC
U	24V DC
V	48V DC
Y	380 V 3~ 60 Hz
Z	110/125V AC/DC

POSITION 7

8	Electric pump
S	Standard water pump (3 bar)
H	HIGH-pressure water pump (5 bar)
R	MAXIMUM-pressure water pump (7 bar)
I	Gear oil pump
V	Screw oil pump

POSITION 8

9	Paint/coating
A	RAL 7032 embossed effect
B	RAL 7035 embossed effect (STANDARD)
C	RAL 5015 embossed effect
D	RAL 6011 embossed effect
E	RAL 9005 embossed effect
F	RAL 7032 gloss
G	RAL 1014 gloss
H	RAL 5010 embossed effect
L	RAL 6011 gloss
M	RAL 6027 gloss
N	RAL 9010 gloss
P	RAL 7037 gloss
Q	RAL 7035 gloss
R	RAL 9006 embossed effect
S	RAL 5012 gloss
T	RAL 5012 embossed effect
V	RAL 5019 gloss
X	Special paint/coating
9	Satin stainless-steel framework

POSITION 9

10	Availability
C	Standard catalogue item
X	Non-standard - special order

POSITION 10

11	12	13	14	15	Optional accessories
-		IFP			Liquid circuit insulation + 2 metres of power supply cable + FP
0					No optional accessories
1		BA			Automatic bypass
2		BGP			Heat bypass with PID regulat. for Temp. precis. +/- 0.5 K
3		BGC			Heat bypass for temperature precision +/- 1 K
4		BM			Manual bypass
5		HS			Harting connector for signals
6		HP			Harting connector for power
7		RCA			Remote control contact with 230V relay
8		RCB			Remote control contact with 24V AC/DC relay
9		CNA			Additional liquid inlet/outlet
A		FW			Mechanical water/oil filter
B		FA			Metal mesh air filter
C		FL			Fluid flow switch
D		TD			Differential fluid temperature management
E		LTW			Low fluid temperature operation to -10°C
F		LTA			Low ambient temperature operation to -10°C
G		HR			Electrical preheating element
H		LE			Electrical level indicator
I		FWS			Mechanical water/oil filter fouled signal
J		RU			Castors (2 with brakes)
K		TPR			Tropicalised version to +55°C
L		FAS			Metal mesh air filter fouled alarm signal
M		OM			Unit built for outdoor operation down to -10 °C ambient temp.
N		VO			External in/out machine cut-off valves
O		AV			Vibration damper supports
P		LS			Hydraulic circuit for Laser (deionised water)
R		AR			Electrical automatic tank filling
S		ISB			Machine submerged installation kit (only with tank)
T		LP			Low pressure switch
U		UL			Parts compliant with UL standards (unit not certified)
V		CTH			Refrigerant circuit CATAPHORESIS treatment
W		OML			Unit built for outdoor operation down to -20 °C ambient temp.
X		FP			Polyurethane air filter
Y		TS			Secondary power supply voltage - 24V DC
Z		TV			Additional temperature or remote display

POSITION 11-15

ITEM CODE FORMATION

POSITION	1-3	4-5	6	7	8	9	10	11	12-15
TEMPERATURE CONTROLLER CODING	TTW	90	D	M	N	S	B	C	0000

1	2	3	Machine type
T	T	W	Temperature controller for water

POSITION 1-3

4	5	Model
9	0	
9	5	

POSITION 4-5

6	Liquid configuration
D	Direct
I	Indirect

POSITION 6

7	Power supply
A	480V 3~ 60Hz
B	230 V 1~ 50-60 Hz
C	115 V 1~ 50-60 Hz
D	230 V 1~ 50 Hz
E	230 V 1~ 60 Hz
F	230 V 3~ 50-60 Hz
G	400/440 V 2~ 50-60 Hz
H	400/460 V 3~ 50-60 Hz
I	200 V 3~ 60 Hz
J	380 V 3~ 50 Hz
K	400/440 V 3~ 50-60 Hz
L	400 V 3~ 50-60 Hz
M	400 V 3~ 50 Hz
N	460 V 3~ 60 Hz
P	440 V 3~ 60 Hz
Q	230 V 3~ 50 Hz
R	230 V 3~ 60 Hz
S	400 V 3+N~ 50 Hz
T	12V DC
U	24V DC
V	48V DC
Y	380 V 3~ 60 Hz
Z	110/125V AC/DC

POSITION 7

8	Heating power
N	Without heating element
3	3 kW heating element
6	6 kW heating element
9	9 kW heating element
A	12 kW heating element
B	Dual temperature controller, 6 kW + 12 kW
C	18 kW heating element
D	24 kW heating element
E	36 kW heating element
F	Triple temperature controller, 18 kW + 9 kW + 9 kW
G	Triple temperature controller, 6 kW + 6 kW + 3 kW
H	Triple temperature controller, 6 kW + 6 kW + 3 kW
I	Dual temperature controller, 6 kW + 3 kW
L	Dual temperature controller, 9 kW + 9 kW

POSITION 8

9	Number of temperature controllers
S	Single
D	Double
T	Triple
Q	Quadruple

POSITION 9

10	Paint/coating
A	RAL 7032 embossed effect
B	RAL 7035 embossed effect (STANDARD)
C	RAL 5015 embossed effect
D	RAL 6011 embossed effect
E	RAL 9005 embossed effect
F	RAL 7032 gloss
G	RAL 1014 gloss
H	RAL 5010 embossed effect
L	RAL 6011 gloss
M	RAL 6027 gloss
N	RAL 9010 gloss
P	RAL 7037 gloss
Q	RAL 7035 gloss
R	RAL 9006 embossed effect
S	RAL 5012 gloss
T	RAL 5012 embossed effect
V	RAL 5019 gloss
X	Special paint/coating
9	Stainless-steel framework

POSITION 10

11	Availability
C	Standard catalogue item
X	Non-catalogue - Special

POSITION 11

12	13	14	15	Optional accessories
0				No optional accessories
J			RU	Castors (two with brakes)
N			VO	External in/out machine cut-off valves (4 pcs.)

POSITION 12-15

TCW

Industrial water chillers

The largest range of water chillers: precise, reliable and compact. **texa industries'** answer to the main industrial process cooling requirements.



TCW08-19 Minichiller

Industrial water chillers

COOLING CAPACITY

900-1100 - 1600-1900 - 2200-2550 W



AXIAL FAN

Axial fan, complete with electrical protection and safety grille.

LIQUID CIRCUIT

Liquid circuit composed entirely of non-ferrous material in contact with the liquid to prevent contamination. Standard liquid circuit with open reservoir and pump, protective flow switch, pressure gauge, regulation sensor. Peripheral electric pump with 4.5 bar available head. Plastic storage tank complete with drain valve and visual level indicator.

ELECTRICAL PANEL

With main breaker, fused motor protection with LED visual fault indicator, voltage presence light.

MANAGEMENT AND CONTROL

The TX110 control unit manages the chiller's operation, providing warnings including high/low temperature alarms and a general serious fault alarm, with the display indicating if this refers to the refrigeration or liquid circuit. An on-off contact allows the machine to be switched on remotely. Control disconnect switch for switching on the machine.

PAINT/COATING

Standard colour: RAL 7035 textured.

MAIN ACCESSORIES (ref. page 189)

BA - Mechanical bypass valve protecting the pump

BM - Manual bypass valve protecting the pump

LE - Level indicator

LTA - Operation at low ambient temperatures

FP - Polyurethane air filter

RU - Castors

TD - Differential fluid temperature management (two sensors)

BGC - Hot gas bypass for +/- 1 K temperature precision

LS - Liquid circuit for laser application

- HIGH-pressure pump

- Satin AISI 304 stainless steel framework

STRUCTURE

In powder-coated steel sheet, RAL 7035 textured finish. Easily removed panel

COMPRESSOR

Hermetic reciprocating compressor, cooled by the refrigerant, complete with thermal cut-out.

REFRIGERATION CIRCUIT

Complete with charging port, drier filter, expansion valve, high- and low-pressure safety pressure switch, R134a refrigerant.

EVAPORATOR

Brazed stainless-steel plate model.

AIR CONDENSER

Finned high-efficiency copper tube condensing coil, complete with safety grille.

Dimensions

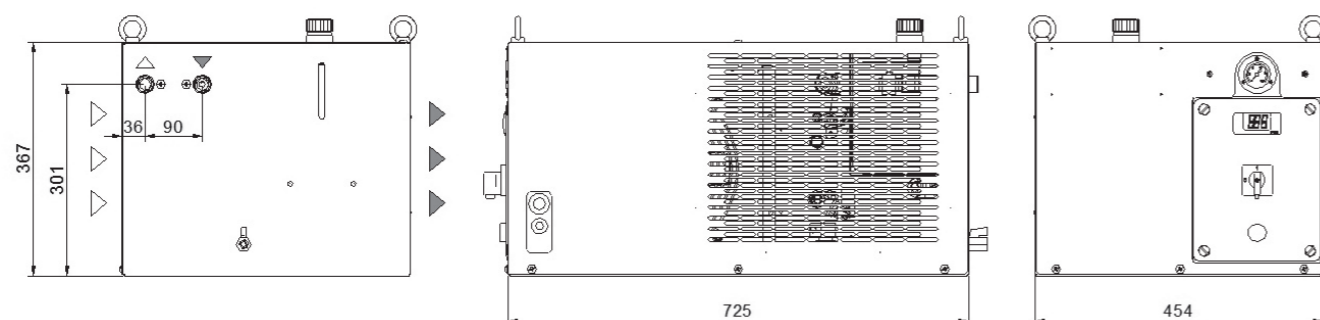

Model		TCW08		TCW12		TCW19	
		50Hz	60Hz	50Hz	60Hz	50Hz	60Hz
Rated Cooling Capacity*	W	900	1100	1600	1900	2200	2550
Ambient temperature operating limits	°C	+15 - +45					
Settable fluid temperature range	°C	+8 - +25					
Fluid type		Water					
Temperature precision	K	+/-2					
Refrigerant gas	HFC	R134a					
Power supply							
Supply voltage	V ph Hz	230V (+/-10%) 1ph 50/60Hz					
Secondary supply voltage	V	230					
Digital thermostat		TX110					
Compressor							
Compressor type		Reciprocating					
Quantity - Number of circuits	no.	1 - 1					
Max. power draw	kW	0.5	0.6	0.7	1.1	1	1.15
Max. current draw	A	2.8	3.1	4.1	4.3	6	6.5
Axial Fan							
Fan type		Axial					
Quantity	no.	1		1		1	
Air flow rate	m ³ /h	1000		1000		1000	
Max. power draw	W	150	190	150	190	150	190
Max. current draw	A	0.66	0.85	0.66	0.85	0.66	0.85
Standard Pump							
Pump type		Peripheral					
Quantity	no.	1		1		1	
Nominal/max fluid flow rate	l/min	3.0 - 20.0		5.0 - 20.0		6.5 - 20.0	
Nominal available head	bar	5.4	7.6	5.2	6.7	4.6	6
Available power draw	kW	0.75	0.75	0.75	0.75	0.75	0.75
Max. current draw	A	2.8	3.7	2.8	3.7	2.8	3.7
High-Pressure Pump (optional)							
Pump type		Peripheral					
Quantity	no.	1		1		1	
Nominal available head	bar	6.5	8.4	6	7.9	5.8	7.6
Max. power draw	kW	1.29	1.29	1.29	1.29	1.29	1.29
Max. current draw	A	5	6	5	6	5	6
Storage tank capacity	l	10					
IN/OUT liquid connections	mm	1/2"					
Net weight (approximate)***	kg	52		54		55	
Width	mm	725					
Depth	mm	454					
Height	mm	367					
Sound pressure level**	dB(A)	56		56		56	
IP rating	IP	44					

* Data relating to operation under the following conditions: intake/outlet temperature 20/15°C, water without glycol, ambient temperature 32°C. Cooling power refers to the evaporator unit.

** Sound pressure level at 50Hz, measured in a free hemispherical field at a distance of 1 m from the machine and 1.5 metres from the ground, per ISO 3746.

*** Weight includes pallets and packaging (where provided for), with refrigerant charge, storage tank empty, axial fans.

**** The electrical data refer to $\cos \phi = 0.8$.

Correction factors for calculating the cooling power

Water outlet temperature	Fw	°C									
			8	10	15	20	25				
	factor		0.86	0.92	1	1.05	1.12				
Ambient Temperature	Fa	°C									
			15	20	25	32	35	40	45		
	factor		1.16	1.1	1.05	1	0.97	0.91	0.84		
Percentage glycol by weight	Fg	%									
			0	10	15	20	25	30	35	40	
	factor		1	0.99	0.98	0.97	0.96	0.94	0.92	0.89	

Cooling power = Nominal cooling power x Fw x Fa x Fg

TCW31-41 Minichiller HP

Industrial water chillers

COOLING CAPACITY

3000-3450 - 3900-4450 W



AXIAL FAN

Axial fan, complete with electrical thermal protection and safety grille.

LIQUID CIRCUIT

Liquid circuit composed entirely of non-ferrous material in contact with the liquid to prevent contamination. Standard liquid circuit with open reservoir and pump, protective flow switch, pressure gauge, regulation sensor. Peripheral electric pump with 4.5 bar available head. Plastic storage tank complete with drain valve and visual level indicator.

ELECTRICAL PANEL

With main breaker, fused motor protection with LED visual fault indicator, voltage presence light.

MANAGEMENT AND CONTROL

The TX110 control unit manages the chiller's operation, providing warnings including high/low temperature alarms and a general serious fault alarm, with the display indicating if this refers to the refrigeration or liquid circuit. An on-off contact allows the machine to be switched on remotely. Control disconnect switch for switching on the machine.

PAINT/COATING

Standard colour: RAL 7035 textured.

STRUCTURE

In powder-coated steel sheet, RAL 7035 textured finish. Easily removed panel

COMPRESSOR

Hermetic reciprocating compressor, cooled by the refrigerant, complete with thermal cut-out.

REFRIGERATION CIRCUIT

Complete with charging port, drier filter, expansion valve, high- and low-pressure safety pressure switch, thermostatic valve. R134a refrigerant.

EVAPORATOR

Brazed stainless-steel plate model.

AIR CONDENSER

Finned high-efficiency copper tube condensing coil, complete with safety grille.

MAIN ACCESSORIES (ref. page 189)

- BA - Mechanical bypass valve protecting the pump
- BM - Manual bypass valve protecting the pump
- LE - Electrical level indicator
- LTA - Operation at low ambient temperatures
- FP - Polyurethane air filter
- RU - Castors
- TD - Differential fluid temperature management (two sensors)
- BGC - Hot gas bypass for +/- 1 K temperature precision
- HIGH-pressure pump
- Non-standard paint/coating
- Satin AISI 304 stainless steel framework

Dimensions

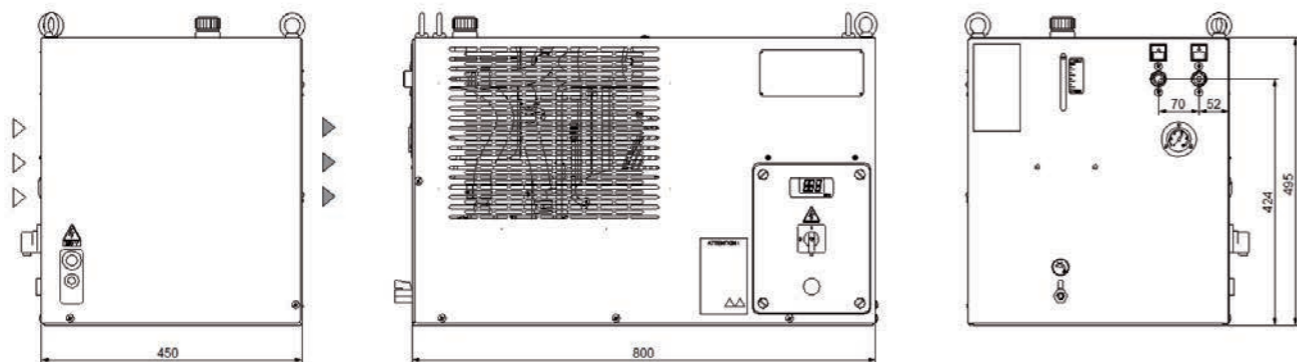

Model		TCW31		TCW41	
		50Hz	60Hz	50Hz	60Hz
Rated Cooling Capacity*	W	3000	3450	3900	4450
Ambient temperature operating limits	°C	+15 - +45			
Settable fluid temperature range	°C	+8 - +25			
Fluid type		Water			
Temperature precision	K	+/-2			
Refrigerant gas	HFC	R134a			
Power supply					
Supply voltage	V ph Hz	230V (+/-10%) 1ph 50/60Hz			
Secondary supply voltage	V	230			
Digital thermostat		TX110			
Compressor					
Compressor type		Reciprocating			
Quantity - Number of circuits	no.	1 - 1			
Max. power draw	kW	1.15	1.5	1.6	1.92
Max. current draw	A	6.1	8.1	7.2	8.4
Axial Fan					
Compressor type		Axial			
Quantity	no.	1		1	
Air flow rate	m ³ /h	2300	2650	2300	2650
Max. power draw	W	180	250	180	250
Max. current draw	A	0.81	1.1	0.81	1.1
Standard Pump					
Pump type		Peripheral			
Quantity	no.	1		1	
Nominal/max fluid flow rate	l/min	6.5 - 20		11 - 20	
Nominal available head	bar	3.7	5.1	2.8	4.0
Available power draw	kW	0.75	0.75	0.75	0.75
Max. current draw	A	2.8	3.7	2.8	3.7
High-Pressure Pump (optional)					
Pump type		Peripheral			
Quantity	no.	1		1	
Nominal available head	bar	4.6	7.2	4.9	6.6
Max. power draw	kW	1.29	1.29	1.29	1.29
Max. current draw	A	5	6	5	6
Storage tank capacity	l	10			
IN/OUT liquid connections	mm	1/2"			
Net weight (approximate)***	kg	74		75	
Width	mm	800			
Depth	mm	450			
Height	mm	495			
Sound pressure level**	dB(A)	57	60	57	60
IP rating	IP	44			

* Data relating to operation under the following conditions: intake/outlet temperature 20/15°C, water without glycol, ambient temperature 32°C. Cooling power refers to the evaporator unit.

** Sound pressure level at 50Hz, measured in a free hemispherical field at a distance of 1 m from the machine and 1.5 metres from the ground, per ISO 3746.

*** Weight includes pallets and packaging (where provided for), with refrigerant charge, storage tank empty, axial fans.

**** The electrical data refer to $\cos \phi = 0.8$.

Correction factors for calculating the cooling power

Water outlet temperature	Fw	°C									
			8	10	15	20	25				
	factor		0.86	0.92	1	1.05	1.12				
Ambient Temperature	Fa	°C									
			15	20	25	32	35	40	45		
	factor		1.16	1.1	1.05	1	0.97	0.91	0.84		
Percentage glycol by weight	Fg	%									
			0	10	15	20	25	30	35	40	
	factor		1	0.99	0.98	0.97	0.96	0.94	0.92	0.89	

Cooling power = Nominal cooling power x Fw x Fa x Fg

TCW15-36 Size 1

Industrial water chillers

COOLING CAPACITY

1600-1900 - 2200-2550 - 3300-3900 W



AXIAL FAN

Axial fan, complete with thermal cut-out and safety grille.

LIQUID CIRCUIT

Liquid circuit composed entirely of non-ferrous material in contact with the liquid to prevent contamination. Peripheral electric pump, stainless-steel storage tank complete with drain valve and visual level indicator, 0-10 bar pressure gauge, protective flow switch, regulation sensor.

ELECTRICAL PANEL

With main disconnect switch, fused motor protection.

MANAGEMENT AND CONTROL

The TX110 control unit manages the chiller's operation, providing warnings including high/low temperature alarms and a general serious fault alarm, with the display indicating if this refers to the refrigeration or liquid circuit. An on-off contact allows the machine to be switched on remotely. Control disconnect switch for switching on the machine.

PAINT/COATING

Standard colour: RAL 7035 textured.

STRUCTURE

In powder-coated steel sheet, RAL 7035 textured finish. Easily removed panels

COMPRESSOR

Hermetic reciprocating compressor, cooled by the refrigerant, complete with electrical protection.

REFRIGERATION CIRCUIT

Complete with charging port, drier filter, thermostatic valve, high- and low-pressure pressure switch, R134a refrigerant.

EVAPORATOR

Brazed stainless-steel plate model.

AIR CONDENSER

Finned high-efficiency copper tube condensing coil, complete with safety grille.

MAIN ACCESSORIES (ref. page 189)

- BA - Mechanical bypass valve protecting the pump
- HR - Fluid heating element
- LE - Electrical level indicator
- LTA - Operation at low ambient temperatures
- FP - Polyurethane air filter
- RU - Castors
- TD - Differential fluid temperature management (two sensors)
- BGC - Hot gas bypass for +/- 1 K temperature precision
- LS - Liquid circuit for laser application
- HIGH-pressure pump version "H" - 5 bar, version "R" - 7 bar.
- Non-standard paint/coating
- Satin AISI 304 stainless steel framework.

Dimensions

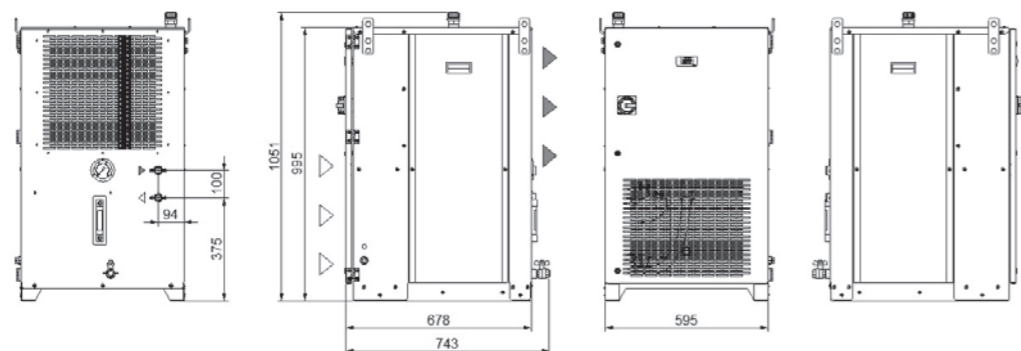

Model		TCW15		TCW22		TCW36	
		50Hz	60Hz	50Hz	60Hz	50Hz	60Hz
Rated Cooling Capacity*	W	1600	1900	2200	2550	3300	3900
Ambient temperature operating limits	°C	+15 - +45					
Settable fluid temperature range	°C	+8 - +25					
Fluid type		Water					
Temperature precision	K	+/-2					
Refrigerant gas	HFC	R134a					
Power supply							
Supply voltage	V ph Hz	230V (+/-10%) 1ph 50/60Hz					
Secondary supply voltage	V	230					
Digital thermostat		TX110					
Compressor							
Compressor type		Reciprocating					
Quantity - Number of circuits	no.	1 - 1					
Max. power draw	kW	1.03	1.06	1.15	1.5	1.73	2.2
Max. current draw	A	5.6	5.8	6.1	8.1	9.4	12
Axial Fan							
Fan type		Axial					
Quantity	no.	1		1		1	
Air flow rate	m³/h	2300 - 2650		2300 - 2650		2300 - 2650	
Max. power draw	kW	0.18	0.25	0.18	0.25	0.18	0.25
Max. current draw	A	0.81	1.1	0.81	1.1	0.81	1.1
Centrifugal Fan (optional)							
Fan type		Centrifugal					
Quantity	no.	1		1		1	
Air flow rate	m³/h	2100 - 2400		2100 - 2400		2100 - 2400	
Available head	Pa	250					
Max. power draw	kW	0.15	0.21	0.15	0.21	0.15	0.21
Max. current draw	A	0.35	0.37	0.35	0.37	0.35	0.37
Standard Pump							
Pump type		Peripheral					
Quantity	no.	1		1		1	
Nominal/max fluid flow rate	l/min	5.0 - 35		7 - 35		9 - 35	
Nominal available head	bar	3.8	4	3.7	4	3.6	4
Max. power draw	kW	1.23		1.23		1.23	
Max. current draw	A	5	6	5	6	5	6
High-Pressure Pump (optional)							
Pump type		Peripheral					
Quantity	no.	1		1		1	
Nominal available head	bar	5 - 6.4		4.8 - 6		4.7 - 5.6	
Max. power draw	kW	1.29		1.29		1.29	
Max. current draw	A	5.5	6.5	5.5	6.5	5.5	6.5
Storage tank capacity	l	30					
IN/OUT liquid connections	inch	3/4"					
Net weight (approximate)***	kg	130		132		132	
Width	mm	595					
Depth	mm	678					
Height	mm	995					
Sound pressure level**	dB(A)	57 - 60		57 - 60		57 - 60	
IP rating	IP	44					

* Data relating to operation under the following conditions: intake/outlet temperature 20/15°C, water without glycol, ambient temperature 32°C. Cooling power refers to the evaporator unit.

** Sound pressure level at 50Hz, measured in a free hemispherical field at a distance of 1 m from the machine and 1.5 metres from the ground, per ISO 3746.

*** Weight includes pallets and packaging (where provided for), with refrigerant charge, storage tank empty, axial fans.

**** The electrical data refer to cos φ = 0.8.

Correction factors for calculating the cooling power

Water outlet temperature	Fw	°C								
			8	10	15	20	25			
	factor		0.86	0.92	1	1.05	1.12			
Ambient Temperature	Fa	°C								
			15	20	25	32	35	40	45	
	factor		1.16	1.1	1.05	1	0.97	0.91	0.84	
Percentage glycol by weight	Fg	%								
			0	10	15	20	25	30	35	40
	factor		1	0.99	0.98	0.97	0.96	0.94	0.92	0.89

$$\text{Cooling power} = \text{Nominal cooling power} \times F_w \times F_a \times F_g$$

TCW22-55 Size 1 Three Phase

Industrial water chillers

COOLING CAPACITY

2200 - 3300 - 4400 - 5300 W



AXIAL FAN

Axial fan, complete with thermal cut-out and safety grille.

LIQUID CIRCUIT

Liquid circuit composed entirely of non-ferrous material in contact with the liquid to prevent contamination. Peripheral electric pump with 3 bar available head, stainless-steel storage tank complete with drain valve and visual level indicator, 0-10 bar pressure gauge, protective flow switch, regulation sensor.

ELECTRICAL PANEL

With main disconnect switch, relay motor protection, phase sequence relays.

MANAGEMENT AND CONTROL

The TX110 control unit manages the chiller's operation, providing warnings including high/low temperature alarms and a general serious fault alarm, with the display indicating if this refers to the refrigeration or liquid circuit. An on-off contact allows the machine to be switched on remotely. Control disconnect switch for switching on the machine.

PAINT/COATING

Standard colour: RAL 7035 textured.

STRUCTURE

In powder-coated steel sheet, RAL 7035 textured finish. Easily removed panels

COMPRESSOR

Hermetic reciprocating compressor, cooled by the refrigerant, complete with thermal cut-out.

REFRIGERATION CIRCUIT

Complete with charging port, drier filter, thermostatic valve, high- and low-pressure pressure switch, R134a refrigerant.

EVAPORATOR

Brazed stainless-steel plate model.

AIR CONDENSER

Finned high-efficiency copper tube condensing coil, complete with safety grille.

MAIN ACCESSORIES (ref. page 189)

- BA - Mechanical bypass valve protecting the pump
- HR - Fluid heating element
- LE - Electrical level indicator
- LTA - Operation at low ambient temperatures
- FP - Polyurethane air filter
- RU - Castors
- TD - Differential fluid temperature management (two sensors)
- BGC - Hot gas bypass for +/- 1 K temperature precision
- LS - Liquid circuit for laser application
- HIGH-pressure pump version "H" - 5 bar, version "R" - 7 bar.
- Non-standard paint/coating
- Satin AISI 304 stainless steel framework

Dimensions

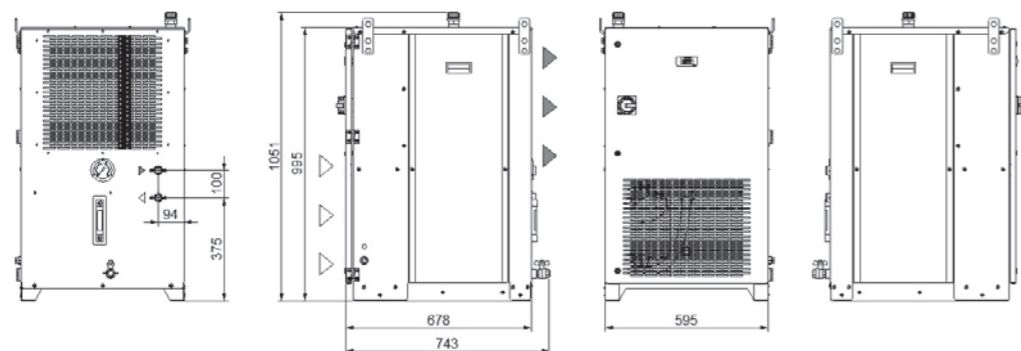

Model		TCW22	TCW36	TCW44	TCW55
Rated Cooling Capacity*	W	2200	3300	4400	5300
Ambient temperature operating limits	°C	+15 - +45			
Settable fluid temperature range	°C	+8 - +25			
Fluid type		Water			
Temperature precision	K	+/-2			
Refrigerant gas	HFC	R134a			
Power supply					
Supply voltage	V ph Hz	400V (+/-10%) 3ph 50Hz			
Secondary supply voltage	V	230 V AC			
Digital thermostat		TX110			
Compressor					
Compressor type		Reciprocating			
Quantity - Number of circuits	no.	1 - 1			
Max. power draw	kW	1.5	1.72	2.32	2.61
Max. current draw	A	2.7	3.1	4.2	4.7
Axial Fan					
Fan type		Axial			
Quantity	no.	1	1	1	1
Air flow rate	m³/h	2300	2300	2050	2050
Max. power draw	kW	0.18	0.18	0.18	0.18
Max. current draw	A	0.81	0.81	0.81	0.81
Centrifugal Fan (optional)					
Fan type		Centrifugal			
Quantity	no.	1	1	1	1
Air flow rate	m³/h	2100 - 2400	2100 - 2400	2100 - 2400	2100 - 2400
Available head	Pa	250		230	
Max. power draw	W	145 - 205	145 - 205	145 - 205	145 - 205
Max. current draw	A	0.35 - 0.37	0.35 - 0.37	0.35 - 0.37	0.35 - 0.37
Standard Pump					
Pump type		Peripheral			
Quantity	no.	1	1	1	1
Nominal/max fluid flow rate	l/min	7 - 40	9 - 40	12 - 40	15 - 40
Nominal available head	bar	3.1	3	2.9	2.7
Max. power draw	kW	0.47	0.47	0.47	0.47
Max. current draw	A	1.12	1.12	1.12	1.12
High-Pressure Pump (optional)					
Pump type		Peripheral			
Quantity	no.	1	1	1	1
Nominal available head	bar	5.2	5	4.8	4.6
Max. power draw	kW	0.68	0.68	0.68	0.68
Max. current draw	A	1.52	1.52	1.52	1.52
Storage tank capacity	l	30			
IN/OUT liquid connections	inch	3/4"			
Net weight (approximate)***	kg	132	132	134	135
Width	mm	595			
Depth	mm	678			
Height	mm	995			
Sound pressure level**	dB(A)	57	57	57	57
IP rating	IP	44			

* Data relating to operation under the following conditions: intake/outlet temperature 20/15°C, water without glycol, ambient temperature 32°C. Cooling power refers to the evaporator unit.

** Sound pressure level, measured in a free hemispherical field at a distance of 1 m from the machine and 1.5 metres from the ground, per ISO 3746.

*** Weight includes pallets and packaging (where provided for), with refrigerant charge, storage tank empty, axial fans.

**** The electrical data refer to cos φ = 0.8.

Correction factors for calculating the cooling power

Water outlet temperature	Fw	°C									
			8	10	15	20	25				
	factor		0.86	0.92	1	1.05	1.12				
Ambient Temperature	Fa	°C									
			15	20	25	32	35	40	45		
	factor		1.16	1.1	1.05	1	0.97	0.91	0.84		
Percentage glycol by weight	Fg	%									
			0	10	15	20	25	30	35	40	
	factor		1	0.99	0.98	0.97	0.96	0.94	0.92	0.89	

Cooling power = Nominal cooling power x Fw x Fa x Fg

TCW56-A0 Size 2

Industrial water chillers

COOLING CAPACITY

6000 - 8100 - 9200 - 10900 W



AIR CONDENSER

Finned high-efficiency copper tube condensing coil, complete with safety grille.

AXIAL FAN

Axial fan, complete with thermal cut-out and safety grille.

LIQUID CIRCUIT

Liquid circuit composed entirely of non-ferrous material in contact with the liquid to prevent contamination. Stainless-steel centrifugal pump with 3 bar available head. Stainless-steel storage tank complete with drain valve, electrical level and visual level indicator, 0-10 bar pressure gauge, protective flow switch, regulation sensor.

ELECTRICAL PANEL

With main disconnect switch, relay motor protection, phase sequence relays.

MANAGEMENT AND CONTROL

The TX200 control unit manages the operation of the chiller and provides complete operator alarm diagnostics. An on-off contact allows the machine to be switched on remotely. Illuminated control selector. Possibility of remote display for machine regulation.

PAINT/COATING

Standard colour: RAL 7035 textured.

MAIN ACCESSORIES (ref. page 189)

BA - Mechanical bypass valve protecting the pump

HR - Fluid heating element

LTA - Operation at low ambient temperatures

FP - Polyurethane air filter

RU - Castors

TD - Differential fluid temperature management (two sensors)

BGC - Hot gas bypass for +/- 1 K temperature precision

LS - Liquid circuit for laser application

- HIGH-pressure pump version "H" - 5 bar, version "R" - 7 bar.

- Non-standard paint/coating

- Satin AISI 304 stainless steel framework

STRUCTURE

In powder-coated steel sheet, RAL 7035 textured finish. Easily removed panels

COMPRESSOR

Hermetic scroll compressor, cooled by the refrigerant, complete with thermal cut-out.

REFRIGERATION CIRCUIT

Complete with charging port, liquid receiver, drier filter, thermostatic valve, high- and low-pressure pressure switch, R134a refrigerant.

EVAPORATOR

With brazed stainless-steel plates and temperature sensor for protection against freezing.

Dimensions

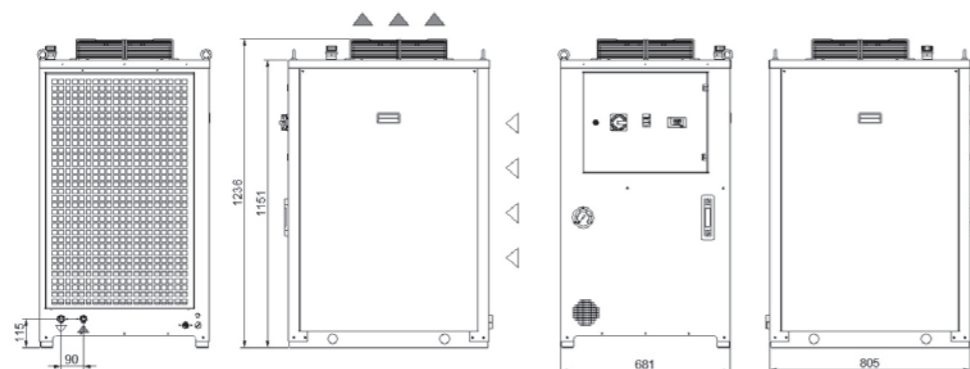

Model		TCW56	TCW70	TCW91	TCWA0
Rated Cooling Capacity*	W	6000	8100	9200	10900
Ambient temperature operating limits	°C	+15 - +45			
Settable fluid temperature range	°C	+8 - +25			
Fluid type		Water			
Temperature precision	K	+/-2			
Refrigerant gas	HFC	R134a			
Power supply					
Supply voltage	V ph Hz	400V (+/-10%) 3ph 50Hz			
Secondary supply voltage	V	230-24 V AC			
Digital thermostat		TX200			
Compressor					
Compressor type		Scroll			
Quantity - Number of circuits	no.	1 - 1			
Max. power draw	kW	3.7	3.9	4.4	4.6
Max. current draw	A	5.4	6.7	7.2	7.5
Axial Fan					
Fan type		Axial			
Quantity	no.	1	1	1	1
Air flow rate	m ³ /h	2800	2800	2800	2800
Max. power draw	W	130	130	130	130
Max. current draw	A	0.6	0.6	0.6	0.6
Centrifugal Fan (optional)					
Fan type		Centrifugal			
Quantity	no.	1	1	1	1
Air flow rate	m ³ /h	2800	2800	2800	2800
Available head	Pa	250		230	
Max. power draw	kW	0.6	0.6	0.6	0.6
Max. current draw	A	2.3	2.3	2.3	2.3
Standard Pump					
Pump type		Centrifugal			
Quantity	no.	1	1	1	1
Nominal/max fluid flow rate	l/min	17.0 - 50.0	23.0 - 50.0	26.0 - 50.0	32.0 - 50.0
Nominal available head	bar	3.0	2.8	2.5	2.3
Max. power draw	kW	0.7	0.7	0.7	0.7
Max. current draw	A	1.5	1.5	1.5	1.5
High-Pressure Pump (optional)					
Pump type		Centrifugal			
Quantity	no.	1	1	1	1
Nominal available head	bar	4.8	4.5	4.3	4.1
Max. power draw	kW	1.1	1.1	1.1	1.1
Max. current draw	A	2.2	2.2	2.2	2.2
Storage tank capacity					
Storage tank capacity	l	60			
IN/OUT liquid connections	inch	3/4"			
Net weight (approximate)***	kg	160	170	190	200
Width	mm	681			
Depth	mm	805			
Height	mm	1236			
Sound pressure level**	dB(A)	60	60	60	60
IP rating	IP	44			

* Data relating to operation under the following conditions: intake/outlet temperature 20/15°C, water without glycol, ambient temperature 32°C. Cooling power refers to the evaporator unit.

** Sound pressure level, measured in a free hemispherical field at a distance of 1 m from the machine and 1.5 metres from the ground, per ISO 3746.

*** Weight includes pallets and packaging (where provided for), with refrigerant charge, storage tank empty, axial fans.

**** The electrical data refer to cos φ = 0.8.

Correction factors for calculating the cooling power

Water outlet temperature	Fw	°C									
			8	10	15	20	25				
	factor		0.86	0.92	1	1.05	1.12				
Ambient Temperature	Fa	°C									
			15	20	25	32	35	40	45		
	factor		1.16	1.1	1.05	1	0.97	0.91	0.84		
Percentage glycol by weight	Fg	%									
			0	10	15	20	25	30	35	40	
	factor		1	0.99	0.98	0.97	0.96	0.94	0.92	0.89	

Cooling power = Nominal cooling power x Fw x Fa x Fg

TCWA2-A9 Size 3

Industrial water chillers

COOLING CAPACITY

12300 - 16400 - 17800 - 20700 W



AIR CONDENSER

Finned high-efficiency copper tube condensing coil, complete with safety grille.

AXIAL FAN

Axial fan, complete with thermal cut-out and safety grille.

LIQUID CIRCUIT

Liquid circuit composed entirely of non-ferrous material in contact with the liquid to prevent contamination. Stainless-steel centrifugal pump with 3 bar available head. Stainless-steel storage tank complete with drain valve, electrical level and visual level indicator, 0-10 bar pressure gauge, differential pressure switch protecting the water flow, regulation sensor.

ELECTRICAL PANEL

With main disconnect switch, relay motor protection, phase sequence relays.

MANAGEMENT AND CONTROL

The TX200 control unit manages the operation of the chiller and provides complete operator alarm diagnostics. An on-off contact allows the machine to be switched on remotely. Illuminated control selector. Possibility of remote display for machine regulation.

PAINT/COATING

Standard colour: RAL 7035 textured.

MAIN ACCESSORIES (ref. page 189)

BA - Mechanical bypass valve protecting the pump
HR - Fluid heating element
LTA - Operation at low ambient temperatures
FP - Polyurethane air filter

RU - Castors

TD - Differential fluid temperature management (two sensors)

LS - Liquid circuit for laser application

- HIGH-pressure pump version "H" - 5 bar, version "R" - 7 bar.

- Non-standard paint/coating

- Satin AISI 304 stainless steel framework

- Temperature Precision +/- 1 K

STRUCTURE

In powder-coated steel sheet, RAL 7035 textured finish. Easily removed panels

COMPRESSOR

Hermetic scroll compressor, cooled by the refrigerant, complete with thermal cut-out.

REFRIGERATION CIRCUIT

Complete with charging port, safety valve, liquid receiver, drier filter, liquid inspection port, solenoid valve, thermostatic valve, high- and low-pressure pressure switch, R410A refrigerant.

EVAPORATOR

With brazed stainless-steel plates and temperature sensor for protection against freezing.

Dimensions

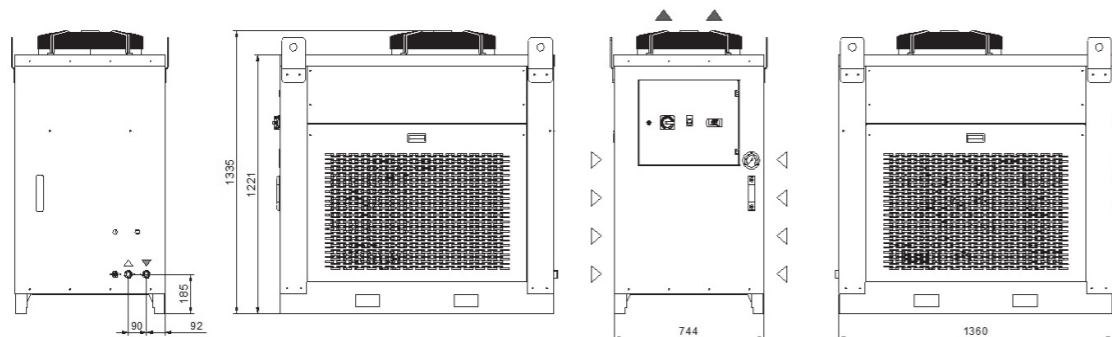

Model		TCWA2	TCWA4	TCWA7	TCWA9
Rated Cooling Capacity*	W	12300	16400	17800	20700
Ambient temperature operating limits	°C	+15 - +45			
Settable fluid temperature range	°C	+8 - +25			
Fluid type		Water			
Temperature precision	K	+/-2			
Refrigerant gas	HFC	R410A			
Power supply					
Supply voltage	V ph Hz	400V (+/-10%) 3ph 50Hz			
Secondary supply voltage	V	24 V AC			
Digital thermostat		TX200			
Compressor					
Compressor type		Scroll			
Quantity - Number of circuits	no.	1 - 1			
Max. power draw	kW	4.7	6.4	6.6	7.4
Max. current draw	A	9.8	12.1	12.5	14.8
Axial Fan					
Fan type		Axial			
Quantity	no.	1	1	1	1
Air flow rate	m ³ /h	5700	5700	5700	5700
Max. power draw	kW	0.7	0.7	0.7	0.7
Max. current draw	A	1.4	1.4	1.4	1.4
Centrifugal Fan (optional)					
Fan type		Centrifugal			
Quantity	no.	1	1	1	1
Air flow rate	m ³ /h	5700	5700	5700	5700
Available head	Pa	250	250	220	220
Max. power draw	kW	1.5	1.5	1.5	1.5
Max. current draw	A	3.0	3.0	3.0	3.0
Standard Pump					
Pump type		Centrifugal			
Quantity	no.	1	1	1	1
Nominal/max fluid flow rate	l/min	35.0 - 80.0	46.0 - 80.0	50.0 - 80.0	58.0 - 80.0
Nominal available head	bar	2.9	2.7	2.6	2.5
Max. power draw	kW	0.9	0.9	0.9	0.9
Max. current draw	A	1.7	1.7	1.7	1.7
High Pressure Pump					
Pump type		Centrifugal			
Quantity	no.	1	1	1	1
Nominal available head	bar	5.3	5.1	4.9	4.7
Max. power draw	kW	1.7	1.7	1.7	1.7
Max. current draw	A	3.0	3.0	3.0	3.0
Storage tank capacity					
Storage tank capacity	l	150			
IN/OUT liquid connections	inch	1"			
Net weight (approximate)***	kg	260	275	300	315
Width	mm	744			
Depth	mm	1360			
Height	mm	1335			
Sound pressure level**	dB(A)	67	67	67	67
IP rating	IP	44			

* Data relating to operation under the following conditions: intake/outlet temperature 20/15°C, water without glycol, ambient temperature 32°C. Cooling power refers to the evaporator unit.

** Sound pressure level, measured in a free hemispherical field at a distance of 1 m from the machine and 1.5 metres from the ground, per ISO 3746.

*** Weight includes pallets and packaging (where provided for), with refrigerant charge, storage tank empty, axial fans.

**** The electrical data refer to $\cos \phi = 0.8$.

Correction factors for calculating the cooling power

Water outlet temperature	Fw	°C									
			8	10	15	20	25				
	factor		0.86	0.92	1	1.05	1.12				
Ambient Temperature	Fa	°C									
			15	20	25	32	35	40	45		
	factor		1.16	1.1	1.05	1	0.97	0.91	0.84		
Percentage glycol by weight	Fg	%									
			0	10	15	20	25	30	35	40	
	factor		1	0.99	0.98	0.97	0.96	0.94	0.92	0.89	

Cooling power = Nominal cooling power x Fw x Fa x Fg

TCWB2-C8 Size 4

Industrial water chillers

COOLING CAPACITY

23000 - 28300 - 32800 - 37600 W



AXIAL FAN

Axial fan, complete with thermal cut-out and safety grille.

LIQUID CIRCUIT

Liquid circuit composed entirely of non-ferrous material in contact with the liquid to prevent contamination. Stainless-steel centrifugal pump with 3 bar available head. Stainless-steel storage tank complete with drain valve, electrical level and visual level indicator, 0-10 bar pressure gauge, differential pressure switch protecting the water flow, regulation sensor.

ELECTRICAL PANEL

With main disconnect switch, relay motor protection, phase sequence relays.

MANAGEMENT AND CONTROL

The TX200 control unit manages the operation of the chiller and provides complete operator alarm diagnostics. An on-off contact allows the machine to be switched on remotely. Illuminated control selector. Possibility of remote display for machine regulation.

PAINT/COATING

Standard colour: RAL 7035 textured.

STRUCTURE

In powder-coated steel sheet, RAL 7035 textured finish. Easily removed panels

COMPRESSOR

Hermetic scroll compressor, cooled by the refrigerant, complete with thermal cut-out. Complete with charging port, safety valve, liquid receiver, drier filter, liquid inspection port, solenoid valve, thermostatic valve, high- and low-pressure pressure switch, R410A refrigerant.

EVAPORATOR

With brazed stainless-steel plates and temperature sensor for protection against freezing.

AIR CONDENSER

Finned high-efficiency copper tube condensing coil, complete with safety grille.

MAIN ACCESSORIES (ref. page 189)

- BA - Mechanical bypass valve protecting the pump
- HR - Fluid heating element
- LTA - Operation at low ambient temperatures
- FP - Polyurethane air filter
- RU - Castors
- TD - Differential fluid temperature management (two sensors)
- LS - Liquid circuit for laser application
- HIGH-pressure pump version "H" - 5 bar, version "R" - 7 bar.
- Non-standard paint/coating
- Satin AISI 304 stainless steel framework
- Temperature Precision +/- 1 K

Dimensions

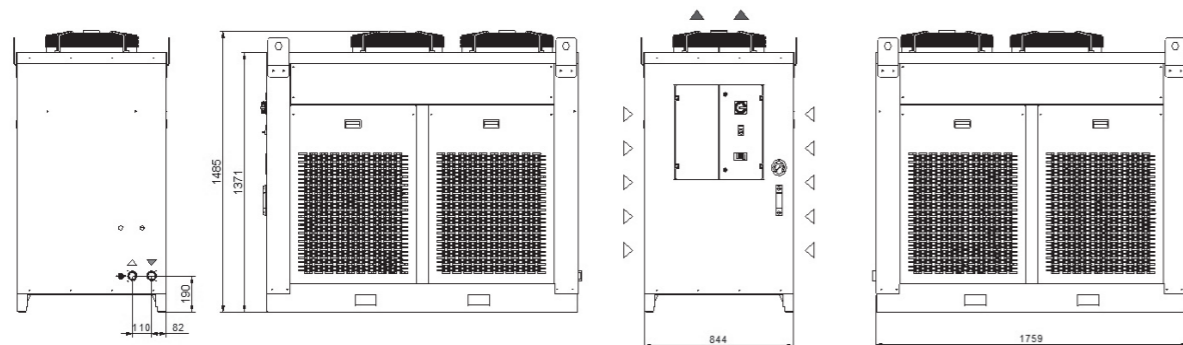

Model		TCWB2	TCWB7	TCWC1	TCWC8
Rated Cooling Capacity*	W	23000	28300	32800	37600
Ambient temperature operating limits	°C	+15 - +45			
Settable fluid temperature range	°C	+8 - +25			
Fluid type		Water			
Temperature precision	K	+/-2			
Refrigerant gas	HFC	R410A			
Power supply					
Supply voltage	V ph Hz	400V (+/-10%) 3ph 50Hz			
Secondary supply voltage	V	24 V AC			
Digital thermostat		TX200			
Compressor					
Compressor type		Scroll			
Quantity - Number of circuits	no.	1 - 1			
Max. power draw	kW	8.6	10.1	11.6	13.3
Max. current draw	A	15.0	17.3	18.8	23.0
Axial Fan					
Fan type		Axial			
Quantity	no.	2	2	2	2
Air flow rate	m ³ /h	10000	10000	10000	10000
Max. power draw	kW	1.4	1.4	1.4	1.4
Max. current draw	A	2.8	2.8	2.8	2.8
Centrifugal Fan (optional)					
Fan type		Centrifugal			
Quantity	no.	2	2	2	2
Air flow rate	m ³ /h	10000	10000	10000	10000
Available head	Pa	250	250	220	220
Max. power draw	kW	3.0	3.0	3.0	3.0
Max. current draw	A	6.0	6.0	6.0	6.0
Standard Pump					
Pump type		Centrifugal			
Quantity	no.	1	1	1	1
Nominal/max fluid flow rate	l/min	65.0 - 150.0	80.0 - 150.0	95.0 - 150.0	110.0 - 150.0
Nominal available head	bar	3.7	3.5	3.3	3.1
Max. power draw	kW	1.7	1.7	1.7	1.7
Max. current draw	A	2.9	2.9	2.9	2.9
High Pressure Pump					
Pump type		Centrifugal			
Quantity	no.	1	1	1	1
Nominal available head	bar	5.8	5.5	5.2	5.0
Max. power draw	kW	2.6	2.6	2.6	2.6
Max. current draw	A	5.1	5.1	5.1	5.1
Storage tank capacity	l	220			
IN/OUT liquid connections	inch	1 1/2"			
Net weight (approximate)***	kg	440	460	500	520
Width	mm	844			
Depth	mm	1759			
Height	mm	1485			
Sound pressure level**	dB(A)	70	70	70	70
IP rating	IP	44			

* Data relating to operation under the following conditions: intake/outlet temperature 20/15°C, water without glycol, ambient temperature 32°C. Cooling power refers to the evaporator unit.

** Sound pressure level, measured in a free hemispherical field at a distance of 1 m from the machine and 1.5 metres from the ground, per ISO 3746.

*** Weight includes pallets and packaging (where provided for), with refrigerant charge, storage tank empty, axial fans.

**** The electrical data refer to cos φ = 0.8.

Correction factors for calculating the cooling power

Water outlet temperature	Fw	°C									
			8	10	15	20	25				
	factor		0.86	0.92	1	1.05	1.12				
Ambient Temperature	Fa	°C									
			15	20	25	32	35	40	45		
	factor		1.16	1.1	1.05	1	0.97	0.91	0.84		
Percentage glycol by weight	Fg	%									
			0	10	15	20	25	30	35	40	
	factor		1	0.99	0.98	0.97	0.96	0.94	0.92	0.89	

Cooling power = Nominal cooling power x Fw x Fa x Fg

TCWD4-G8 Size 5

Industrial water chillers

COOLING CAPACITY

41400 - 46100 - 56600 - 65600 - 75200 W



EVAPORATOR

With brazed stainless-steel plates and temperature sensor for protection against freezing.

AIR CONDENSER

Finned high-efficiency copper tube condensing coil, complete with safety grille.

AXIAL FAN

Axial fan, complete with thermal cut-out and safety grille.

LIQUID CIRCUIT

Liquid circuit composed entirely of non-ferrous material in contact with the liquid to prevent contamination. Stainless-steel centrifugal pump with 3 bar available head. Stainless-steel storage tank complete with drain valve, electrical level and visual level indicator, protective flow switch, 0-10 bar pressure gauge, regulation sensor.

ELECTRICAL PANEL

With main disconnect switch, relay motor protection, phase sequence relays.

MANAGEMENT AND CONTROL

The TX400 control unit manages the operation of the chiller and provides complete operator alarm diagnostics. An on-off contact allows the machine to be switched on remotely. Illuminated control selector. Dual remote ON-OFF. Ethernet and RS485 connection. Possibility of remote display for machine regulation.

PAINT/COATING

Standard colour: RAL 7035 textured.

MAIN ACCESSORIES (ref. page 189)

- BA - Mechanical bypass valve protecting the pump
- HR - Fluid heating element
- LTA - Operation at low ambient temperatures
- FP - Polyurethane air filter
- RU - Castors
- TD - Differential fluid temperature management (two sensors)
- LS - Liquid circuit for laser application
- HIGH-pressure pump version "H" - 5 bar, version "R" - 7 bar.
- Non-standard paint/coating
- Satin AISI 304 stainless steel framework
- Temperature Precision +/- 1 K

STRUCTURE

In powder-coated steel sheet, RAL 7035 textured finish. Easily removed panels

COMPRESSOR

Hermetic scroll compressor (connected in tandem for E0 and E4 models), cooled by the refrigerant, complete with thermal cut-out.

REFRIGERATION CIRCUIT

Complete with charging port, safety valve, liquid receiver, drier filter, liquid inspection port, solenoid valve, thermostatic valve, high- and low-pressure pressure switch, R410A refrigerant. Stepped cooling power regulation, 2 steps on models TCW E0-E4-F7-G8.

Dimensions

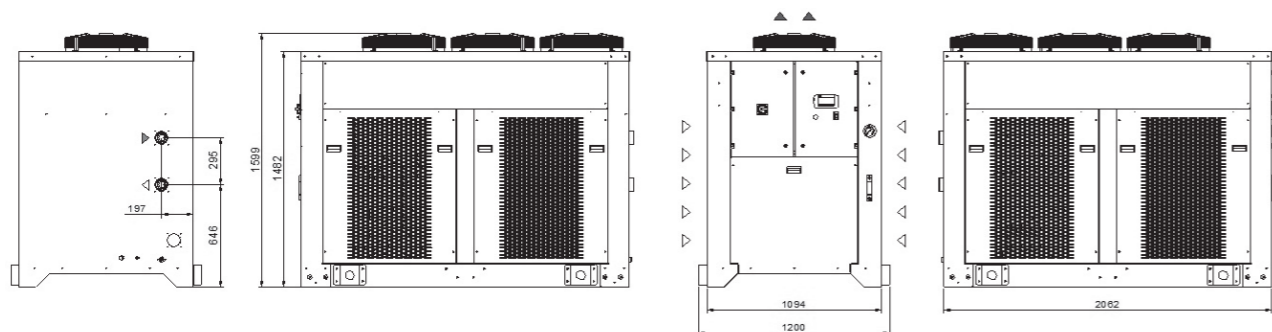

Model		TCWD4	TCWE0	TCWE4	TCWF7	TCWG8
Rated Cooling Capacity*	W	41400	46100	56600	65600	75200
Ambient temperature operating limits	°C	+15 - +45				
Settable fluid temperature range	°C	+8 - +25				
Fluid type		Water				
Temperature precision	K	+/-2				
Refrigerant gas	HFC	R410A				
Power supply						
Supply voltage	V ph Hz	400V (+/-10%) 3ph 50Hz				
Secondary supply voltage	V	24 V AC				
Digital thermostat		TX400				
Compressor						
Compressor type		Scroll				
Quantity - Number of circuits	no.	1 - 1	2 - 1		2 - 2	
Max. power draw	kW	14.8	16.7	20.2	23.2	26.6
Max. current draw	A	25.3	29.8	34.5	37.6	46.0
Axial Fan						
Fan type		Axial				
Quantity	no.	3	3	3	3	3
Air flow rate	m³/h	17000	17000	17000	17000	17000
Max. power draw	kW	2.1	2.1	2.1	2.1	2.1
Max. current draw	A	4.2	4.2	4.2	4.2	4.2
Centrifugal Fan (optional)						
Fan type		Centrifugal				
Quantity	no.	3	3	3	3	3
Air flow rate	m³/h	17000	17000	17000	17000	17000
Available head	Pa	260	260	260	230	230
Max. power draw	kW	4.5	4.5	4.5	4.5	4.5
Max. current draw	A	9.0	9.0	9.0	9.0	9.0
Standard Pump						
Pump type		Centrifugal				
Quantity	no.	1	1	1	1	1
Nominal/max fluid flow rate	l/min	115.0 - 210.0	130.0 - 210.0	160.0 - 210.0	185.0 - 400.0	215.0 - 400.0
Nominal available head	bar	3.6	3.4	3.2	3.2	3.0
Max. power draw	kW	2.3	2.3	2.3	3.0	3.0
Max. current draw	A	4.9	4.9	4.9	6.2	6.2
High-Pressure Pump (optional)						
Pump type		Centrifugal				
Quantity	no.	1	1	1	1	1
Nominal available head	bar	5.6	5.5	5.3	5.0	4.8
Max. power draw	kW	3.7	3.7	3.7	5.5	5.5
Max. current draw	A	6.3	6.3	6.3	11.0	11.0
Storage tank capacity	l	250				
IN/OUT liquid connections	inch	2 1/2"	2 1/2"	2 1/2"	2 1/2"	2 1/2"
Net weight (approximate)***	kg	600	640	680	730	750
Width	mm	1094				
Depth	mm	2062				
Height	mm	1599				
Sound pressure level**	dB(A)	72	72	72	72	72
IP rating	IP	44				

* Data relating to operation under the following conditions: intake/outlet temperature 20/15°C, water without glycol, ambient temperature 32°C. Cooling power refers to the evaporator unit.

** Sound pressure level, measured in a free hemispherical field at a distance of 1 m from the machine and 1.5 metres from the ground, per ISO 3746.

*** Weight includes pallets and packaging (where provided for), with refrigerant charge, storage tank empty, axial fans.

**** The electrical data refer to cos φ = 0.8.

Correction factors for calculating the cooling power													
Water outlet temperature	Fw	°C					8	10	15	20	25		
		factor					0.86	0.92	1	1.05	1.12		
Ambient Temperature	Fa	°C					15	20	25	32	35	40	45
		factor					1.16	1.1	1.05	1	0.97	0.91	0.84
Percentage glycol by weight	Fg	%	0	10	15	20	25	30	35	40			
		factor	1	0.99	0.98	0.97	0.96	0.94	0.92	0.89			
Cooling power = Nominal cooling power x Fw x Fa x Fg													



TCWH2-Q0 Size 6

Industrial water chillers

COOLING CAPACITY

82800 - 92200 - 113200 - 131200 - 150400 W



EVAPORATOR

With brazed stainless-steel plates and temperature sensor for protection against freezing.

AIR CONDENSER

Finned high-efficiency copper tube condensing coil, complete with safety grille.

AXIAL FAN

Axial fan, complete with thermal cut-out and safety grille. Speed regulator.

LIQUID CIRCUIT

Liquid circuit composed entirely of non-ferrous material in contact with the liquid to prevent contamination. Stainless-steel centrifugal pump with 3 bar available head. Stainless-steel storage tank complete with drain valve, electrical level and visual level indicator, protective flow switch, 0-10 bar pressure gauge, regulation sensor.

ELECTRICAL PANEL

With main disconnect switch, relay motor protection, phase sequence relays. Glass electrical protection window and aluminium frame.

MANAGEMENT AND CONTROL

The TX400 control unit manages the operation of the chiller and provides complete operator alarm diagnostics. An on-off contact allows the machine to be switched on remotely. Illuminated control selector. Dual remote ON-OFF. Ethernet and RS485 connection. Possibility of remote display for machine regulation.

PAINT/COATING

Standard colour: RAL 7035 textured.

STRUCTURE

In powder-coated steel sheet, RAL 7035 textured finish. Easily removed panels Chiller for outdoor installation.

COMPRESSOR

Hermetic scroll compressor (connected in tandem for I3 and M4 models), cooled by the refrigerant, complete with thermal cut-out and casing heating element for heating the oil. Stepped cooling power regulation, 2 steps on model TCWH2, 4 steps on models TCW I3-M4-O1-Q0.

REFRIGERATION CIRCUIT

Complete with charging port, safety valve, liquid receiver, drier filter, liquid inspection port, solenoid valve, thermostatic valve, high- and low-pressure pressure switch, R410A refrigerant.

MAIN ACCESSORIES (ref. page 189)

- BA - Mechanical bypass valve protecting the pump
- HR - Fluid heating element
- FP - Polyurethane air filter
- RU - Castors
- TD - Differential fluid temperature management (two sensors)
- LS - Liquid circuit for laser application
- HIGH-pressure pump version "H" - 5 bar, version "R" - 7 bar.
- Non-standard paint/coating
- Satin AISI 304 stainless steel framework
- Temperature Precision +/- 1 K

Dimensions

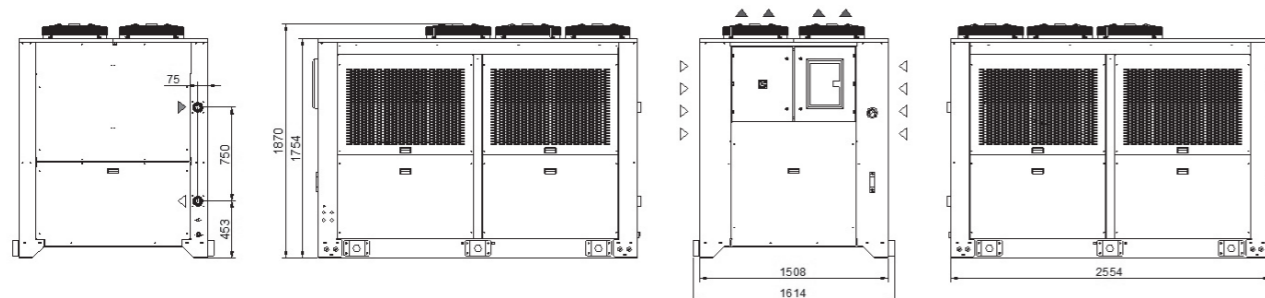

Model		TCWH2	TCW13	TCWM4	TCWO1	TCWQ0
Rated Cooling Capacity*	W	82800	92200	113200	131200	150400
Ambient temperature operating limits	°C	-10 - +45				
Settable fluid temperature range	°C	+8 - +25				
Fluid type		Water				
Temperature precision	K	+/-2				
Refrigerant gas	HFC	R410A				
Power supply						
Supply voltage	V ph Hz	400V (+/-10%) 3ph 50Hz				
Secondary supply voltage	V	24 V AC				
Digital thermostat		TX400				
Compressor						
Compressor type		Scroll				
Quantity - Number of circuits	no.	2 - 2	4 - 2		4 - 4	
Max. power draw	kW	29.6	33.4	40.2	46.4	53.2
Max. current draw	A	50.6	59.6	69.0	75.2	92.0
Axial Fan						
Fan type		Axial				
Quantity	no.	6	6	6	6	6
Air flow rate	m³/h	34000	34000	34000	34000	34000
Max. power draw	kW	4.2	4.2	4.2	4.2	4.2
Max. current draw	A	8.4	8.4	8.4	8.4	8.4
Centrifugal Fan (optional)						
Fan type		Centrifugal				
Quantity	no.	6	6	6	6	6
Air flow rate	m³/h	34000	34000	34000	34000	34000
Available head	Pa	260	260	260	230	230
Max. power draw	kW	9.0	9.0	9.0	9.0	9.0
Max. current draw	A	18.0	18.0	18.0	18.0	18.0
Standard Pump						
Pump type		Centrifugal				
Quantity	no.	1	1	1	1	1
Nominal/max fluid flow rate	l/min	230.0 - 400.0	260.0 - 400.0	320.0 - 400.0	370.0 - 800.0	430.0 - 800.0
Nominal available head	bar	3.0	2.9	2.6	2.9	2.7
Max. power draw	kW	3.0	3.0	3.0	4.0	4.0
Max. current draw	A	6.2	6.2	6.2	8.0	8.0
High-Pressure Pump (optional)						
Pump type		Centrifugal				
Quantity	no.	1	1	1	1	1
Nominal available head	bar	4.8	4.7	4.4	5.5	5.4
Max. power draw	kW	5.5	5.5	5.5	9.0	9.0
Max. current draw	A	11.0	11.0	11.0	16.0	16.0
Storage tank capacity						
Storage tank capacity	l	500				
IN/OUT liquid connections	inch	2 1/2"	2 1/2"	2 1/2"	2 1/2"	2 1/2"
Net weight (approximate)***	kg	1500	1650	1650	1800	1800
Width	mm	1508				
Depth	mm	2554				
Height	mm	1870				
Sound pressure level**	dB(A)	75	75	75	75	75
IP rating	IP	54				

* Data relating to operation under the following conditions: intake/outlet temperature 20/15°C, water without glycol, ambient temperature 32°C. Cooling power refers to the evaporator unit.

** Sound pressure level, measured in a free hemispherical field at a distance of 1 m from the machine and 1.5 metres from the ground, per ISO 3746.

*** Weight includes pallets and packaging (where provided for), with refrigerant charge, storage tank empty, axial fans.

**** The electrical data refer to $\cos \phi = 0.8$.

Correction factors for calculating the cooling power

Water outlet temperature	Fw	°C									
			8	10	15	20	25				
	factor		0.86	0.92	1	1.05	1.12				
Ambient Temperature	Fa	°C									
			15	20	25	32	35	40	45		
	factor		1.16	1.1	1.05	1	0.97	0.91	0.84		
Percentage glycol by weight	Fg	%									
			0	10	15	20	25	30	35	40	
	factor		1	0.99	0.98	0.97	0.96	0.94	0.92	0.89	

Cooling power = Nominal cooling power x Fw x Fa x Fg

TCWR2-Z0 Size 7

Industrial water chillers

COOLING CAPACITY

166600 - 184400 - 226400 - 262400 - 300800 W



EVAPORATOR

With brazed stainless-steel plates and temperature sensor for protection against freezing.

AIR CONDENSER

Finned high-efficiency copper tube condensing coil, complete with safety grille.

AXIAL FAN

Axial fan, complete with thermal cut-out and safety grille. Speed regulator.

LIQUID CIRCUIT

Liquid circuit composed entirely of non-ferrous material in contact with the liquid to prevent contamination. Stainless-steel centrifugal pump with 3 bar available head. Storage tank, closed expansion vessel with pressure reducer and automatic filling system, complete with drain valve, 0-10 bar pressure gauge. Circuit protection consists of a flow switch, minimum pressure switch (normally disabled, operation to be assessed during the initial installation phase), maximum pressure switch, tank max. pressure safety valve, regulation sensor.

ELECTRICAL PANEL

With main disconnect switch, relay motor protection, phase sequence relays. Glass electrical protection window and aluminium frame.

MANAGEMENT AND CONTROL

The TX400 control unit manages the operation of the chiller and provides complete operator alarm diagnostics. An on-off contact allows the machine to be switched on remotely. Illuminated control selector. Dual remote ON-OFF. Ethernet and RS485 connection. Possibility of remote display for machine regulation.

PAINT/COATING

Standard colour: RAL 7035 textured.

MAIN ACCESSORIES (ref. page 189)

- BA - Mechanical bypass valve protecting the pump
- BM - Manual mechanical bypass valve protecting the pump
- HR - Fluid heating element
- AV - Vibration damper supports
- FP - Polyurethane air filters
- TD - Differential fluid temperature management (two sensors)
- HIGH-pressure pump version "H" - 5 bar, version "R" - 7 bar.
- Non-standard paint/coating
- Satin AISI 304 stainless steel framework
- Temperature Precision +/- 1 K

STRUCTURE

In powder-coated steel sheet, RAL 7035 textured finish. Easily removed panels Chiller for outdoor installation.

COMPRESSOR

Hermetic scroll compressor, connected in tandem, cooled by the refrigerant, complete with thermal cut-out and casing heating element for heating the oil. Stepped cooling power regulation, 4 steps on model TCWR2 , 8 steps on models TCW S4-T6-Q0-Z0.

REFRIGERATION CIRCUIT

Complete with charging port, safety valve, liquid receiver, drier filter, liquid inspection port, solenoid valve, thermostatic valve, high- and low-pressure pressure switch, R410A refrigerant.

Dimensions

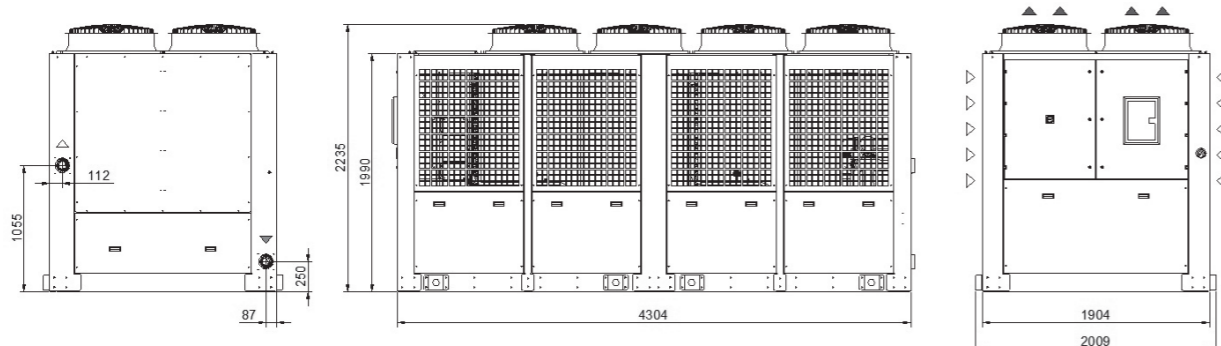

Model		TCWR2	TCWS4	TCWT6	TCWV3	TCWZ0
Rated Cooling Capacity*	W	166600	184400	226400	262400	300800
Ambient temperature operating limits	°C	-10 - +45				
Settable fluid temperature range	°C	+8 - +25				
Fluid type		Water				
Temperature precision	K	+/-2.5				
Refrigerant gas	HFC	R410A				
Power supply						
Supply voltage	V ph Hz	400V (+/-10%) 3ph 50Hz				
Secondary supply voltage	V	24 V AC				
Digital thermostat		TX400				
Compressor						
Compressor type		Scroll				
Quantity - Number of circuits	no.	4 - 2	8 - 4			
Max. power draw	kW	59.2	66.8	80.4	92.8	106.4
Max. current draw	A	101.2	119.2	138.0	150.4	194.0
Capacity steps	NR x %	8x12.5%				
Axial Fan						
Fan type		Axial				
Quantity	no.	4	8	8	8	8
Air flow rate	m³/h	86000	86000	86000	86000	86000
Max. power draw	kW	8.3	8.3	8.3	8.3	8.3
Max. current draw	A	11.6	11.6	11.6	11.6	11.6
Centrifugal Fan (optional)						
Fan type		Centrifugal				
Quantity	no.	6	6	8	8	8
Air flow rate	m³/h	72000	72000	72000	72000	72000
Available head	Pa	260	260	260	260	260
Max. power draw	kW	16.0	16.0	16.0	16.0	16.0
Max. current draw	A	28.0	28.0	28.0	28.0	28.0
Standard Pump						
Pump type		Centrifugal				
Quantity	no.	1	1	1	1	1
Nominal/max fluid flow rate	l/min	460 - 800	520 - 800	640 - 1400	740 - 1400	860 - 1400
Nominal available head	bar	2.9	2.6	3.2	3.1	3.0
Max. power draw	kW	4.0	4.0	7.5	7.5	7.5
Max. current draw	A	8.1	8.1	14.6	14.6	14.6
High-Pressure Pump (optional)						
Pump type		Centrifugal				
Quantity	no.	1	1	1	1	1
Nominal available head	bar	5.6	5.2	6.1	5.9	5.4
Max. power draw	kW	11.0	11.0	15.0	15.0	15.0
Max. current draw	A	21.2	21.2	28.6	28.6	28.6
Storage tank capacity	l	500				
Expansion vessel capacity	l	18				
IN/OUT liquid connections	inch	4"	4"	4"	4"	4"
Net weight (approximate)***	kg	2000	2450	2500	2650	2700
Width	mm	1904				
Depth	mm	4304				
Height	mm	2235				
Sound pressure level**	dB(A)	79	79	79	79	79
IP rating	IP	54				

* Data relating to operation under the following conditions: intake/outlet temperature 20/15°C, water without glycol, ambient temperature 32°C. Cooling power refers to the evaporator unit.
 ** Sound pressure level, measured in a free hemispherical field at a distance of 1 m from the machine and 1.5 metres from the ground, per ISO 3746.
 *** Weight includes pallets and packaging (where provided for), with refrigerant charge, storage tank empty, axial fans.
 **** The electrical data refer to cos φ = 0.8.

Correction factors for calculating the cooling power													
Water outlet temperature	Fw	°C					8	10	15	20	25		
		factor					0.86	0.92	1	1.05	1.12		
Ambient Temperature	Fa	°C					15	20	25	32	35	40	45
		factor					1.16	1.1	1.05	1	0.97	0.91	0.84
Percentage glycol by weight	Fg	%	0	10	15	20	25	30	35	40			
		factor	1	0.99	0.98	0.97	0.96	0.94	0.92	0.89			
Cooling power = Nominal cooling power x Fw x Fa x Fg													

TCW3E-4A Size 8

Industrial water chillers

COOLING CAPACITY

355000 - 400000 W



EVAPORATOR

With brazed stainless-steel plates and temperature sensor for protection against freezing.

AIR CONDENSER

Finned high-efficiency copper tube condensing coil, complete with safety grille.

AXIAL FAN

Axial fan, complete with thermal cut-out and safety grille. Speed regulator.

LIQUID CIRCUIT

Liquid circuit composed entirely of non-ferrous material in contact with the liquid to prevent contamination. Stainless-steel centrifugal pump with 3 bar available head. Storage tank, closed expansion vessel with pressure reducer and automatic filling system, complete with drain valve, 0-10 bar pressure gauge. Circuit protection consists of a flow switch, minimum pressure switch (normally disabled, operation to be assessed during the initial installation phase), maximum pressure switch, tank max. pressure safety valve, regulation sensor.

ELECTRICAL PANEL

With main disconnect switch, relay motor protection, phase sequence relays. Glass electrical protection window and aluminium frame.

MANAGEMENT AND CONTROL

The TX400 control unit manages the operation of the chiller and provides complete operator alarm diagnostics. An on-off contact allows the machine to be switched on remotely. Illuminated control selector. Dual remote ON-OFF. Ethernet and RS485 connection. Possibility of remote display for machine regulation.

PAINT/COATING

Standard colour: RAL 7035 textured.

MAIN ACCESSORIES (ref. page 189)

- BA - Mechanical bypass valve protecting the pump
- BM - Manual mechanical bypass valve protecting the pump
- HR - Fluid heating element
- AV - Vibration damper supports
- FP - Polyurethane air filters
- TD - Differential fluid temperature management (two sensors)
 - HIGH-pressure pump version "H" - 5 bar, version "R" - 7 bar.
 - Non-standard paint/coating
 - Satin AISI 304 stainless steel framework
 - Temperature Precision +/- 1 K

STRUCTURE

In powder-coated steel sheet, RAL 7035 textured finish. Easily removed panels Chiller for outdoor installation.

COMPRESSOR

Hermetic scroll compressor, connected in tandem, cooled by the refrigerant, complete with thermal cut-out and casing heating element for heating the oil. Stepped cooling power regulation, 8 steps on all models.

REFRIGERATION CIRCUIT

Complete with charging port, safety valve, liquid receiver, drier filter, liquid inspection port, solenoid valve, thermostatic valve, high- and low-pressure pressure switch, R410A refrigerant.

Dimensions

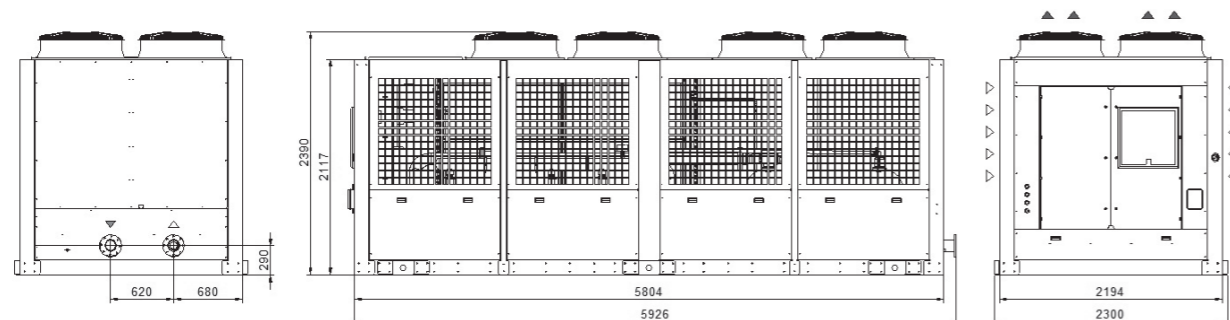

Model		TCW3E	TCW4A
Rated Cooling Capacity*	W	355000	400000
Ambient temperature operating limits	°C		-10 - +45
Settable fluid temperature range	°C		+8 - +25
Fluid type			Water
Temperature precision	K		+/-2.5
Refrigerant gas	HFC		R410A
Power supply			
Supply voltage	V ph Hz	400V (+/-10%) 3ph 50Hz	
Secondary supply voltage	V	24 V AC	
Digital thermostat		TX400	
Compressor			
Compressor type		Scroll	
Quantity - Number of circuits	no.	8 - 4	8 - 4
Max. power draw	kW	12.0	13.6
Max. current draw	A	20.5	24.0
Capacity steps	NR x %	8x12.5%	
Axial Fan			
Fan type		Axial	
Quantity	no.	8	8
Air flow rate	m³/h	115000	115000
Max. power draw	kW	12.0	12.0
Max. current draw	A	23.4	23.4
Centrifugal Fan (optional)			
Fan type		Centrifugal	
Quantity	no.	8	8
Air flow rate	m³/h	115000	115000
Available head	Pa	250	250
Max. power draw	kW	29.0	29.0
Max. current draw	A	48.0	48.0
Standard Pump			
Pump type		Centrifugal	
Quantity	no.	1	1
Nominal/max fluid flow rate	l/min	1010	1150
Nominal available head	bar	4.5	4.2
Max. power draw	kW	11.0	11.0
Max. current draw	A	20.0	20.0
High-Pressure Pump (optional)			
Pump type		Centrifugal	
Quantity	no.	1	1
Nominal available head	bar	6.5	6.2
Max. power draw	kW	22.0	22.0
Max. current draw	A	40.0	40.0
Storage tank capacity	l	800	
Expansion vessel capacity	l	18	
IN/OUT liquid connections	inch	DN 100	DN 100
Net weight (approximate)***	kg	3700	3800
Width	mm	2194	
Depth	mm	5804	
Height	mm	2390	
Sound pressure level**	dB(A)	79	79
IP rating	IP	54	

* Data relating to operation under the following conditions: intake/outlet temperature 20/15°C, water without glycol, ambient temperature 32°C. Cooling power refers to the evaporator unit.

** Sound pressure level, measured in a free hemispherical field at a distance of 1 m from the machine and 1.5 metres from the ground, per ISO 3746.

*** Weight includes pallets and packaging (where provided for), with refrigerant charge, storage tank empty, axial fans.

**** The electrical data refer to $\cos \phi = 0.8$.

Correction factors for calculating the cooling power

Water outlet temperature	Fw	°C									
			8	10	15	20	25				
	factor		0.86	0.92	1	1.05	1.12				
Ambient Temperature	Fa	°C									
			15	20	25	32	35	40	45		
	factor		1.16	1.1	1.05	1	0.97	0.91	0.84		
Percentage glycol by weight	Fg	%									
			0	10	15	20	25	30	35	40	
	factor		1	0.99	0.98	0.97	0.96	0.94	0.92	0.89	

Cooling power = Nominal cooling power x Fw x Fa x Fg

LCW

Negative temperature liquid chillers

When very low cooling temperatures are required, **texa industries'** LCW range is your guarantee for maximum performance of your industrial equipment.



LCW15-22 Size 2

Negative temperature liquid chillers

COOLING CAPACITY

2200 - 3400 W



EVAPORATOR

With brazed stainless-steel plates with sensor for protection against freezing.

AIR CONDENSER

Finned high-efficiency copper tube condensing coil, complete with safety grille.

AXIAL FAN

Axial fan, complete with thermal cut-out and safety grille. Fan adjustment step pressure switch.

LIQUID CIRCUIT

Liquid circuit composed entirely of non-ferrous material in contact with the liquid to prevent contamination. Stainless-steel centrifugal pump with 3 bar available head. Stainless-steel storage tank complete with drain valve, electrical level and visual level indicator, 0-10 bar pressure gauge, protective flow switch, regulation sensor.

ELECTRICAL PANEL

With main disconnect switch, relay motor protection, phase sequence relays.

MANAGEMENT AND CONTROL

The TX200 control unit manages the operation of the chiller and provides complete operator alarm diagnostics. An on-off contact allows the machine to be switched on remotely. Illuminated control selector. Possibility of remote display for machine regulation.

STRUCTURE

In powder-coated steel sheet, RAL 7035 textured finish. Easily removed panels

COMPRESSOR

Hermetic scroll compressor, cooled by the refrigerant, complete with thermal cut-out. Case heating element for oil. Mechanical management coolant injection valve.

REFRIGERATION CIRCUIT

Complete with charging port, drier filter, liquid receiver, thermostatic valve, solenoid valve, liquid viewing port, high- and low-pressure pressure switch, intake oil separator, R404A refrigerant. Solenoid valve for liquid injection. High- and low-pressure gas pressure gauge.

PAINT/COATING

Standard colour: RAL 7035 textured.

MAIN ACCESSORIES (ref. page 189)

- BA - Mechanical bypass valve protecting the pump
- HR - Fluid heating element
- LTA - Operation at low ambient temperatures
- FP - Polyurethane air filter
- RU - Castors
- TD - Differential fluid temperature management (two sensors)
- HIGH-pressure pump version "H" - 5 bar.
- Non-standard paint/coating
- Satin AISI 304 stainless steel framework

Dimensions

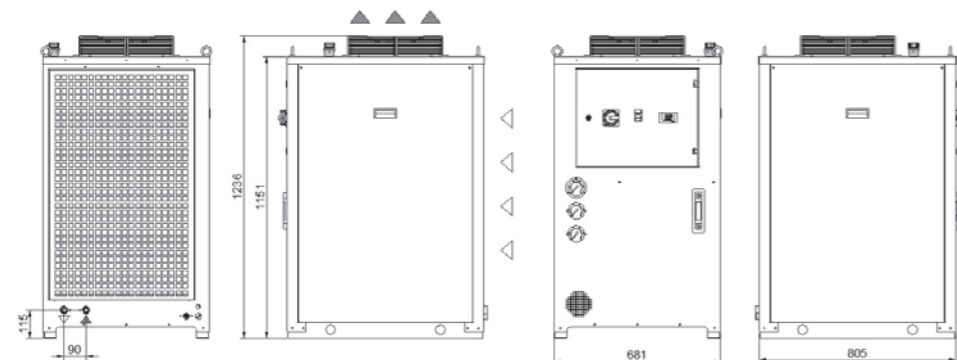

Model		LCW15	LCW22
Rated Cooling Capacity*	W	2200	3400
Ambient temperature operating limits	°C	+15 - +48	
Settable fluid temperature range	°C	-30 - -5	
Fluid type		Water + Ethylene Glycol 50%	
Temperature precision	K	+/-2	
Refrigerant gas	HFC	R404A	
Power supply			
Supply voltage	V ph Hz	400V (+/-10%) 3ph 50Hz	
Secondary supply voltage	V	24 V AC	
Digital thermostat		TX200	
Compressor			
Compressor type		Scroll	
Quantity - Number of circuits	no.	1 - 1	1 - 1
Max. power draw	kW	4.0	7.8
Max. current draw	A	7.3	12.0
Axial Fan			
Compressor type		Axial	
Quantity	no.	1 - 1	
Air flow rate	m³/h	2800	
Max. power draw	W	130	
Max. current draw	A	0.6	
Centrifugal Fan (optional)			
Fan type		Centrifugal	
Quantity	no.	1	1
Air flow rate	m³/h	2800	
Available head	Pa	230	
Max. power draw	kW	0.6	
Max. current draw	A	2.3	
Standard Pump			
Pump type		Centrifugal	
Quantity	no.	1	
Nominal/max fluid flow rate	l/min	10.0 - 50.0	15.0 - 50.0
Nominal available head	bar	3.5	3.3
Available power draw	kW	0.9	
Max. current draw	A	1.7	
High-Pressure Pump (optional)			
Pump type		Centrifugal	
Quantity	no.	1	
Nominal available head	bar	5.1	4.9
Max. power draw	kW	1.4	
Max. current draw	A	2.7	
Storage tank capacity	l	30	
IN/OUT liquid connections	inch	3/4"	
Net weight (approximate)***	kg	195	200
Width	mm	681	
Depth	mm	805	
Height	mm	1236	
Sound pressure level**	dB(A)	60	
IP rating	IP	44	

* Data relating to operation under the following conditions: intake/outlet temperature -20/-25°C, water with 50% glycol, ambient temperature 32°C. Cooling power refers to the evaporator unit.

** Sound pressure level, measured in a free hemispherical field at a distance of 1 m from the machine and 1.5 metres from the ground, per ISO 3746.

*** Weight includes pallets and packaging (where provided for), with refrigerant charge, storage tank empty, axial fans.

**** The electrical data refer to cos φ = 0.8.

Correction factors for calculating the cooling power														
Water outlet temperature	Fw	°C	-30	-28	-26	-25	-22	-20	-18	-16	-14	-12	-10	-5
		factor	0.75	0.85	0.95	1.00	1.1	1.20	1.30	1.42	1.54	1.64	1.76	1.80
Ambient Temperature	Fa	°C					15	20	25	32	35	40	48	
		factor					1.16	1.10	1.05	1.00	0.97	0.91	0.84	
Percentage glycol by weight	Fg	%										50		
		factor										1.00		

Cooling power = Nominal cooling power x Fw x Fa x Fg



LCW45-70 Size 3

Negative temperature liquid chillers

COOLING CAPACITY

6500 - 10450 W



EVAPORATOR

With brazed stainless-steel plates with sensor for protection against freezing.

AIR CONDENSER

Finned high-efficiency copper tube condensing coil, complete with safety grille.

AXIAL FAN

Axial fan, complete with thermal cut-out and safety grille. Fan adjustment step pressure switch.

LIQUID CIRCUIT

Liquid circuit composed entirely of non-ferrous material in contact with the liquid to prevent contamination. Stainless-steel centrifugal pump with 3 bar available head. Stainless-steel storage tank complete with drain valve, electrical level and visual level indicator, 0-10 bar pressure gauge, protective flow switch, regulation sensor.

ELECTRICAL PANEL

With main disconnect switch, relay motor protection, phase sequence relays.

MANAGEMENT AND CONTROL

The TX200 control unit manages the operation of the chiller and provides complete operator alarm diagnostics. An on-off contact allows the machine to be switched on remotely. Illuminated control selector. Possibility of remote display for machine regulation.

PAINT/COATING

Standard colour: RAL 7035 textured.

MAIN ACCESSORIES (ref. page 189)

- BA - Mechanical bypass valve protecting the pump
- HR - Fluid heating element
- LTA - Operation at low ambient temperatures
- FP - Polyurethane air filter
- RU - Castors
- TD - Differential fluid temperature management (two sensors)
- HIGH-pressure pump version "H" - 5 bar.
- Non-standard paint/coating
- Satin AISI 304 stainless steel framework

STRUCTURE

In powder-coated steel sheet, RAL 7035 textured finish. Easily removed panels

COMPRESSOR

Hermetic scroll compressor (connected in tandem for model 70), cooled by the refrigerant, complete with thermal cut-out. Case heating element for oil. Electronic management coolant injection valve.

REFRIGERATION CIRCUIT

Complete with charging port, drier filter, liquid receiver, thermostatic valve, solenoid valve, liquid viewing port, high- and low-pressure pressure switch, intake oil separator, R404A refrigerant. Solenoid valve for liquid injection. High- and low-pressure gas pressure gauge.

Dimensions

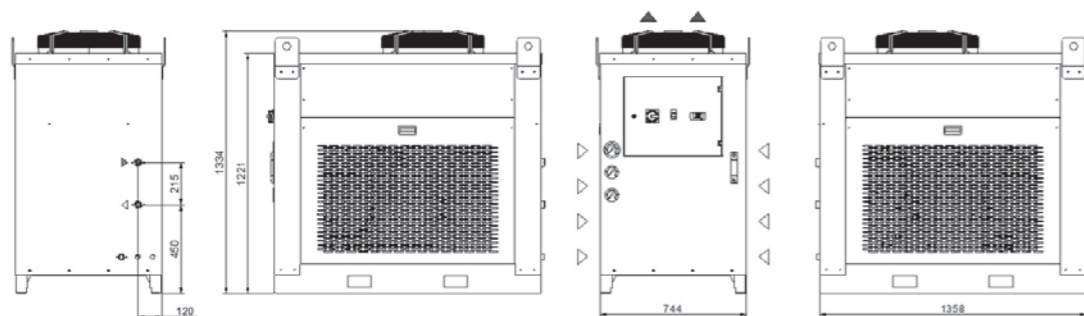

Model		LCW45	LCW70
Rated Cooling Capacity*	W	6500	10450
Ambient temperature operating limits	°C	+15 - +48	
Settable fluid temperature range	°C	-30 - -5	
Fluid type		Water + Ethylene Glycol 50%	
Temperature precision	K	+/-2	
Refrigerant gas	HFC	R404A	
Power supply			
Supply voltage	V ph Hz	400V (+/-10%) 3ph 50Hz	
Secondary supply voltage	V	24 V AC	
Digital thermostat		TX200	
Compressor			
Compressor type		Scroll	
Quantity - Number of circuits	no.	1 - 1	2 - 1
Max. power draw	kW	14.0	22.0
Max. current draw	A	23.5	37.4
Axial Fan			
Compressor type		Axial	
Quantity	no.	1 - 1	
Air flow rate	m ³ /h	5700	
Max. power draw	kW	0.7	
Max. current draw	A	1.4	
Centrifugal Fan (optional)			
Fan type		Centrifugal	
Quantity	no.	1	1
Air flow rate	m ³ /h	5700	5700
Available head	Pa	220	220
Max. power draw	kW	1.5	1.5
Max. current draw	A	3.0	3.0
Standard Pump			
Pump type		Centrifugal	
Quantity	no.	1	
Nominal/max fluid flow rate	l/min	25.0 - 80.0	35.0 - 80.0
Nominal available head	bar	3.7	3.5
Available power draw	kW	1.2	
Max. current draw	A	2.4	
High-Pressure Pump (optional)			
Pump type		Centrifugal	
Quantity	no.	1	
Nominal available head	bar	5.1	4.9
Max. power draw	kW	2.6	
Max. current draw	A	5.1	
Storage tank capacity	l	60	
IN/OUT liquid connections	inch	1"	
Net weight (approximate)***	kg	350	380
Width	mm	744	
Depth	mm	1358	
Height	mm	1334	
Sound pressure level**	dB(A)	67	68
IP rating	IP	44	

* Data relating to operation under the following conditions: intake/outlet temperature -20/-25°C, water with 50% glycol, ambient temperature 32°C. Cooling power refers to the evaporator unit.

** Sound pressure level, measured in a free hemispherical field at a distance of 1 m from the machine and 1.5 metres from the ground, per ISO 3746.

*** Weight includes pallets and packaging (where provided for), with refrigerant charge, storage tank empty, axial fans.

**** The electrical data refer to cos φ = 0.8.

Correction factors for calculating the cooling power														
Water outlet temperature	Fw	°C	-30	-28	-26	-25	-22	-20	-18	-16	-14	-12	-10	-5
		factor	0.75	0.85	0.95	1.00	1.1	1.20	1.30	1.42	1.54	1.64	1.76	1.80
Ambient Temperature	Fa	°C					15	20	25	32	35	40	48	
		factor					1.16	1.10	1.05	1.00	0.97	0.91	0.84	
Percentage glycol by weight	Fg	%										50		
		factor										1.00		

Cooling power = Nominal cooling power x Fw x Fa x Fg

LCWA2-A8 Size 4

Negative temperature liquid chillers

COOLING CAPACITY

13000 - 19600 W



EVAPORATOR

With brazed stainless-steel plates with sensor for protection against freezing.

AIR CONDENSER

Finned high-efficiency copper tube condensing coil, complete with safety grille.

AXIAL FAN

Axial fan, complete with thermal cut-out and safety grille. Fan adjustment step pressure switch.

LIQUID CIRCUIT

Liquid circuit composed entirely of non-ferrous material in contact with the liquid to prevent contamination. Stainless-steel centrifugal pump with 3 bar available head. Stainless-steel storage tank complete with drain valve, electrical level and visual level indicator, 0-10 bar pressure gauge, protective flow switch, regulation sensor.

ELECTRICAL PANEL

With main disconnect switch, relay motor protection, phase sequence relays.

MANAGEMENT AND CONTROL

The TX200 control unit manages the operation of the chiller and provides complete operator alarm diagnostics. An on-off contact allows the machine to be switched on remotely. Illuminated control selector. Possibility of remote display for machine regulation.

STRUCTURE

In powder-coated steel sheet, RAL 7035 textured finish. Easily removed panels

COMPRESSOR

Hermetic scroll compressor (connected in tandem), cooled by the refrigerant, complete with thermal cut-out. Case heating element for oil. Electronic management coolant injection valve.

REFRIGERATION CIRCUIT

Complete with charging port, drier filter, liquid receiver, thermostatic valve, solenoid valve, liquid viewing port, high- and low-pressure pressure switch, intake oil separator, R404A refrigerant. Solenoid valve for liquid injection. High- and low-pressure gas pressure gauge.

PAINT/COATING

Standard colour: RAL 7035 textured.

MAIN ACCESSORIES (ref. page 189)

- BA - Mechanical bypass valve protecting the pump
- HR - Fluid heating element
- LTA - Operation at low ambient temperatures
- FP - Polyurethane air filter
- RU - Castors
- TD - Differential fluid temperature management (two sensors)
- HIGH-pressure pump version "H" - 5 bar.
- Non-standard paint/coating
- Satin AISI 304 stainless steel framework

Dimensions

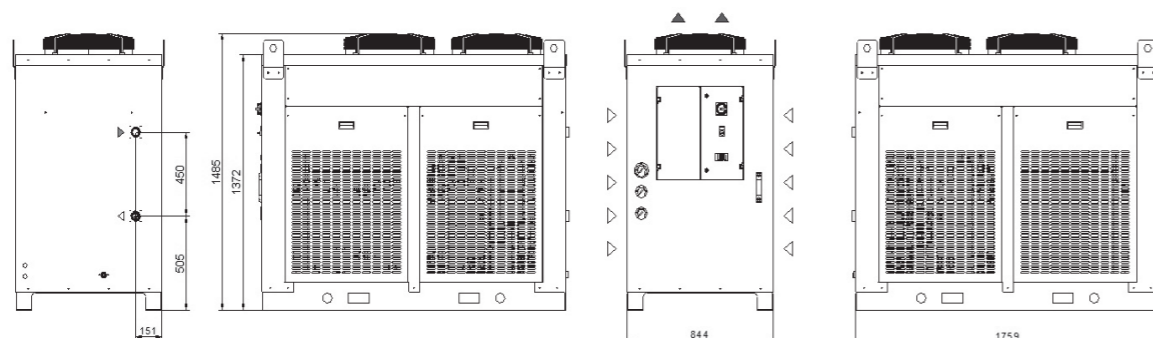

Model		LCWA2	LCWA8
Rated Cooling Capacity*	W	13000	19600
Ambient temperature operating limits	°C	+15 - +48	
Settable fluid temperature range	°C	-30 - -5	
Fluid type		Water + Ethylene Glycol 50%	
Temperature precision	K	+/-2	
Refrigerant gas	HFC	R404A	
Power supply			
Supply voltage	V ph Hz	400V (+/-10%) 3ph 50Hz	
Secondary supply voltage	V	24 V AC	
Digital thermostat		TX200	
Compressor			
Compressor type		Scroll	
Quantity - Number of circuits	no.	2 - 1	3 - 1
Max. power draw	kW	28.0	42.0
Max. current draw	A	47.0	70.5
Axial Fan			
Compressor type		Axial	
Quantity	no.	2	
Air flow rate	m ³ /h	10000	
Max. power draw	kW	1.4	
Max. current draw	A	2.8	
Centrifugal Fan (optional)			
Fan type		Centrifugal	
Quantity	no.	2	2
Air flow rate	m ³ /h	10000	10000
Available head	Pa	220	220
Max. power draw	kW	3.0	3.0
Max. current draw	A	6.0	6.0
Standard Pump			
Pump type		Centrifugal	
Quantity	no.	1	
Nominal/max fluid flow rate	l/min	50.0 - 150.0	75.0 - 150.0
Nominal available head	bar	3.7	3.3
Available power draw	kW	1.4	
Max. current draw	A	2.8	
High-Pressure Pump (optional)			
Pump type		Centrifugal	
Quantity	no.	1	
Nominal available head	bar	5.4	5.1
Max. power draw	kW	2.8	
Max. current draw	A	5.3	
Storage tank capacity	l	120	
IN/OUT liquid connections	inch	1 1/2"	
Net weight (approximate)***	kg	550	610
Width	mm	844	
Depth	mm	1759	
Height	mm	1485	
Sound pressure level**	dB(A)	70	72
IP rating	IP	44	

* Data relating to operation under the following conditions: intake/outlet temperature -20/-25°C, water with 50% glycol, ambient temperature 32°C. Cooling power refers to the evaporator unit.

** Sound pressure level, measured in a free hemispherical field at a distance of 1 m from the machine and 1.5 metres from the ground, per ISO 3746.

*** Weight includes pallets and packaging (where provided for), with refrigerant charge, storage tank empty, axial fans.

**** The electrical data refer to cos φ = 0.8.

Correction factors for calculating the cooling power														
Water outlet temperature	Fw	°C	-30	-28	-26	-25	-22	-20	-18	-16	-14	-12	-10	-5
		factor	0.75	0.85	0.95	1.00	1.1	1.20	1.30	1.42	1.54	1.64	1.76	1.80
Ambient Temperature	Fa	°C				15	20	25	32	35	40	48		
		factor				1.16	1.10	1.05	1.00	0.97	0.91	0.84		
Percentage glycol by weight	Fg	%										50		
		factor										1.00		

Cooling power = Nominal cooling power x Fw x Fa x Fg

LCWB5-C4 Size 5

Negative temperature liquid chillers

COOLING CAPACITY

24100 - 34800 W



EVAPORATOR

With brazed stainless-steel plates with sensor for protection against freezing.

AIR CONDENSER

Finned high-efficiency copper tube condensing coil, complete with safety grille. Fan adjustment step pressure switch.

AXIAL FAN

Axial fan, complete with thermal cut-out and safety grille.

LIQUID CIRCUIT

Liquid circuit composed entirely of non-ferrous material in contact with the liquid to prevent contamination. Stainless-steel centrifugal pump with 3 bar available head. Stainless-steel storage tank complete with drain valve, electrical level and visual level indicator, 0-10 bar pressure gauge, protective flow switch, regulation sensor.

ELECTRICAL PANEL

With main disconnect switch, relay motor protection, phase sequence relays.

MANAGEMENT AND CONTROL

The TX200 control unit manages the operation of the chiller and provides complete operator alarm diagnostics. An on-off contact allows the machine to be switched on remotely. Illuminated control selector. Possibility of remote display for machine regulation.

PAINT/COATING

Standard colour: RAL 7035 textured.

MAIN ACCESSORIES (ref. page 189)

- BA - Mechanical bypass valve protecting the pump
- HR - Fluid heating element
- LTA - Operation at low ambient temperatures
- FP - Polyurethane air filter
- RU - Castors

TD - Differential fluid temperature management (two sensors)

- HIGH-pressure pump version "H" - 5 bar.
- Non-standard paint/coating
- Satin AISI 304 stainless steel framework

STRUCTURE

In powder-coated steel sheet, RAL 7035 textured finish. Easily removed panels

COMPRESSOR

Hermetic scroll compressor (connected in tandem), cooled by the refrigerant, complete with thermal cut-out. Case heating element for oil. Electronic management coolant injection valve. Stepped cooling power regulation, 2 steps.

REFRIGERATION CIRCUIT

Complete with charging port, drier filter, liquid receiver, thermostatic valve, solenoid valve, liquid viewing port, high- and low-pressure pressure switch, intake oil separator, R404A refrigerant. Solenoid valve for liquid injection. High- and low-pressure gas pressure gauge.

Dimensions

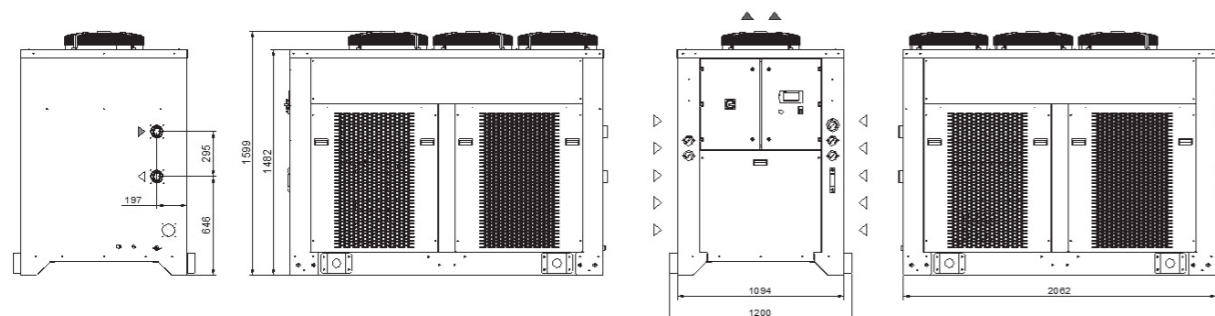

Model		LCWB5	LCWC4
Rated Cooling Capacity*	W	24100	34800
Ambient temperature operating limits	°C	+5 - +48	
Settable fluid temperature range	°C	-30 - -5	
Fluid type		Water + Ethylene Glycol 50%	
Temperature precision	K	+/-1	
Refrigerant gas	HFC	R404A	
Power supply			
Supply voltage	V ph Hz	400V (+/-10%) 3ph 50Hz	
Secondary supply voltage	V	24 V AC	
Digital thermostat		TX200	
Compressor			
Compressor type		Scroll	
Quantity - Number of circuits	no.	4 - 2	6 - 2
Max. power draw	kW	56.0	84.0
Max. current draw	A	94.0	141.5
Axial Fan			
Compressor type		Axial	
Quantity	no.	3	
Air flow rate	m ³ /h	17000	
Max. power draw	kW	2.1	
Max. current draw	A	4.2	
Centrifugal Fan (optional)			
Fan type		Centrifugal	
Quantity	no.	3	
Air flow rate	m ³ /h	17000	
Available head	Pa	260	
Max. power draw	kW	4.5	
Max. current draw	A	9.0	
Standard Pump			
Pump type		Centrifugal	
Quantity	no.	1	
Nominal/max fluid flow rate	l/min	100.0 - 300.0	150.0 - 300.0
Nominal available head	bar	3.4	3.1
Available power draw	kW	2.3	
Max. current draw	A	4.9	
High-Pressure Pump (optional)			
Pump type		Centrifugal	
Quantity	no.	1	
Nominal available head	bar	5.4	5.1
Max. power draw	kW	3.7	
Max. current draw	A	6.3	
Storage tank capacity	l	160	
IN/OUT liquid connections	inch	2"	
Net weight (approximate)***	kg	650	720
Width	mm	1094	
Depth	mm	2062	
Height	mm	1599	
Sound pressure level**	dB(A)	72	74
IP rating	IP	44	

* Data relating to operation under the following conditions: intake/outlet temperature -20/-25°C, water with 50% glycol, ambient temperature 32°C. Cooling power refers to the evaporator unit.

** Sound pressure level, measured in a free hemispherical field at a distance of 1 m from the machine and 1.5 metres from the ground, per ISO 3746.

*** Weight includes pallets and packaging (where provided for), with refrigerant charge, storage tank empty, axial fans.

**** The electrical data refer to cos φ = 0.8.

Correction factors for calculating the cooling power														
Water outlet temperature	Fw	°C	-30	-28	-26	-25	-22	-20	-18	-16	-14	-12	-10	-5
		factor	0.75	0.85	0.95	1.00	1.1	1.20	1.30	1.42	1.54	1.64	1.76	1.80
Ambient Temperature	Fa	°C				15	20	25	32	35	40	48		
		factor				1.16	1.10	1.05	1.00	0.97	0.91	0.84		
Percentage glycol by weight	Fg	%										50		
		factor										1.00		
Cooling power = Nominal cooling power x Fw x Fa x Fg														



TCO

Industrial oil chillers

The new range of **texa industries** chillers for oil, specifically designed and manufactured for cooling hydraulic control units and motors of any power.



TCO08-19 Minichiller

Industrial oil chillers

COOLING CAPACITY

900-1100 - 1600-1900 - 2200-2550 W



AXIAL FAN

Axial fan, complete with electrical protection and safety grille.

HYDRAULIC CIRCUIT

Hydraulic circuit with gear pump without tank, with maximum available pressure 20 bar, 0-25 bar pressure gauge, regulation temperature sensor. Hydraulic safety with safety low- and high-pressure pressure switch.

ELECTRICAL PANEL

With main breaker, fused motor protection with LED visual fault indicator, voltage presence light.

MANAGEMENT AND CONTROL

The TX110 control unit manages the chiller's operation, providing warnings including high/low temperature alarms and a general serious fault alarm, with the display indicating if this refers to the refrigeration or hydraulic circuit. An on-off contact allows the machine to be switched on remotely. Control disconnect switch for switching on the machine.

PAINT/COATING

Standard colour: RAL 7035 textured.

MAIN ACCESSORIES (ref. page 189)

LTA - Operation at low ambient temperatures

FP - Polyurethane air filter

RU - Castors

TD - Differential fluid temperature management (two sensors)

BGC - Hot gas bypass for +/- 1 K temperature precision

FL - Customer flow switch

- Non-standard paint/coating

- Satin AISI 304 stainless steel framework

STRUCTURE

In powder-coated steel sheet, RAL 7035 textured finish. Easily removed panels

COMPRESSOR

Hermetic reciprocating compressor, cooled by the refrigerant, complete with thermal cut-out.

REFRIGERATION CIRCUIT

Complete with charging port, drier filter, expansion valve, high- and low-pressure safety pressure switch, R134a refrigerant.

EVAPORATOR

Brazed stainless-steel plate model.

AIR CONDENSER

Finned high-efficiency copper tube condensing coil, complete with safety grille.

Dimensions

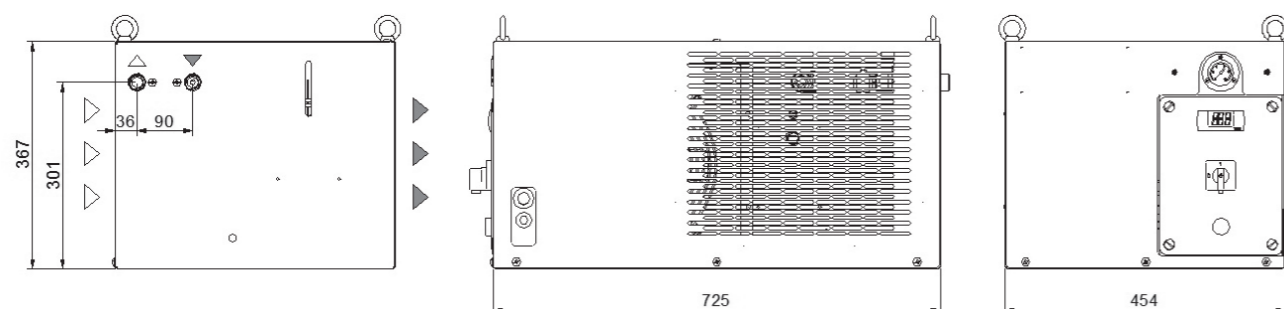

Model		TCO08		TCO12		TCO19	
		50Hz	60Hz	50Hz	60Hz	50Hz	60Hz
Rated Cooling Capacity*	W	900	1100	1600	1900	2200	2550
Ambient temperature operating limits	°C	+15 - +45					
Settable oil temperature range	°C	+25 - +40					
Fluid type		ISO VG 32					
Temperature precision	K	+/-2					
Refrigerant gas	HFC	R134a					
Power supply							
Supply voltage	V ph Hz	230V (+/-10%) 1ph 50/60Hz					
Secondary supply voltage	V AC	230					
Digital thermostat		TX110					
Compressor							
Compressor type		Reciprocating					
Quantity - Number of circuits	no.	1 - 1					
Max. power draw	kW	0.5	0.6	0.7	1.1	1.0	1.15
Max. current draw	A	2.8	3.1	4.1	4.3	6.0	6.5
Axial Fan							
Fan type		Axial					
Quantity	no.	1		1		1	
Air flow rate	m ³ /h	1000		1000		1000	
Max. power draw	W	150	190	150	190	150	190
Max. current draw	A	0.66	0.85	0.66	0.85	0.66	0.85
Standard Pump							
Pump type		Gear pump					
Quantity	no.	1		1		1	
Nominal fluid flow rate	l/min	10		10		10	
Nominal available head	bar	20		20		20	
Max. power draw	kW	0.55		0.55		0.55	
Max. current draw	A	4.0	4.2	4.0	4.2	4.0	4.2
Storage tank capacity (optional)	l	10					
IN/OUT liquid connections	inch	1/2"					
Net weight (approximate)***	kg	59		61		63	
Width	mm	725					
Depth	mm	454					
Height	mm	367					
Sound pressure level**	dB(A)	56		56		56	
IP rating	IP	44					

* Data relating to operation under the following conditions: intake/outlet temperature 40/30°C, ISO VG 32 oil, ambient temperature 32°C. Cooling power refers to the evaporator unit.

** Sound pressure level at 50Hz, measured in a free hemispherical field at a distance of 1 m from the machine and 1.5 metres from the ground, per ISO 3746.

*** Weight includes pallets and packaging (where provided for), with refrigerant charge, without storage tank and axial fans.

**** The electrical data refer to cos φ = 0.8.

Correction factors for calculating the cooling power												
Oil outlet temperature	Fo	°C	20	25	30	35						
		factor	0.82	0.92	1	1.05						
Ambient Temperature	Fa	°C				15	20	25	32	35	40	45
		factor				1.16	1.1	1.05	1	0.97	0.91	0.84
Oil type	Ft	type	ISO VG 10		ISO VG 22		ISO VG 32		ISO VG 46		ISO VG 68	
		factor	1.15		1.1		1		0.9		0.82	
Cooling power = Nominal cooling power x Fo x Fa x Ft												

TCO31-41 Minichiller HP

Industrial oil chillers

COOLING CAPACITY

3000/3450 - 3900/4450 W



AXIAL FAN

Axial fan, complete with thermal cut-out and safety grille.

HYDRAULIC CIRCUIT

Hydraulic circuit with gear pump without tank, with maximum available pressure 20 bar, 0-25 bar pressure gauge, regulation temperature sensor. Hydraulic safety with safety low- and high-pressure pressure switch.

ELECTRICAL PANEL

With main breaker, fused motor protection with LED visual fault indicator, voltage presence light.

MANAGEMENT AND CONTROL

The TX110 control unit manages the chiller's operation, providing warnings including high/low temperature alarms and a general serious fault alarm, with the display indicating if this refers to the refrigeration or hydraulic circuit. An on-off contact allows the machine to be switched on remotely. Control disconnect switch for switching on the machine.

PAINT/COATING

Standard colour: RAL 7035 textured.

MAIN ACCESSORIES (ref. page 189)

LTA - Operation at low ambient temperatures

FP - Polyurethane air filter

RU - Castors

TD - Differential fluid temperature management (two sensors)

BGC - Hot gas bypass for +/- 1 K temperature precision

FL - Customer flow switch

- Non-standard paint/coating

- Satin AISI 304 stainless steel framework

STRUCTURE

In powder-coated steel sheet, RAL 7035 textured finish. Easily removed panels

COMPRESSOR

Hermetic reciprocating compressor, cooled by the refrigerant, complete with thermal cut-out.

REFRIGERATION CIRCUIT

Complete with charging port, drier filter, expansion valve, high- and low-pressure safety pressure switch, thermostatic valve. R134a refrigerant.

EVAPORATOR

Brazed stainless-steel plate model.

AIR CONDENSER

Finned high-efficiency copper tube condensing coil, complete with safety grille.

Dimensions

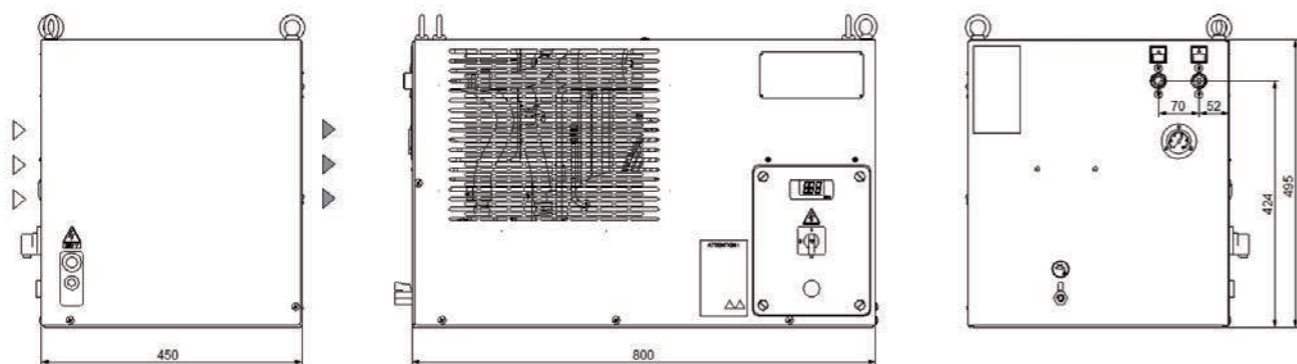

Model		TCO31		TCO41	
		50Hz	60Hz	50Hz	60Hz
Rated Cooling Capacity*	W	3000	3450	3900	4450
Ambient temperature operating limits	°C	+15 - +45			
Settable oil temperature range	°C	+25 - +40			
Fluid type		ISO VG 32			
Temperature precision	K	+/-2			
Refrigerant gas	HFC	R134a			
Power supply					
Supply voltage	V ph Hz	230V (+/-10%) 1ph 50/60Hz			
Secondary supply voltage	V AC	230			
Digital thermostat		TX110			
Compressor					
Compressor type		Reciprocating			
Quantity - Number of circuits	no.	1 - 1			
Max. power draw	kW	1.15	1.5	1.6	1.92
Max. current draw	A	6.1	8.1	7.2	8.4
Axial Fan					
Fan type		Axial			
Quantity	no.	1		1	
Air flow rate	m ³ /h	2300	2650	2300	2650
Max. power draw	W	180	250	180	250
Max. current draw	A	0.81	1.1	0.81	1.1
Standard Pump					
Pump type		Gear pump			
Quantity	no.	1			
Nominal fluid flow rate	l/min	10		10	
Nominal available head	bar	20		20	
Max. power draw	kW	0.55		0.55	
Max. current draw	A	4.0	4.2	4.0	4.2
IN/OUT liquid connections					
IN/OUT liquid connections	inch	1/2"			
Net weight (approximate)***	kg	74		75	
Width	mm	800			
Depth	mm	450			
Height	mm	495			
Sound pressure level**	dB(A)	57	60	57	60
IP rating	IP	44			

* Data relating to operation under the following conditions: intake/outlet temperature 40/30°C, ISO VG 32 oil, ambient temperature 32°C. Cooling power refers to the evaporator unit.

** Sound pressure level at 50Hz, measured in a free hemispherical field at a distance of 1 m from the machine and 1.5 metres from the ground, per ISO 3746.

*** Weight includes pallets and packaging (where provided for), with refrigerant charge, without storage tank and axial fans.

**** The electrical data refer to $\cos \phi = 0.8$.

Correction factors for calculating the cooling power												
Oil outlet temperature	Fo	°C	20	25	30	35						
		factor	0.82	0.92	1	1.05						
Ambient Temperature	Fa	°C				15	20	25	32	35	40	45
		factor				1.16	1.1	1.05	1	0.97	0.91	0.84
Oil type	Ft	type	ISO VG 10		ISO VG 22		ISO VG 32		ISO VG 46		ISO VG 68	
		factor	1.15		1.1		1		0.9		0.82	
Cooling power = Nominal cooling power x Fo x Fa x Ft												

TCO15-36 Size 1

Industrial oil chillers

COOLING CAPACITY

1600-1900 - 2200-2550 - 3300-3900 W



AXIAL FAN

Axial fan, complete with thermal cut-out and safety grille.

HYDRAULIC CIRCUIT

Hydraulic circuit with gear pump without tank, with maximum available pressure 20 bar, pressure limiting valve calibrated at 10 bar, 0-25 bar pressure gauge, regulation temperature sensor. Hydraulic safety with safety low- and high-pressure pressure switch.

ELECTRICAL PANEL

With main disconnect switch, fused motor protection.

MANAGEMENT AND CONTROL

The TX110 control unit manages the chiller's operation, providing warnings including high/low temperature alarms and a general serious fault alarm, with the display indicating if this refers to the refrigeration or hydraulic circuit. An on-off contact allows the machine to be switched on remotely. Control disconnect switch for switching on the machine.

PAINT/COATING

Standard colour: RAL 7035 textured.

MAIN ACCESSORIES (ref. page 189)

- HR - Oil heating element
- LTA - Operation at low ambient temperatures
- FP - Polyurethane air filter
- RU - Castors
- TD - Differential fluid temperature management (two sensors)
- BGC - Hot gas bypass for +/- 1 K temperature precision
- FL - Customer flow switch
- Non-standard paint/coating
- Satin AISI 304 stainless steel framework

STRUCTURE

In powder-coated steel sheet, RAL 7035 textured finish. Easily removed panels

COMPRESSOR

Hermetic reciprocating compressor, cooled by the refrigerant, complete with electrical protection.

REFRIGERATION CIRCUIT

Complete with charging port, drier filter, thermostatic valve, high- and low-pressure pressure switch, R134a refrigerant.

EVAPORATOR

Brazed stainless-steel plate model.

AIR CONDENSER

Finned high-efficiency copper tube condensing coil, complete with safety grille.

Dimensions

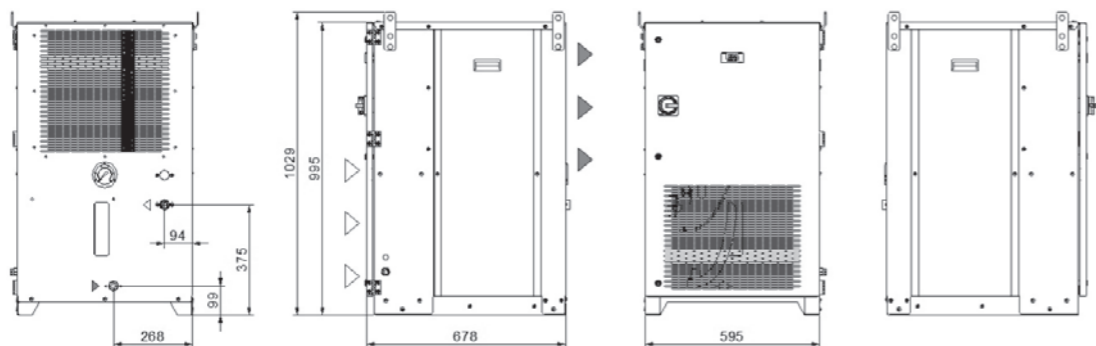

Model		TCO15		TCO22		TCO36	
		50Hz	60Hz	50Hz	60Hz	50Hz	60Hz
Rated Cooling Capacity*	W	1600	1900	2200	2550	3300	3900
Ambient temperature operating limits	°C	+15 - +45					
Settable oil temperature range	°C	+25 - +40					
Fluid type		ISO VG 32					
Temperature precision	K	+/-2					
Refrigerant gas	HFC	R134a					
Power supply							
Supply voltage	V ph Hz	230V (+/-10%) 1ph 50/60Hz					
Secondary supply voltage	V AC	230					
Digital thermostat		TX110					
Compressor							
Compressor type		Reciprocating					
Quantity - Number of circuits	no.	1 - 1					
Max. power draw	kW	1.03	1.06	1.15	1.5	1.73	2.2
Max. current draw	A	5.6	5.8	6.1	8.1	9.4	12
Axial Fan							
Fan type		Axial					
Quantity	no.	1					
Air flow rate	m ³ /h	2300 - 2650		2300 - 2650		2300 - 2650	
Max. power draw	kW	0.18	0.25	0.18	0.25	0.18	0.25
Max. current draw	A	0.81	1.1	0.81	1.1	0.81	1.1
Centrifugal Fan (optional)							
Fan type		Centrifugal					
Quantity	no.	1					
Air flow rate	m ³ /h	2100 - 2400		2100 - 2400		2100 - 2400	
Available head	Pa	250					
Max. power draw	kW	0.15	0.21	0.15	0.21	0.15	0.21
Max. current draw	A	0.35	0.37	0.35	0.37	0.35	0.37
Standard Pump							
Pump type		Gear pump					
Quantity	no.	1		1		1	
Nominal fluid flow rate	l/min	10		10		10	
Nominal available head	bar	20		20		20	
Max. power draw	kW	0.55		0.55		0.55	
Max. current draw	A	4.0	4.2	4.0	4.2	4.0	4.2
Storage tank capacity (optional)	l	30					
IN/OUT liquid connections	inch	3/4"					
Net weight (approximate)***	kg	130		132		132	
Width	mm	595					
Depth	mm	678					
Height	mm	995					
Sound pressure level**	dB(A)	57 - 60		57 - 60		57 - 60	
IP rating	IP	44					

* Data relating to operation under the following conditions: intake/outlet temperature 40/30°C, ISO VG 32 oil, ambient temperature 32°C. Cooling power refers to the evaporator unit.

** Sound pressure level at 50Hz, measured in a free hemispherical field at a distance of 1 m from the machine and 1.5 metres from the ground, per ISO 3746.

*** Weight includes pallets and packaging (where provided for), with refrigerant charge, without storage tank and axial fans.

**** The electrical data refer to cos φ = 0.8.

Correction factors for calculating the cooling power												
Oil outlet temperature	Fo	°C	20	25	30	35						
		factor	0.82	0.92	1	1.05						
Ambient Temperature	Fa	°C				15	20	25	32	35	40	45
		factor				1.16	1.1	1.05	1	0.97	0.91	0.84
Oil type	Ft	type	ISO VG 10		ISO VG 22		ISO VG 32		ISO VG 46		ISO VG 68	
		factor	1.15		1.1		1		0.9		0.82	
Cooling power = Nominal cooling power x Fo x Fa x Ft												

TCO22-55 Size 1 Three Phase

Industrial oil chillers

COOLING CAPACITY

2200 - 3300 - 4400 - 5300 W



AXIAL FAN

Axial fan, complete with thermal cut-out and safety grille

HYDRAULIC CIRCUIT

Hydraulic circuit with gear pump without tank, with maximum available pressure 20 bar, pressure limiting valve calibrated at 10 bar, 0-25 bar pressure gauge, regulation temperature sensor. Hydraulic safety with safety low- and high-pressure pressure switch.

ELECTRICAL PANEL

With main disconnect switch, relay motor protection, phase sequence relays.

MANAGEMENT AND CONTROL

The TX110 control unit manages the chiller's operation, providing warnings including high/low temperature alarms and a general serious fault alarm, with the display indicating if this refers to the refrigeration or hydraulic circuit. An on-off contact allows the machine to be switched on remotely. Control disconnect switch for switching on the machine.

PAINT/COATING

Standard colour: RAL 7035 textured.

MAIN ACCESSORIES (ref. page 189)

- HR - Oil heating element
- LTA - Operation at low ambient temperatures
- FP - Polyurethane air filter
- RU - Castors
- TD - Differential fluid temperature management (two sensors)
- BGC - Hot gas bypass for +/- 1 K temperature precision
- FL - Customer flow switch
- Non-standard paint/coating
- Satin AISI 304 stainless steel framework

STRUCTURE

In powder-coated steel sheet, RAL 7035 textured finish. Easily removed panels

COMPRESSOR

Hermetic reciprocating compressor, cooled by the refrigerant, complete with thermal cut-out.

REFRIGERATION CIRCUIT

Complete with charging port, drier filter, thermostatic valve, high- and low-pressure pressure switch, R134a refrigerant.

EVAPORATOR

With brazed stainless-steel plates with protection against freezing.

AIR CONDENSER

Finned high-efficiency copper tube condensing coil, complete with safety grille.

Dimensions

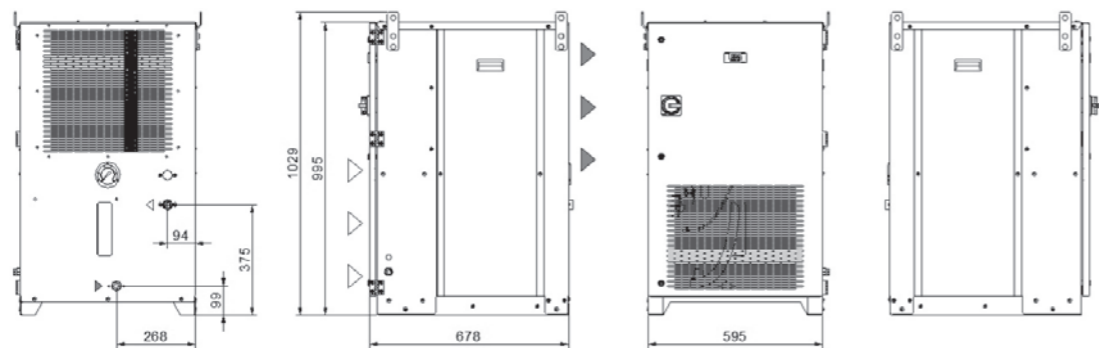

Model		TCO22	TCO36	TCO44	TCO55
Rated Cooling Capacity*	W	2200	3300	4400	5300
Ambient temperature operating limits	°C	+15 - +45			
Settable oil temperature range	°C	+25 - +40			
Fluid type		ISO VG 32			
Temperature precision	K	+/-2			
Refrigerant gas	HFC	R134a			
Power supply					
Supply voltage	V ph Hz	400V (+/-10%) 3ph 50Hz			
Secondary supply voltage	V AC	230			
Digital thermostat		TX110			
Compressor					
Compressor type		Reciprocating			
Quantity - Number of circuits	no.	1 - 1			
Max. power draw	kW	1.50	1.72	2.32	2.61
Max. current draw	A	2.71	3.10	4.2	4.7
Axial Fan					
Fan type		Axial			
Quantity	no.	1	1	1	1
Air flow rate	m ³ /h	2300	2300	2050	2050
Available head	Pa	250			
Max. power draw	kW	0.18	0.18	0.18	0.18
Max. current draw	A	0.81	0.81	0.81	0.81
Centrifugal Fan (optional)					
Fan type		Centrifugal			
Quantity	no.	1	1	1	1
Air flow rate	m ³ /h	2100 - 2400	2100 - 2400	2100 - 2400	2100 - 2400
Max. power draw	W	145 - 205	145 - 205	145 - 205	145 - 205
Max. current draw	A	0.35 - 0.37	0.35 - 0.37	0.35 - 0.37	0.35 - 0.37
Standard Pump					
Pump type		Gear pump			
Quantity	no.	1	1	1	1
Nominal fluid flow rate	l/min	10	10	20	20
Nominal available head	bar	20	20	20	20
Max. power draw	kW	0.75	0.75	1.1	1.1
Max. current draw	A	1.7	1.7	2.6	2.6
Storage tank capacity (optional)	l	30			
IN/OUT liquid connections	inch	3/4"			
Net weight (approximate)***	kg	132	134	136	138
Width	mm	595			
Depth	mm	678			
Height	mm	995			
Sound pressure level**	dB(A)	57	57	57	57
IP rating	IP	44			

* Data relating to operation under the following conditions: intake/outlet temperature 40/30°C, ISO VG 32 oil, ambient temperature 32°C. Cooling power refers to the evaporator unit.

** Sound pressure level, measured in a free hemispherical field at a distance of 1 m from the machine and 1.5 metres from the ground, per ISO 3746.

*** Weight includes pallets and packaging (where provided for), with refrigerant charge, without storage tank and axial fans.

**** The electrical data refer to cos φ = 0.8.

Correction factors for calculating the cooling power												
Oil outlet temperature	Fo	°C	20	25	30	35						
		factor	0.82	0.92	1	1.05						
Ambient Temperature	Fa	°C				15	20	25	32	35	40	45
		factor				1.16	1.1	1.05	1	0.97	0.91	0.84
Oil type	Ft	type	ISO VG 10		ISO VG 22		ISO VG 32		ISO VG 46		ISO VG 68	
		factor	1.15		1.1		1		0.9		0.82	
Cooling power = Nominal cooling power x Fo x Fa x Ft												

TCO56-A0 Size 2

Industrial oil chillers

COOLING CAPACITY

6000 - 8100 - 9200 - 10900 W



AIR CONDENSER

Finned high-efficiency copper tube condensing coil, complete with safety grille.

AXIAL FAN

Axial fan, complete with thermal cut-out and safety grille.

HYDRAULIC CIRCUIT

Hydraulic circuit with gear pump without tank, with maximum available pressure 20 bar, pressure limiting valve calibrated at 10 bar, 0-25 bar oil pressure gauge, regulation sensor.

ELECTRICAL PANEL

With main disconnect switch, relay motor protection, phase sequence relays.

MANAGEMENT AND CONTROL

The TX200 control unit manages the operation of the chiller and provides complete operator alarm diagnostics. An on-off contact allows the machine to be switched on remotely. Illuminated control selector. Possibility of remote display for machine regulation.

PAINT/COATING

Standard colour: RAL 7035 textured.

STRUCTURE

In powder-coated steel sheet, RAL 7035 textured finish. Easily removed panels

COMPRESSOR

Hermetic scroll compressor, cooled by the refrigerant, complete with thermal cut-out.

REFRIGERATION CIRCUIT

Complete with charging port, liquid receiver, drier filter, thermostatic valve, high- and low-pressure pressure switch, R134a refrigerant.

EVAPORATOR

With brazed stainless-steel plates and temperature sensor for protection against freezing.

MAIN ACCESSORIES (ref. page 189)

- HR - Oil heating element
- LTA - Operation at low ambient temperatures
- FP - Polyurethane air filter
- RU - Castors
- TD - Differential fluid temperature management (two sensors)
- BGC - Hot gas bypass for +/- 1 K temperature precision
- FL - Customer flow switch
- Non-standard paint/coating
- Satin AISI 304 stainless steel framework

Model		TCO56	TCO70	TCO91	TCOA0
Rated Cooling Capacity*	W	6000	8100	9200	10900
Ambient temperature operating limits	°C	+15 - +45			
Settable oil temperature range	°C	+25 - +40			
Fluid type		ISO VG 32			
Temperature precision	K	+/-2			
Refrigerant gas	HFC	R134a			
Power supply					
Supply voltage	V ph Hz	400V (+/-10%) 3ph 50Hz			
Secondary supply voltage	V	230-24 V AC			
Digital thermostat		TX200			
Compressor					
Compressor type		Scroll			
Quantity - Number of circuits	no.	1 - 1			
Max. power draw	kW	3.7	3.9	4.4	4.6
Max. current draw	A	5.4	6.7	7.2	7.5
Axial Fan					
Fan type		Axial			
Quantity	no.	1	1	1	1
Air flow rate	m ³ /h	2800	2800	2800	2800
Max. power draw	W	130	130	130	130
Max. current draw	A	0.6	0.6	0.6	0.6
Centrifugal Fan (optional)					
Fan type		Centrifugal			
Quantity	no.	1			
Air flow rate	m ³ /h	2800			
Available head	Pa	250		230	
Max. power draw	kW	0.60			
Max. current draw	A	2.3			
Standard Pump					
Pump type		Gear pump			
Quantity	no.	1	1	1	1
Nominal fluid flow rate	l/min	20	20	40	40
Nominal available head	bar	20	20	20	20
Max. power draw	kW	1.1	1.1	1.9	1.9
Max. current draw	A	3	3	4.6	4.6
Storage tank capacity (optional)					
Storage tank capacity (optional)	l	60			
IN/OUT liquid connections	inch	3/4"			
Net weight (approximate)***	kg	145	155	175	185
Width	mm	681			
Depth	mm	805			
Height	mm	1236			
Sound pressure level**	dB(A)	60	60	60	60
IP rating	IP	44			

* Data relating to operation under the following conditions: intake/outlet temperature 40/30°C, ISO VG 32 oil, ambient temperature 32°C. Cooling power refers to the evaporator unit.

** Sound pressure level, measured in a free hemispherical field at a distance of 1 m from the machine and 1.5 metres from the ground, per ISO 3746.

*** Weight includes pallets and packaging (where provided for), with refrigerant charge, without storage tank and axial fans.

**** The electrical data refer to $\cos \phi = 0.8$.

Dimensions

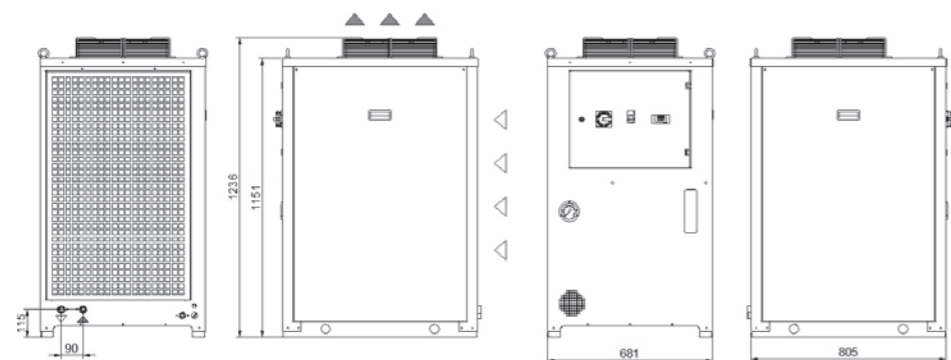

Correction factors for calculating the cooling power

Oil outlet temperature	Fo	°C	20	25	30	35						
		factor	0.82	0.92	1	1.05						
Ambient Temperature	Fa	°C				15	20	25	32	35	40	45
		factor				1.16	1.1	1.05	1	0.97	0.91	0.84
Oil type	Ft	type	ISO VG 10		ISO VG 22		ISO VG 32		ISO VG 46		ISO VG 68	
		factor	1.15		1.1		1		0.9		0.82	

Cooling power = Nominal cooling power x Fo x Fa x Ft

TCOA2-A9 Size 3

Industrial oil chillers

COOLING CAPACITY

12300 - 16400 - 17800 - 20700 W



AIR CONDENSER

Finned high-efficiency copper tube condensing coil, complete with safety grille.

AXIAL FAN

Axial fan, complete with thermal cut-out and safety grille.

HYDRAULIC CIRCUIT

Hydraulic circuit with screw pump without tank, with maximum available pressure 20 bar, pressure limiting valve calibrated at 10 bar, high- and low-pressure safety pressure switch, 0-25 bar oil pressure gauge, regulation sensor.

ELECTRICAL PANEL

With main disconnect switch, relay motor protection, phase sequence relays.

MANAGEMENT AND CONTROL

The TX200 control unit manages the operation of the chiller and provides complete operator alarm diagnostics. An on-off contact allows the machine to be switched on remotely. Illuminated control selector. Possibility of remote display for machine regulation.

PAINT/COATING

Standard colour: RAL 7035 textured.

STRUCTURE

In powder-coated steel sheet, RAL 7035 textured finish. Easily removed panels

COMPRESSOR

Hermetic scroll compressor, cooled by the refrigerant, complete with thermal cut-out.

REFRIGERATION CIRCUIT

Complete with charging port, liquid receiver, drier filter, thermostatic valve, high- and low-pressure pressure switch, liquid viewing port, solenoid valve, R410a refrigerant.

EVAPORATOR

With brazed stainless-steel plates and temperature sensor for protection against freezing.

MAIN ACCESSORIES (ref. page 189)

- HR - Oil heating element
- LTA - Operation at low ambient temperatures
- FP - Polyurethane air filter
- RU - Castors
- TD - Differential fluid temperature management (two sensors)
- FL - Customer flow switch
- Non-standard paint/coating
- Satin AISI 304 stainless steel framework
- Temperature Precision +/- 1 K

Model		TCOA2	TCOA4	TCOA7	TCOA9
Rated Cooling Capacity*	W	12300	16400	17800	20700
Ambient temperature operating limits	°C	+15 - +45			
Settable oil temperature range	°C	+25 - +40			
Fluid type		ISO VG 32			
Temperature precision	K	+/-2			
Refrigerant gas	HFC	R410A			
Power supply					
Supply voltage	V ph Hz	400V (+/-10%) 3ph 50Hz			
Secondary supply voltage	V	24 V AC			
Digital thermostat		TX200			
Compressor					
Compressor type		Scroll			
Quantity - Number of circuits	no.	1 - 1			
Max. power draw	kW	4.7	6.4	6.6	7.4
Max. current draw	A	9.8	12.1	12.5	14.8
Axial Fan					
Fan type		Axial			
Quantity	no.	1	1	1	1
Air flow rate	m³/h	5700	5700	5700	5700
Max. power draw	kW	0.7	0.7	0.7	0.7
Max. current draw	A	1.4	1.4	1.4	1.4
Centrifugal Fan (optional)					
Fan type		Centrifugal			
Quantity	no.	1	1	1	1
Air flow rate	m³/h	5700	5700	5700	5700
Available head	Pa	250	250	220	220
Max. power draw	kW	1.5	1.5	1.5	1.5
Max. current draw	A	3	3	3	3
Standard Pump					
Pump type		Screw pump			
Quantity	no.	1	1	1	1
Nominal fluid flow rate	l/min	60	60	60	60
Nominal available head	bar	20	20	20	20
Max. power draw	kW	3	3	3	3
Max. current draw	A	4.6	4.6	4.6	4.6
Storage tank capacity (optional)					
Storage tank capacity (optional)	l	150			
IN/OUT liquid connections	inch	1"			
Net weight (approximate)***	kg	240	255	280	295
Width	mm	744			
Depth	mm	1360			
Height	mm	1335			
Sound pressure level**	dB(A)	67	67	67	67
IP rating	IP	44			

* Data relating to operation under the following conditions: intake/outlet temperature 40/30°C, ISO VG 32 oil, ambient temperature 32°C. Cooling power refers to the evaporator unit.

** Sound pressure level, measured in a free hemispherical field at a distance of 1 m from the machine and 1.5 metres from the ground, per ISO 3746.

*** Weight includes pallets and packaging (where provided for), with refrigerant charge, without storage tank and axial fans.

**** The electrical data refer to $\cos \phi = 0.8$.

Dimensions

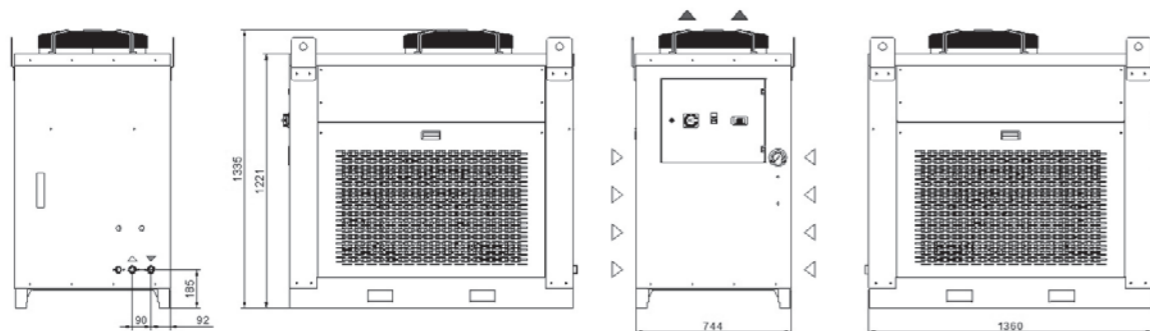

Correction factors for calculating the cooling power

Oil outlet temperature	Fo	°C	20	25	30	35						
		factor	0.82	0.92	1	1.05						
Ambient Temperature	Fa	°C				15	20	25	32	35	40	45
		factor				1.16	1.1	1.05	1	0.97	0.91	0.84
Oil type	Ft	type	ISO VG 10		ISO VG 22		ISO VG 32		ISO VG 46		ISO VG 68	
		factor	1.15		1.1		1		0.9		0.82	

Cooling power = Nominal cooling power x Fo x Fa x Ft

TCOB2-C8 Size 4

Industrial oil chillers

COOLING CAPACITY

23000 - 28300 - 32800 - 37600 W



AIR CONDENSER

Finned high-efficiency copper tube condensing coil, complete with safety grille.

AXIAL FAN

Axial fan, complete with thermal cut-out and safety grille.

HYDRAULIC CIRCUIT

Hydraulic circuit with screw pump without tank, with maximum available pressure 20 bar, pressure limiting valve calibrated at 10 bar, 0-25 bar oil pressure gauge, protective flow switch, regulation sensor.

ELECTRICAL PANEL

With main disconnect switch, relay motor protection, phase sequence relays.

MANAGEMENT AND CONTROL

The TX200 control unit manages the operation of the chiller and provides complete operator alarm diagnostics. An on-off contact allows the machine to be switched on remotely. Illuminated control selector. Possibility of remote display for machine regulation.

PAINT/COATING

Standard colour: RAL 7035 textured.

STRUCTURE

In powder-coated steel sheet, RAL 7035 textured finish. Easily removed panels

COMPRESSOR

Hermetic scroll compressor, cooled by the refrigerant, complete with thermal cut-out.

REFRIGERATION CIRCUIT

Complete with charging port, safety valve, liquid receiver, drier filter, liquid inspection port, solenoid valve, thermostatic valve, high- and low-pressure pressure switch, R410A refrigerant.

EVAPORATOR

With brazed stainless-steel plates and temperature sensor for protection against freezing.

MAIN ACCESSORIES (ref. page 189)

- HR - Oil heating element
- LTA - Operation at low ambient temperatures
- FP - Polyurethane air filter
- RU - Castors
- TD - Differential fluid temperature management (two sensors)
- FL - Customer flow switch.
- Non-standard paint/coating
- Satin AISI 304 stainless steel framework
- Temperature Precision +/- 1 K

Dimensions

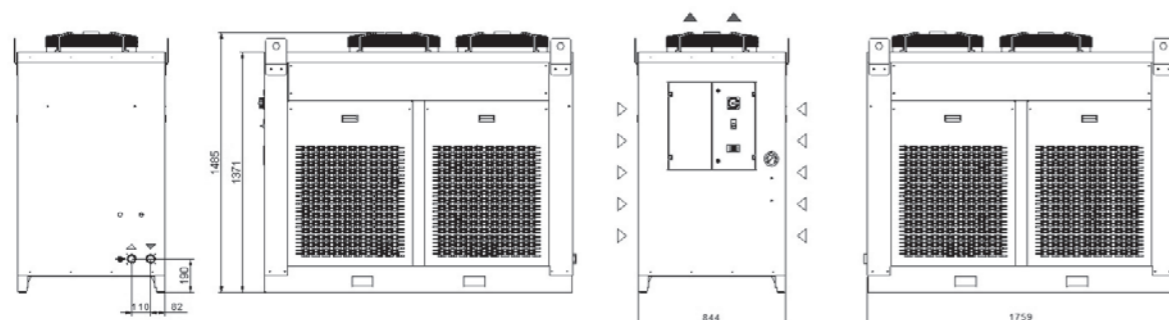

Model		TCOB2	TCOB7	TCOC1	TCOC8
Rated Cooling Capacity*	W	23000	28300	32800	37600
Ambient temperature operating limits	°C	+15 - +45			
Settable oil temperature range	°C	+25 - +40			
Fluid type		ISO VG 32			
Temperature precision	K	+/-2			
Refrigerant gas	HFC	R410A			
Power supply					
Supply voltage	V ph Hz	400V (+/-10%) 3ph 50Hz			
Secondary supply voltage	V	24 V AC			
Digital thermostat		TX200			
Compressor					
Compressor type		Scroll			
Quantity - Number of circuits	no.	1 - 1			
Max. power draw	kW	8.6	10.1	11.6	13.3
Max. current draw	A	15	17.3	18.8	23
Axial Fan					
Fan type		Axial			
Quantity	no.	2	2	2	2
Air flow rate	m³/h	10000	10000	10000	10000
Max. power draw	kW	1.4	1.4	1.4	1.4
Max. current draw	A	2.8	2.8	2.8	2.8
Centrifugal Fan (optional)					
Fan type		Centrifugal			
Quantity	no.	2	2	2	2
Air flow rate	m³/h	10000	10000	10000	10000
Available head	Pa	250	250	220	220
Max. power draw	kW	3	3	3	3
Max. current draw	A	6	6	6	6
Standard Pump					
Pump type		Screw pump			
Quantity	no.	1	1	1	1
Nominal fluid flow rate	l/min	120	120	120	120
Nominal available head	bar	20	20	20	20
Max. power draw	kW	6	6	6	6
Max. current draw	A	10.2	10.2	10.2	10.2
Storage tank capacity (optional)	l	220			
IN/OUT liquid connections	inch	1 1/2"			
Net weight (approximate)***	kg	440	460	500	520
Width	mm	844			
Depth	mm	1759			
Height	mm	1485			
Sound pressure level**	dB(A)	70	70	70	70
IP rating	IP	44			

* Data relating to operation under the following conditions: intake/outlet temperature 40/30°C, ISO VG 32 oil, ambient temperature 32°C. Cooling power refers to the evaporator unit.

** Sound pressure level, measured in a free hemispherical field at a distance of 1 m from the machine and 1.5 metres from the ground, per ISO 3746.

*** Weight includes pallets and packaging (where provided for), with refrigerant charge, without storage tank and axial fans.

**** The electrical data refer to $\cos \phi = 0.8$.

Correction factors for calculating the cooling power

Oil outlet temperature	Fo	°C	20	25	30	35						
		factor	0.82	0.92	1	1.05						
Ambient Temperature	Fa	°C				15	20	25	32	35	40	45
		factor				1.16	1.1	1.05	1	0.97	0.91	0.84
Oil type	Ft	type	ISO VG 10		ISO VG 22		ISO VG 32		ISO VG 46		ISO VG 68	
		factor	1.15		1.1		1		0.9		0.82	

Cooling power = Nominal cooling power x Fo x Fa x Ft

TCOD4-G8 Size 5

Industrial oil chillers

COOLING CAPACITY

41400 - 46100 - 56600 - 65600 - 75200 W



AIR CONDENSER

Finned high-efficiency copper tube condensing coil, complete with safety grille.

AXIAL FAN

Axial fan (connected in tandem for E0, E4), complete with thermal cut-out and safety grille.

LIQUID CIRCUIT

Hydraulic circuit with screw pump without tank, with maximum available pressure 20 bar, pressure limiting valve calibrated at 10 bar, 0-25 bar oil pressure gauge, protective flow switch, temperature regulation sensor.

ELECTRICAL PANEL

With main disconnect switch, relay motor protection, phase sequence relays.

MANAGEMENT AND CONTROL

The TX400 control unit manages the operation of the chiller and provides complete operator alarm diagnostics. An on-off contact allows the machine to be switched on remotely. Illuminated control selector. Dual remote ON-OFF. Ethernet and RS485 connection. Possibility of remote display for machine regulation.

PAINT/COATING

Standard colour: RAL 7035 textured.

STRUCTURE

In powder-coated steel sheet, RAL 7035 textured finish. Easily removed panels

COMPRESSOR

Hermetic scroll compressor, cooled by the refrigerant, complete with thermal cut-out.

REFRIGERATION CIRCUIT

Complete with charging port, safety valve, liquid receiver, drier filter, liquid inspection port, solenoid valve, thermostatic valve, high- and low-pressure pressure switch, R410A refrigerant. Stepped cooling power regulation, 2 steps on models TCW E0-E4-F7-G8.

EVAPORATOR

With brazed stainless-steel plates and temperature sensor for protection against freezing.

MAIN ACCESSORIES (ref. page 189)

- HR - Oil heating element
- LTA - Operation at low ambient temperatures
- FP - Polyurethane air filter
- RU - Castors
- TD - Differential fluid temperature management (two sensors)
- FL - Customer flow switch
- Non-standard paint/coating
- Satin AISI 304 stainless steel framework
- Temperature Precision +/- 1 K

Dimensions

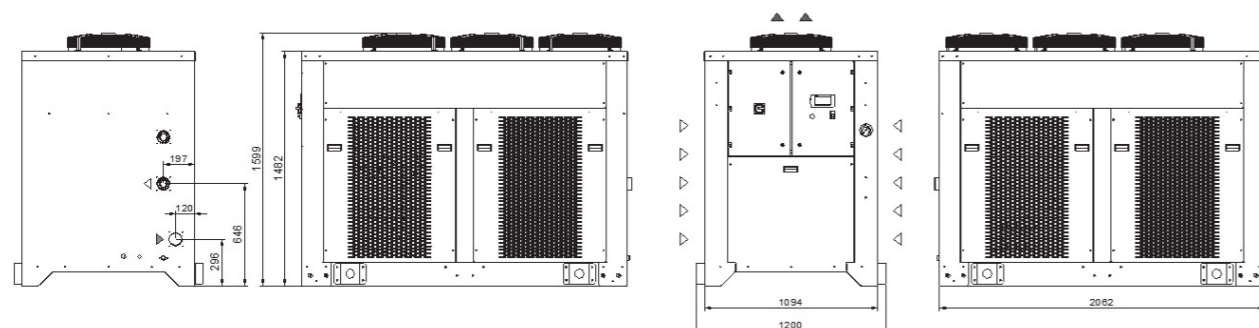

Model		TCOD4	TCOE0	TCOE4	TCOF7	TCOG8
Rated Cooling Capacity*	W	41400	46100	56600	65600	75200
Ambient temperature operating limits	°C	+15 - +45				
Settable fluid temperature range	°C	+25 - +40				
Fluid type		ISO VG - 32				
Temperature precision	K	+/-2				
Refrigerant gas	HFC	R410A				
Power supply						
Supply voltage	V ph Hz	400V (+/-10%) 3ph 50Hz				
Secondary supply voltage	V	24 V AC				
Digital thermostat		TX400				
Compressor						
Compressor type		Scroll				
Quantity - Number of circuits	no.	1 - 1	2 - 1		2 - 2	
Max. power draw	kW	14.8	16.7	20.2	23.2	26.6
Max. current draw	A	25.3	29.8	34.5	37.6	46
Axial Fan						
Fan type		Axial				
Quantity	no.	3	3	3	3	3
Air flow rate	m³/h	17000	17000	17000	17000	17000
Max. power draw	kW	2.1	2.1	2.1	2.1	2.1
Max. current draw	A	4.2	4.2	4.2	4.2	4.2
Centrifugal Fan (optional)						
Fan type		Centrifugal				
Quantity	no.	3	3	3	3	3
Air flow rate	m³/h	17000	17000	17000	17000	17000
Available head	Pa	260	260	260	230	230
Max. power draw	kW	4.5	4.5	4.5	4.5	4.5
Max. current draw	A	9	9	9	9	9
Standard Pump						
Pump type		Screw pump				
Quantity	no.	1	1	1	1	1
Nominal fluid flow rate	l/min	220	220	220	220	220
Nominal available head	bar	10	10	10	10	10
Max. power draw	kW	11	11	11	11	11
Max. current draw	A	19.5	19.5	19.5	19.5	19.5
Storage tank capacity (optional)						
Storage tank capacity (optional)	l	250				
IN/OUT liquid connections	inch	2 1/2"	2 1/2"	2 1/2"	2 1/2"	2 1/2"
Net weight (approximate)***	kg	580	620	660	710	730
Width	mm	1094				
Depth	mm	2062				
Height	mm	1599				
Sound pressure level**	dB(A)	72	72	72	72	72
IP rating	IP	44				

* Data relating to operation under the following conditions: intake/outlet temperature 40/30°C, ISO VG 32 oil, ambient temperature 32°C. Cooling power refers to the evaporator unit.

** Sound pressure level, measured in a free hemispherical field at a distance of 1 m from the machine and 1.5 metres from the ground, per ISO 3746.

*** Weight includes pallets and packaging (where provided for), with refrigerant charge, without storage tank and axial fans.

**** The electrical data refer to $\cos \phi = 0.8$.

Correction factors for calculating the cooling power

Oil outlet temperature	Fo	°C	20	25	30	35						
		factor	0.82	0.92	1	1.05						
Ambient Temperature	Fa	°C				15	20	25	32	35	40	45
		factor				1.16	1.1	1.05	1	0.97	0.91	0.84
Oil type	Ft	type	ISO VG 10		ISO VG 22		ISO VG 32		ISO VG 46		ISO VG 68	
		factor	1.15		1.1		1		0.9		0.82	

Cooling power = Nominal cooling power x Fo x Fa x Ft

TCU

Industrial chillers for contaminated or dirty fluids

With its innovative tube heat exchange system, the TCU range allows dirty fluids to be cooled while guaranteeing the highest levels of performance and the lowest maintenance costs.



TCU15-36 Size 1

Industrial chillers for contaminated or dirty fluids

COOLING CAPACITY

1600-1900 - 2200-2550 - 3300-3900 W



AXIAL FAN

Axial fan, complete with thermal cut-out and safety grille.

FLUID POWER CIRCUIT

Fluid power circuit with centrifugal pump without tank, with maximum available pressure 3 bar, dual oil safety pressure switch, 0-10 bar oil pressure gauge, regulation sensor.

ELECTRICAL PANEL

With main disconnect switch, relay motor protection, phase sequence relays.

MANAGEMENT AND CONTROL

The TX110 control unit manages the chiller's operation, providing warnings including high/low temperature alarms and a general serious fault alarm, with the display indicating if this refers to the refrigeration or fluid power circuit. An on-off contact allows the machine to be switched on remotely. Control disconnect switch for switching on the machine.

PAINT/COATING

Standard colour: RAL 7035 textured.

MAIN ACCESSORIES (ref. page 189)

- HR - Fluid heating element
- LTA - Operation at low ambient temperatures
- FP - Polyurethane air filter
- RU - Castors
- TD - Differential fluid temperature management (two sensors)
- BGC - Hot gas bypass for +/- 1 K temperature precision
- Non-standard paint/coating
- Satin AISI 304 stainless steel framework

STRUCTURE

In powder-coated steel sheet, RAL 7035 textured finish. Easily removed panels

COMPRESSOR

Hermetic reciprocating compressor, cooled by the refrigerant, complete with thermal cut-out.

REFRIGERATION CIRCUIT

Complete with charging port, drier filter, thermostatic valve, high- and low-pressure safety pressure switch, R134a refrigerant.

EVAPORATOR

Tube evaporator with mantle, steel heads and copper heat exchanger tubes, with anti-freezing protection.

AIR CONDENSER

Finned high-efficiency copper tube condensing coil, complete with safety grille.

Dimensions

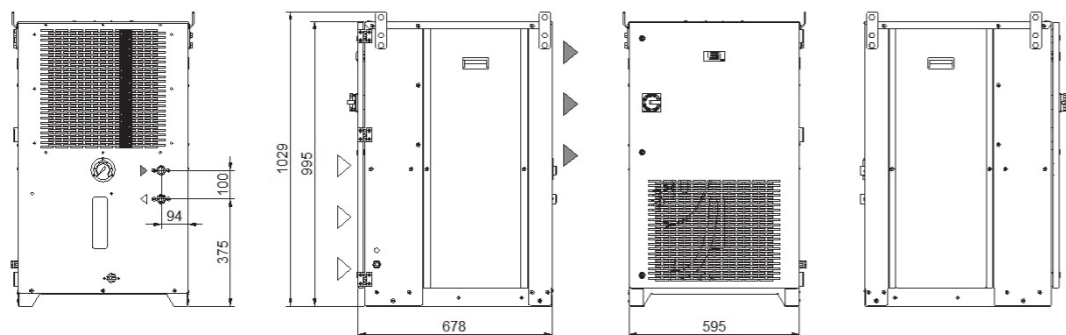

Model	TCU15		TCU22		TCU36		
	50Hz	60Hz	50Hz	60Hz	50Hz	60Hz	
Rated Cooling Capacity*	W	1600	1900	2200	2550	3300	3900
Ambient temperature operating limits	°C	+15 - +45					
Settable fluid temperature range	°C	+25 - +40					
Fluid type		Dirty fluids (oil and mineral oil emulsions)					
Maximum oil impurity size	µm	150					
Temperature precision	K	+/-2					
Refrigerant gas	HFC	R134a					
Power supply							
Supply voltage	V ph Hz	230V (+/-10%) 1ph 50/60Hz					
Secondary supply voltage	V	230					
Digital thermostat		TX110					
Compressor							
Compressor type		Reciprocating					
Quantity - Number of circuits	no.	1 - 1					
Max. power draw	kW	1.03	1.06	1.15	1.5	1.73	2.22
Max. current draw	A	5.6	5.8	6.1	8.1	9.4	12
Axial Fan							
Fan type		Axial					
Quantity	no.	1		1		1	
Air flow rate	m ³ /h	2300 - 2650		2300 - 2650		2300 - 2650	
Max. power draw	W	180	250	180	250	180	250
Max. current draw	A	0.81	1.1	0.81	1.1	0.81	1.1
Centrifugal Fan (optional)							
Fan type		Centrifugal					
Quantity	no.	1		1		1	
Air flow rate	m ³ /h	2100 - 2400		2100 - 2400		2100 - 2400	
Available head	Pa	250					
Max. power draw	kW	0.15	0.21	0.15	0.21	0.15	0.21
Max. current draw	A	0.35	0.37	0.35	0.37	0.35	0.37
Centrifugal Pump							
Pump type		Centrifugal					
Quantity	no.	1		1		1	
Nominal/max fluid flow rate	l/min	14 - 55		14 - 55		18 - 55	
Nominal available head	bar	3.2		3.2		3.0	
Max. power draw	kW	0.67		0.67		0.67	
Max. current draw	A	4.9		4.9		4.9	
IN/OUT liquid connections	inch	3/4"					
Net weight (approximate)***	kg	130		132		132	
Width	mm	595					
Depth	mm	678					
Height	mm	995					
Sound pressure level**	dB(A)	57 - 60		57 - 60		57 - 60	
IP rating	IP	44					

* Data relating to operation under the following conditions: intake/outlet temperature 40/30°C, ISO VG 32 mineral oil, ambient temperature 32°C. Cooling power refers to the evaporator unit.

** Sound pressure level at 50Hz, measured in a free hemispherical field at a distance of 1 m from the machine and 1.5 metres from the ground, per ISO 3746.

*** Weight includes pallets and packaging (where provided for), with refrigerant charge, without storage tank and axial fans.

**** The electrical data refer to $\cos \phi = 0.8$.

Correction factors for calculating the cooling power

Oil outlet temperature	Fo	°C	20	25	30	35					
		factor	0.82	0.92	1	1.05					
Ambient Temperature	Fa	°C			15	20	25	32	35	40	45
		factor			1.16	1.1	1.05	1	0.97	0.91	0.84
Oil type	Ft	type	ISO VG 10		ISO VG 22		ISO VG 32		ISO VG 46		ISO VG 68
		factor	1.15		1.1		1		0.9		0.82

Cooling power = Nominal cooling power x Fo x Fa x Ft

TCU22-55 Size 1 Three Phase

Industrial chillers for contaminated or dirty fluids

COOLING CAPACITY

2200 - 3300 - 4400 - 5300 W



AXIAL FAN

Axial fan, complete with thermal cut-out and safety grille.

FLUID POWER CIRCUIT

Fluid power circuit with centrifugal pump without tank, with maximum available pressure 3 bar, dual oil safety pressure switch, 0-10 bar oil pressure gauge, regulation sensor.

ELECTRICAL PANEL

With main disconnect switch, relay motor protection, phase sequence relays.

MANAGEMENT AND CONTROL

The TX110 control unit manages the chiller's operation, providing warnings including high/low temperature alarms and a general serious fault alarm, with the display indicating if this refers to the refrigeration or fluid power circuit. An on-off contact allows the machine to be switched on remotely. Control disconnect switch for switching on the machine.

PAINT/COATING

Standard colour: RAL 7035 textured.

MAIN ACCESSORIES (ref. page 189)

- HR - Fluid heating element
- LTA - Operation at low ambient temperatures
- FP - Polyurethane air filter
- RU - Castors
- TD - Differential fluid temperature management (two sensors)
- BGC - Hot gas bypass for +/- 1 K temperature precision
- Non-standard paint/coating
- Satin AISI 304 stainless steel framework

STRUCTURE

In powder-coated steel sheet, RAL 7035 textured finish. Easily removed panels

COMPRESSOR

Hermetic reciprocating compressor, cooled by the refrigerant, complete with thermal cut-out.

REFRIGERATION CIRCUIT

Complete with charging port, drier filter, thermostatic valve, high- and low-pressure safety pressure switch, R134a refrigerant.

EVAPORATOR

Tube evaporator with mantle, steel heads and copper heat exchanger tubes, with anti-freezing protection.

AIR CONDENSER

Finned high-efficiency copper tube condensing coil, complete with safety grille.

Dimensions

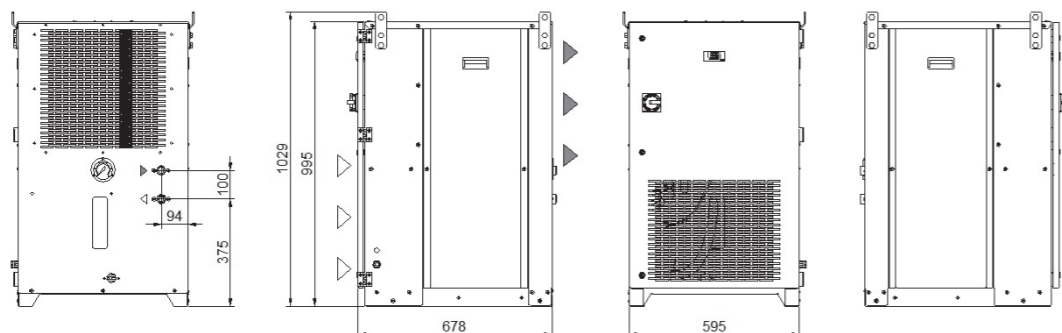

Model		TCU22	TCU36	TCU44	TCU55
Rated Cooling Capacity*	W	2200	3300	4400	5300
Ambient temperature operating limits	°C	+15 - +45			
Settable oil temperature range	°C	+25 - +40			
Fluid type		Dirty fluids (oil and mineral oil emulsions)			
Maximum oil impurity size	µm	150			
Temperature precision	K	+/-2			
Refrigerant gas	HFC	R134a			
Power supply					
Supply voltage	V ph Hz	400V (+/-10%) 3ph 50Hz			
Secondary supply voltage	V	230 V AC			
Digital thermostat		TX110			
Compressor					
Compressor type		Reciprocating			
Quantity	no.	1 - 1			
Max. power draw	kW	1.5	1.72	2.32	2.61
Max. current draw	A	2.7	3.1	4.2	4.7
Axial Fan					
Fan type		Axial			
Quantity	no.	1	1	1	1
Air flow rate	m³/h	2300	2300	2050	2050
Max. power draw	W	180	180	180	180
Max. current draw	A	0.81	0.81	0.81	0.81
Centrifugal Fan (optional)					
Fan type		Centrifugal			
Quantity	no.	1			
Air flow rate	m³/h	2100 - 2400	2100 - 2400	2100 - 2400	2100 - 2400
Available head	Pa	250		230	
Max. power draw	W	145 - 205	145 - 205	145 - 205	145 - 205
Max. current draw	A	0.35 - 0.37	0.35 - 0.37	0.35 - 0.37	0.35 - 0.37
Centrifugal Pump					
Pump type		Centrifugal			
Quantity	no.	1	1	1	1
Nominal fluid flow rate	l/min	14 - 60	18 - 60	24 - 60	30 - 60
Nominal available head	bar	3.2	3.2	3.0	2.8
Max. power draw	kW	0.67	0.67	0.67	0.67
Max. current draw	A	1.6	1.6	1.6	1.6
IN/OUT liquid connections					
IN/OUT liquid connections	inch	3/4"			
Net weight (approximate)***	kg	100	110	135	145
Width	mm	595			
Depth	mm	678			
Height	mm	995			
Sound pressure level**	dB(A)	57	57	57	57
IP rating	IP	44			

* Data relating to operation under the following conditions: intake/outlet temperature 40/30°C, ISO VG 32 mineral oil, ambient temperature 32°C. Cooling power refers to the evaporator unit.

** Sound pressure level, measured in a free hemispherical field at a distance of 1 m from the machine and 1.5 metres from the ground, per ISO 3746.

*** Weight includes pallets and packaging (where provided for), with refrigerant charge, without storage tank and axial fans.

**** The electrical data refer to $\cos \phi = 0.8$.

Correction factors for calculating the cooling power

Oil outlet temperature	Fo	°C	20	25	30	35						
		factor	0.82	0.92	1	1.05						
Ambient Temperature	Fa	°C				15	20	25	32	35	40	45
		factor				1.16	1.1	1.05	1	0.97	0.91	0.84
Oil type	Ft	type	ISO VG 10		ISO VG 22		ISO VG 32		ISO VG 46		ISO VG 68	
		factor	1.15		1.1		1		0.9		0.82	

Cooling power = Nominal cooling power x Fo x Fa x Ft

TCU56-A0 Size 2

Industrial chillers for contaminated or dirty fluids

COOLING CAPACITY

6000 - 8100 - 9200 - 10900 W



AXIAL FAN

Axial fan, complete with thermal cut-out and safety grille.

FLUID POWER CIRCUIT

Fluid power circuit with centrifugal pump without tank, with maximum available pressure 3 bar, dual oil safety pressure switch, 0-10 bar oil pressure gauge, regulation sensor.

ELECTRICAL PANEL

With main disconnect switch, relay motor protection, phase sequence relays.

MANAGEMENT AND CONTROL

The TX200 control unit manages the operation of the chiller and provides complete operator alarm diagnostics. An on-off contact allows the machine to be switched on remotely. Illuminated control selector. Possibility of remote display for machine regulation.

PAINT/COATING

Standard colour: RAL 7035 textured.

MAIN ACCESSORIES (ref. page 189)

HR - Fluid heating element

LTA - Operation at low ambient temperatures

FP - Polyurethane air filter

RU - Castors

TD - Differential fluid temperature management (two sensors)

BGC - Hot gas bypass for +/- 1 K temperature precision

- Non-standard paint/coating

- Satin AISI 304 stainless steel framework

STRUCTURE

In powder-coated steel sheet, RAL 7035 textured finish. Easily removed panels

COMPRESSOR

Hermetic scroll compressor, cooled by the refrigerant, complete with thermal cut-out.

REFRIGERATION CIRCUIT

Complete with charging port, liquid receiver, drier filter, thermostatic valve, high- and low-pressure pressure switch, R134a refrigerant.

EVAPORATOR

Tube evaporator with mantle, steel heads and copper heat exchanger tubes, with anti-freezing protection.

AIR CONDENSER

Finned high-efficiency copper tube condensing coil, complete with safety grille.

Dimensions

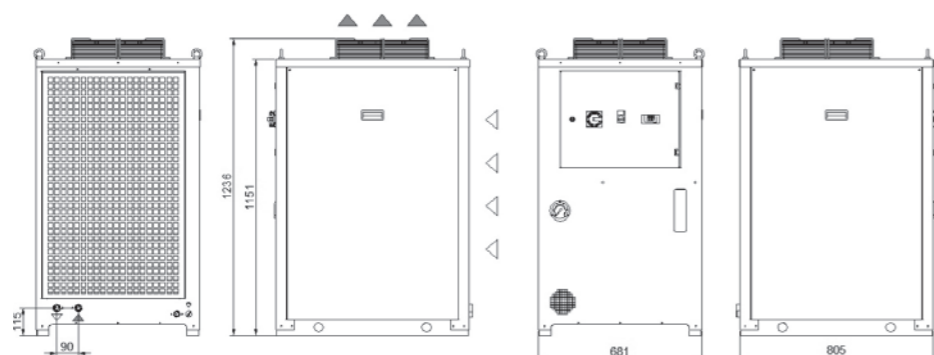

Model		TCU56	TCU70	TCU91	TCUA0
Rated Cooling Capacity*	W	6000	8100	9200	10900
Ambient temperature operating limits	°C	+15 - +45			
Settable oil temperature range	°C	+25 - +40			
Fluid type		Dirty fluids (oil and mineral oil emulsions)			
Maximum oil impurity size	µm	150			
Temperature precision	K	+/-2			
Refrigerant gas	HFC	R134a			
Power supply					
Supply voltage	V ph Hz	400V (+/-10%) 3ph 50Hz			
Secondary supply voltage	V	230-24 V AC			
Digital thermostat		TX200			
Compressor					
Compressor type		Scroll			
Quantity	no.	1	1	1	1
Max. power draw	kW	3.7	3.9	4.4	4.6
Max. current draw	A	5.4	6.7	7.2	7.5
Axial Fan					
Fan type		Axial			
Quantity	no.	1	1	1	1
Air flow rate	m ³ /h	2800	2800	2800	2800
Max. power draw	W	130	130	130	130
Max. current draw	A	0.6	0.6	0.6	0.6
Centrifugal Fan (optional)					
Fan type		Centrifugal			
Quantity	no.	1	1	1	1
Air flow rate	m ³ /h	2800	2800	2800	2800
Available head	Pa	250		230	
Max. power draw	kW	0.6	0.6	0.6	0.6
Max. current draw	A	2.3	2.3	2.3	2.3
Centrifugal Pump					
Pump type		Centrifugal			
Quantity	no.	1	1	1	1
Nominal fluid flow rate	l/min	27.0 - 50.0	36.0 - 50.0	42.0 - 50.0	45.0 - 50.0
Nominal available head	bar	2.4	1.8	1.4	1.3
Max. power draw	kW	1.1	1.1	1.9	1.9
Max. current draw	A	2.2	2.2	2.2	2.2
IN/OUT liquid connections					
IN/OUT liquid connections	inch	1"			
Net weight (approximate)***	kg	145	155	175	185
Width	mm	681			
Depth	mm	805			
Height	mm	1236			
Sound pressure level**	dB(A)	60	60	60	60
IP rating	IP	44			

* Data relating to operation under the following conditions: intake/outlet temperature 40/30°C, ISO VG 32 mineral oil, ambient temperature 32°C. Cooling power refers to the evaporator unit.

** Sound pressure level, measured in a free hemispherical field at a distance of 1 m from the machine and 1.5 metres from the ground, per ISO 3746.

*** Weight includes pallets and packaging (where provided for), with refrigerant charge, without storage tank and axial fans.

**** The electrical data refer to cos φ = 0.8.

Correction factors for calculating the cooling power												
Oil outlet temperature	Fo	°C	20	25	30	35						
		factor	0.82	0.92	1	1.05						
Ambient Temperature	Fa	°C				15	20	25	32	35	40	45
		factor				1.16	1.1	1.05	1	0.97	0.91	0.84
Oil type	Ft	type	ISO VG 10		ISO VG 22		ISO VG 32		ISO VG 46		ISO VG 68	
		factor	1.15		1.1		1		0.9		0.82	
Cooling power = Nominal cooling power x Fo x Fa x Ft												

TCI

Immersion coil chillers

The new TCI range of chillers from **texa industries**, featuring immersion coil evaporators, is **texa industries'** answer to any oil/water cooling requirements for industrial applications.



TCI56-91 Size 2

Immersion coil chillers

COOLING CAPACITY

6000 - 7100 - 8100 - 9650 - 9200 - 11000 W



AIR CONDENSER

Finned high-efficiency copper tube condensing coil, complete with safety grille.

AXIAL FAN

Axial fan, complete with thermal cut-out and safety grille. On request, centrifugal fan for air expulsion ducting.

ELECTRICAL PANEL

With main disconnect switch, fused motor protection.

MANAGEMENT AND CONTROL

The TX110 control unit manages the chiller's operation, providing warnings including high/low temperature alarms and a general serious fault alarm, with the display indicating if this refers to the refrigeration circuit or protection of the immersion coils. An on-off contact allows the machine to be switched on remotely. Control disconnect switch for switching on the machine.

PAINT/COATING

Standard colour: RAL 7035 textured.

MAIN ACCESSORIES (on request, ref. page 189)

- LE - Electric level
- FP - Polyurethane air filter
- TD - Differential fluid temperature management (two sensors)
- BGP - Hot gas bypass for +/- 0.5 K temperature precision
- Agitator for fluid movement
- Non-standard paint/coating
- Satin AISI 304 stainless steel framework
- Design of higher cooling powers with dedicated framework
- Centrifugal fans for condensation air ducting

STRUCTURE

In powder-coated steel sheet, RAL 7035 textured finish. Easily removed panels

COMPRESSOR

Hermetic SCROLL compressor, cooled by the refrigerant, complete with thermal cut-out.

REFRIGERATION CIRCUIT

Complete with charging port, drier filter, thermostatic valve, high- and low-pressure pressure switch, refrigerant gas.

EVAPORATOR

Dual concentric coil in AISI 304 stainless steel. Resin-covered stainless-steel regulation sensor, IP67 rated.

Dimensions

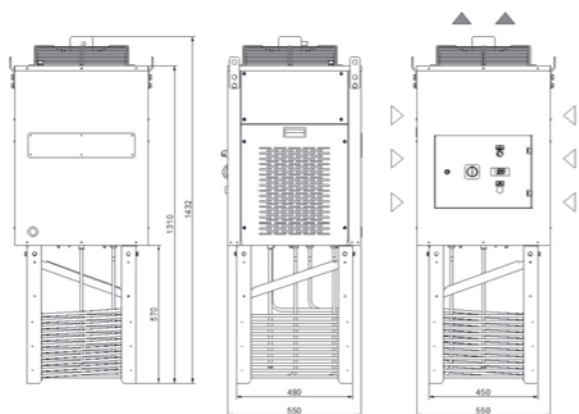

Model		TCI56		TCI70		TCI91	
		50Hz	60Hz	50Hz	60Hz	50Hz	60Hz
Rated Cooling Capacity*	W	6000	7100	8100	9650	9200	11000
Ambient temperature operating limits	°C	-5 - +45					
Settable fluid temperature range	°C	+15 / +25 water or emulsion max 5 cSt - 40°C +20 / +30 mineral oil 32 cSt - 40°C					
Temperature precision	K	+/- 1					
Refrigerant gas	HFC	R134a					
Minimum fluid flow rate (emulsion/oil)	l/min	40 - 60					
Minimum volume in tank (emulsion/oil)	l.	60 - 100					
Power supply							
Supply voltage	V ph Hz	400/460V (+/-10%) 3ph 50/60Hz					
Secondary supply voltage	V	230V-24V AC					
Digital thermostat		TX110					
Compressor							
Compressor type		Scroll					
Quantity - Number of circuits	no.	1 - 1					
Max. power draw	kW	3.7	4.5	4.2	5.1	2.9	3.6
Max. current draw	A	5.4	6.3	7.1	8.0	6.0	6.9
Axial Fan							
Fan type		Axial					
Quantity	no.	1					
Air flow rate	m ³ /h	2000					
Max. power draw	kW	0.18	0.25	0.18	0.25	0.18	0.25
Max. current draw	A	0.81	1.1	0.81	1.1	0.81	1.1
Net weight (approximate)***							
	kg	145		147		150	
Width	mm	550					
Depth	mm	550					
Height	mm	1432					
Sound pressure level**	dB(A)	57		57		57	
IP rating	IP	44					

* Data relates to operation under the following conditions: Ambient temperature 32°C.
** Sound pressure level at 50Hz, measured in a free hemispherical field at a distance of 1 m from the machine and 1.5 metres from the ground, per ISO 3746.
*** Weight includes pallets and packaging (where provided for), with refrigerant charge and axial fans.
**** The electrical data refer to cos φ = 0.8.

Correction factors for calculating the cooling power								
Ambient Temperature	Emulsion	Oil	Cooling capacity					
			15	20	25	30	35	40
32	15	20	4620	5467	6237	7431	7084	8470
	20	25	5460	6461	7371	8782	8372	10010
	25	30	6000	7100	8100	9650	9200	11000
37	15	20	4332	5126	5848	6967	6642	7942
	20	25	5187	6138	7002	8342	7953	9510
	25	30	5700	6745	7695	9168	8740	10450
42	15	20	4066	4811	5489	6539	6234	7454
	20	25	4805	5686	6486	7728	7367	8809
	25	30	5280	6248	7128	8492	8096	9680

TCIA2-A7 Size 3

Immersion coil chillers

COOLING CAPACITY

12300 - 14600 - 16400 - 16200 - 17800 - 20450 W



AIR CONDENSER

Finned high-efficiency copper tube condensing coil, complete with safety grille.

AXIAL FAN

Axial fan, complete with thermal cut-out and safety grille. On request, centrifugal fan for air expulsion ducting.

ELECTRICAL PANEL

With main disconnect switch, fused motor protection.

MANAGEMENT AND CONTROL

The TX110 control unit manages the chiller's operation, providing warnings including high/low temperature alarms and a general serious fault alarm, with the display indicating if this refers to the refrigeration circuit or protection of the immersion coils. An on-off contact allows the machine to be switched on remotely. Control disconnect switch for switching on the machine.

PAINT/COATING

Standard colour: RAL 7035 textured.

MAIN ACCESSORIES (on request, ref. page 189)

- LE - Electric level
- FP - Polyurethane air filter
- TD - Differential fluid temperature management (two sensors)
- BGP - Hot gas bypass for +/- 0.5 K temperature precision
- Agitator for fluid movement
- Non-standard paint/coating
- Satin AISI 304 stainless steel framework
- Design of higher cooling powers with dedicated framework
- Centrifugal fans for condensation air ducting

STRUCTURE

In powder-coated steel sheet, RAL 7035 textured finish. Easily removed panels

COMPRESSOR

Hermetic SCROLL compressor, cooled by the refrigerant, complete with thermal cut-out.

REFRIGERATION CIRCUIT

Complete with charging port, drier filter, thermostatic valve, high- and low-pressure pressure switch, refrigerant gas.

EVAPORATOR

Dual concentric coil in AISI 304 stainless steel. Resin-covered stainless-steel regulation sensor, IP67 rated.

Dimensions

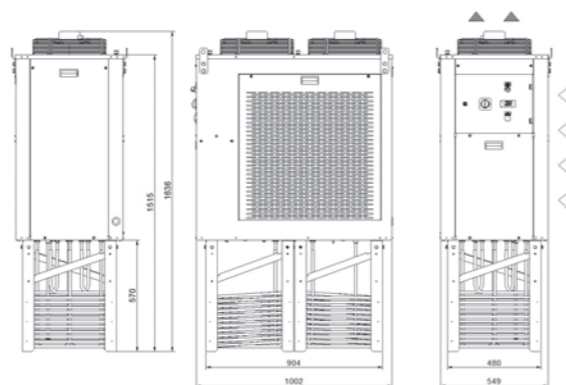

Model	TCIA2		TCIA4		TCIA7		
	50Hz	60Hz	50Hz	60Hz	50Hz	60Hz	
Rated Cooling Capacity*	W	12300	14600	16400	16200	17800	20450
Ambient temperature operating limits	°C	-5 - +45					
Settable fluid temperature range	°C	+15 / +25 water or emulsion max 5 cSt - 40°C +20 / +30 mineral oil 32 cSt - 40°C					
Temperature precision	K	+/- 1					
Refrigerant gas	HFC	R410A					
Minimum fluid flow rate (emulsion/oil)	l/min	80 - 120					
Minimum volume in tank (emulsion/oil)	l.	150 - 250					
Power supply							
Supply voltage	V ph Hz	400/460V (+/-10%) 3ph 50/60Hz					
Secondary supply voltage	V	230V-24V AC					
Digital thermostat		TX110					
Compressor							
Compressor type		Scroll					
Quantity - Number of circuits	no.	1 - 1					
Max. power draw	kW	3.1	3.5	4.0	3.7	4.1	4.7
Max. current draw	A	9.8	9.6	12.1	9.9	12.5	12.1
Axial Fan							
Fan type		Axial					
Quantity	no.	2					
Air flow rate	m ³ /h	4300					
Max. power draw	kW	0.4	0.55	0.4	0.55	0.4	0.55
Max. current draw	A	1.7	2.2	1.7	2.2	1.7	2.2
Net weight (approximate)***							
	kg	215		215		215	
Width	mm	549					
Depth	mm	1002					
Height	mm	1636					
Sound pressure level**	dB(A)	60		60		60	
IP rating	IP	44					

* Data relates to operation under the following conditions: Ambient temperature 32°C.
 ** Sound pressure level at 50Hz, measured in a free hemispherical field at a distance of 1 m from the machine and 1.5 metres from the ground, per ISO 3746.
 *** Weight includes pallets and packaging (where provided for), with refrigerant charge and axial fans.
 **** The electrical data refer to cos φ = 0.8.

Correction factors for calculating the cooling power								
Ambient Temperature	Emulsion	Oil	Cooling capacity					
			15	20	25	30	35	40
32	15	20	9471	11242	12628	12474	13706	15747
	20	25	11193	13286	14924	14742	16198	18610
	25	30	12300	14600	16400	16200	17800	20450
37	15	20	8881	10541	11841	11696	12852	14765
	20	25	10633	12622	14178	14005	15388	17679
	25	30	11685	13870	15580	15390	16910	19428
42	15	20	8334	9893	11113	10977	12061	13857
	20	25	9850	11692	13133	12973	14254	16376
	25	30	10824	12848	14432	14256	15664	17996

SAW

Water-air heat exchangers

The most simple and cost-effective system for cooling of fluids in industrial processes through the ambient air.



SAW10

Water-air heat exchangers

COOLING CAPACITY

1500-1750 W



MANAGEMENT AND CONTROL

Power supply cable: 1.5 m.

PAINT/COATING

Standard colour: RAL 7035 textured.

MAIN ACCESSORIES (ref. page 189)

LE - Electrical level indicator

FP - Polyurethane air filter

TR - Digital regulation thermostat, temperature display complete with NTC sensor

RU - Castors

AV - Vibration damper supports

Others on request

STRUCTURE

In powder-coated steel sheet

AXIAL FAN

Aluminium axial fan, diameter 200 mm.

LIQUID CIRCUIT

Liquid circuit composed entirely of non-ferrous material in contact with the liquid to prevent contamination. Brass electric pump with 3 bar available head with thermal cut-out. Storage tank, complete with filling. Protective water flow switch.

COOLING COIL

Finned aluminium cooling coil with copper tubes.

Dimensions

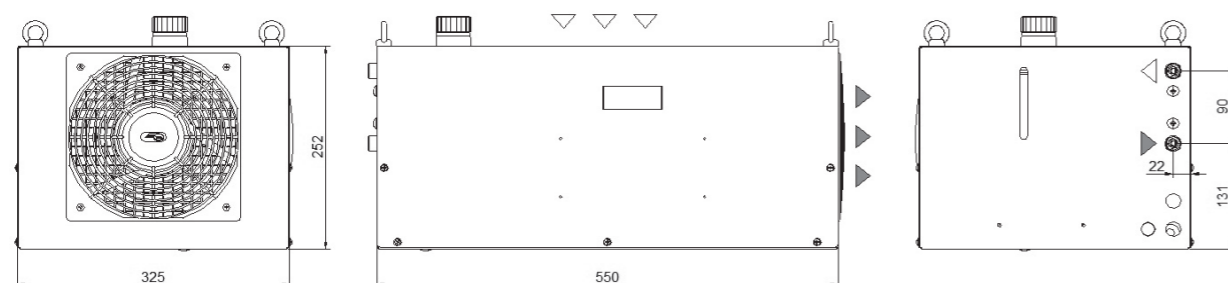

Model	SAW10		
	50Hz	60Hz	
Rated Cooling Capacity*	W	1500	1750
Max. ambient operating temp.	°C	50	
Fluid type		Water	
Power supply			
Supply voltage	V ph Hz	230V (+/-10%) 1ph 50/60Hz	
Axial Fan			
Fan type		Axial	
Quantity	no.	1 x d.200 mm	
Air flow rate	m ³ /h	700 - 820	
Standard Pump			
Pump type		Peripheral	
Quantity	no.	1	
Nominal/max fluid flow rate	l/min	9.0 - 16.0	12.0 - 18.0
Nominal available head	bar	3.2	
Max. power draw	kW	0.6	0.8
Max. current draw	A	2.7	3.3
Storage tank capacity			
Storage tank capacity	l	10	
IN/OUT liquid connections	inch	1/4"	
Net weight (approximate)***	kg	12	
Width	mm	325	
Depth	mm	550	
Height	mm	252	
Sound pressure level**	dB(A)	38	
IP rating	IP	34	

* Data relates to operation under the following conditions: outlet temp. 50°C water, ambient temperature 35°C.
 ** Sound pressure level at 50Hz, measured in a free hemispherical field at a distance of 1 m from the machine and 1.5 metres from the ground, per ISO 3746.
 *** Weights with storage tank empty and all packaging removed.
 **** The electrical data refer to cos φ = 0.8.
 ***** Permitted inlet/outlet temperature range -5 / +60°C.

Correction factors for calculating the cooling power

T water- T ambient ΔT	Fw	°C	5	10	15	20	25	30	35	40
		factor		0.38	0.67	1.00	1.30	1.67	1.91	2.32
Percentage glycol by weight	Fg	%	0	10	15	20	25	30	35	40
		factor		1.00	0.97	0.96	0.95	0.94	0.93	0.91

Cooling power = Nominal cooling power x F_o x F_a x F_t

SAW50

Water-air heat exchangers

COOLING CAPACITY

5000-5650 W



MANAGEMENT AND CONTROL
Power supply cable: 1.5 m.

PAINT/COATING
Standard colour: RAL 7035 textured.

MAIN ACCESSORIES (ref. page 189)
LE - Electrical level indicator
FP - Polyurethane air filter
TR - Digital regulation thermostat, temperature display complete with NTC sensor
RU - Castors
AV - Vibration damper supports
Others on customer request

STRUCTURE

In powder-coated steel sheet

AXIAL FAN

Aluminium axial fan, diameter 250 mm.

LIQUID CIRCUIT

Liquid circuit composed entirely of non-ferrous material in contact with the liquid to prevent contamination. Brass electric pump with 3 bar available head with thermal cut-out. Storage tank, complete with filling. Protective water flow switch.

COOLING COIL

Dual finned aluminium cooling coil with copper tubes.

Dimensions

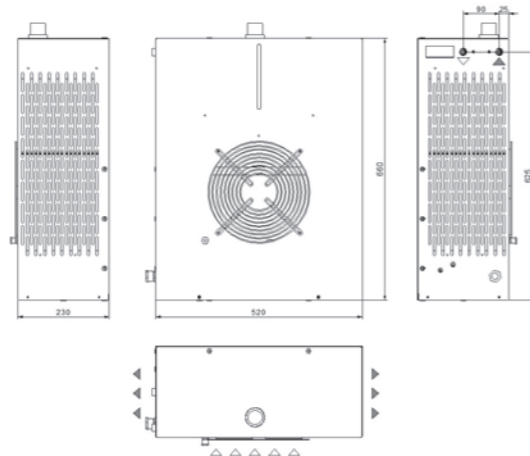

Model	SAW50		
	50Hz	60Hz	
Rated Cooling Capacity*	W	5000	5650
Max. ambient operating temp.	°C	50	
Fluid type		Water	
Power supply			
Supply voltage	V ph Hz	230V (+/-10%) 1ph 50/60Hz	
Axial Fan			
Fan type		Axial	
Quantity	no.	1 x d.250 mm	
Air flow rate	m ³ /h	1500 - 1725	
Standard Pump			
Pump type		Peripheral	
Quantity	no.	1	
Nominal/max fluid flow rate	l/min	10.0 - 16.0	13.5 - 18.0
Nominal available head	bar	2.8	
Max. power draw	kW	0.65	0.70
Max. current draw	A	3.4	4.6
Storage tank capacity			
Storage tank capacity	l	5	
IN/OUT liquid connections	inch	1/4"	
Net weight (approximate)***	kg	19	
Width	mm	520	
Depth	mm	230	
Height	mm	660	
Sound pressure level**	dB(A)	38	
IP rating	IP	34	

* Data relates to operation under the following conditions: outlet temp. 50°C water, ambient temperature 35°C.

** Sound pressure level at 50Hz, measured in a free hemispherical field at a distance of 1 m from the machine and 1.5 metres from the ground, per ISO 3746.

*** Weights with storage tank empty and all packaging removed.

**** The electrical data refer to cos φ = 0.8.

***** Permitted inlet/outlet temperature range -5 / +60°C.

Correction factors for calculating the cooling power

T water- T ambient ΔT	Fw	°C	5	10	15	20	25	30	35	40
		factor		0.38	0.67	1.00	1.30	1.67	1.91	2.32
Percentage glycol by weight	Fg	%	0	10	15	20	25	30	35	40
		factor		1.00	0.97	0.96	0.95	0.94	0.93	0.91

Cooling power = Nominal cooling power x Fo x Fa x Ft

SAWA0

Water-air heat exchangers

COOLING CAPACITY

10000 W



MANAGEMENT AND CONTROL
Power supply cable: 1.5 m.

PAINT/COATING
Standard colour: RAL 7035 textured.

MAIN ACCESSORIES (ref. page 189)
LE - Electrical level indicator
FP - Polyurethane air filter
TR - Digital regulation thermostat, temperature display complete with NTC sensor
RU - Castors
AV - Vibration damper supports
Others on customer request

STRUCTURE

In powder-coated steel sheet

AXIAL FAN

Aluminium axial fan, diameter 350 mm.

LIQUID CIRCUIT

Liquid circuit composed entirely of non-ferrous material in contact with the liquid to prevent contamination. Stainless-steel electric pump with available head of over 3.5 bar, with thermal cut-out. Storage tank, complete with filling. Protective water flow switch.

COOLING COIL

Dual finned aluminium cooling coil with copper tubes.

Dimensions

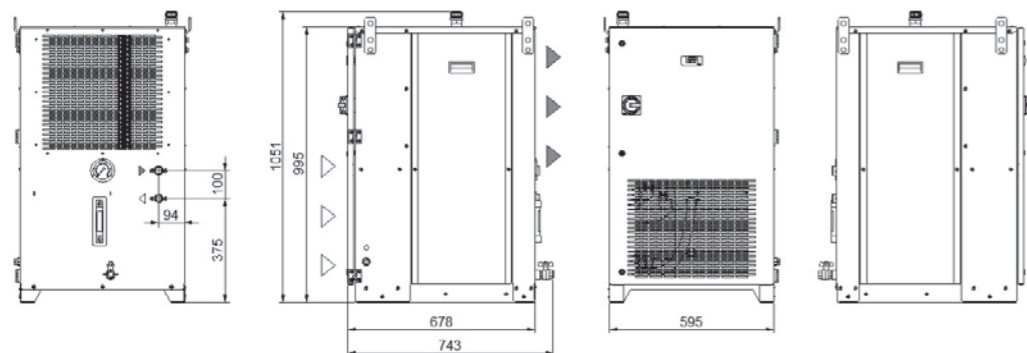

Model		SAWA0
Rated Cooling Capacity*	W	10000
Max. ambient operating temp.	°C	50
Fluid type		Water
Power supply		
Supply voltage	V ph Hz	230V (+/-10%) 1ph 50Hz
Axial Fan		
Fan type		Axial
Quantity	no.	1 x d.350 mm
Air flow rate	m ³ /h	2500 - 2850
Standard Pump		
Pump type		Peripheral
Quantity	no.	1
Nominal/max fluid flow rate	l/min	32 - 80
Nominal available head	bar	3.5
Max. power draw	kW	1.5
Max. current draw	A	6.5
Storage tank		
Storage tank capacity	l	25
IN/OUT liquid connections	inch	3/4"
Net weight (approximate)***	kg	90
Width	mm	595
Depth	mm	678
Height	mm	995
Sound pressure level**	dB(A)	38
IP rating	IP	44

* Data relates to operation under the following conditions: outlet temp. 50°C water, ambient temperature 35°C.

** Sound pressure level, measured in a free hemispherical field at a distance of 1 m from the machine and 1.5 metres from the ground, per ISO 3746.

*** Weights with storage tank empty and all packaging removed.

**** The electrical data refer to cos φ = 0.8.

***** Permitted inlet/outlet temperature range -5 / +60°C.

Correction factors for calculating the cooling power

T water- T ambient ΔT	Fw	°C	5	10	15	20	25	30	35	40
		factor	0.38	0.67	1.00	1.30	1.67	1.91	2.32	2.55
Percentage glycol by weight	Fg	%	0	10	15	20	25	30	35	40
		factor	1.00	0.97	0.96	0.95	0.94	0.93	0.91	0.90

Cooling power = Nominal cooling power x Fo x Fa x Ft

TTW

Temperature controllers

texa industries temperature controllers offer maximum reliability in a compact package for process liquid heating/cooling precision.



TTW90

Temperature controllers

HEATING CAPACITY

3000 - 6000 W



ELECTRICAL PANEL

Complete with motor starting, heating element and main disconnect switch with circuit breakers, electrical power connections with relay phase sequence control and alarm signal. The front of the panel incorporates indicator lights, green for correct operation, red for general, pump and heating element faults. Static power relays for heating temperature regulation.

MANAGEMENT AND CONTROL

Temperature control with PID heating and cooling regulation with sensor fault diagnostics and water minimum and maximum temperature control. RS485 serial communication on request.

MAIN ACCESSORIES (on request, ref. page 191)

- VO - Stop valves
- RU - Castors
- External temperature sensor kit
- Non-standard paint/coating
- Satin AISI 304 stainless steel framework
- Non-standard supply voltages possible

STRUCTURE

In powder-coated steel sheet, RAL 7035 textured finish. Easily removed panels

LIQUID CIRCUIT

DIRECT cooling circuit (high-efficiency INDIRECT on request with plate heat exchanger). ON-OFF cooling solenoid valve, or modulating valve on request. Stainless-steel centrifugal pump. Reinforced heating elements with large heat-exchange area.

Flow switch, minimum pressure switch and mechanical maximum pressure valve are installed to protect the fluid circuit.

Model		TTW90	
Type of heating/cooling		Direct	
Stepping	%	0-100	
Field of operation	°C	+5 - +95	
Temperature regulation precision	°C	+/-0.5	
Control action	-	PID	
Heating section			
Power	kW	3.0	6.0
Maximum temperature	°C	95	
Type	-	Electric	
Control	-	SSR	
Pump			
Pump type	-	Centrifugal	
Min/max fluid flow rate	l/min	36.0	60.0
Nominal head	bar	5.4	3.6
Max. power draw	kW	0.9	
Max. current draw	A	1.8	
Maximum pressure	bar	10	
Electrical specifications			
Supply voltage	V ph Hz	400V (+/-10%) 3ph 50Hz	
Secondary supply voltage	V	24 V AC	
Max. power draw	kW	3.8	6.8
Max. current draw	A	7.2	12
Dimensions			
Total volume	l	3.6	5.4
IN/OUT liquid connections	inch	3/4"	
IN/OUT cooling connections	inch	3/4"	
Net weight (approximate)*	kg	61	65
Width	mm	304	
Depth	mm	795	
Height	mm	550	
Noise**	dB(A)	50	
Colour	-	RAL7035	
IP rating	IP	44	

* Weight without pallets, packaging and drained of fluid.

** Sound pressure level, measured in a free hemispherical field at a distance of 1 m from the machine and 1.5 metres from the ground, per ISO 3746.

*** The electrical data refer to $\cos \phi = 0.8$.

Dimensions

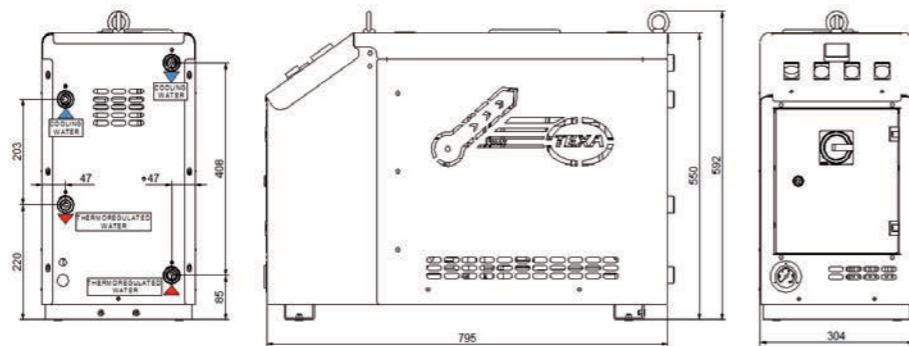

TTW95

Temperature controllers

HEATING CAPACITY

3000 - 6000 - 9000 - 12000 W



ELECTRICAL PANEL

Complete with motor starting, heating element and main disconnect switch with circuit breakers, electrical power connections with relay phase sequence control and alarm signal. The front of the panel incorporates indicator lights, green for correct operation, red for general, pump and heating element faults. Static power relays for heating temperature regulation.

MANAGEMENT AND CONTROL

Temperature control with PID heating and cooling regulation with sensor fault diagnostics and water minimum and maximum temperature control. RS485 serial communication on request.

MAIN ACCESSORIES (on request, ref. page 191)

- VO - Stop valves
- RU - Castors
- External temperature sensor kit
- Non-standard paint/coating
- Satin AISI 304 stainless steel framework
- Non-standard supply voltages possible

STRUCTURE

In powder-coated steel sheet, RAL 7035 textured finish. Easily removed panels

LIQUID CIRCUIT

DIRECT cooling circuit (high-efficiency INDIRECT on request with plate heat exchanger). ON-OFF cooling solenoid valve, or modulating valve on request. Stainless-steel centrifugal pump. Reinforced heating elements with large heat-exchange area.

Flow switch, minimum pressure switch and mechanical maximum pressure valve are installed to protect the fluid circuit.

Model	TTW95				
Type of heating/cooling	Direct				
Stepping	%	0-100			
Field of operation	°C	+5 - +95			
Temperature regulation precision	°C	+/-0.5			
Control action	-	PID			
Heating section					
Power	kW	3.0	6.0	9.0	12.0
Maximum temperature	°C	95			
Type	-	Electric			
Control	-	SSR			
Pump					
Pump type	-	Centrifugal			
Min/max fluid flow rate	l/min	36.0		60.0	
Nominal head	bar	5.4		3.6	
Max. power draw	kW	0.9			
Max. current draw	A	1.8			
Maximum pressure	bar	10			
Electrical specifications					
Supply voltage	V ph Hz	400V (+/-10%) 3ph 50Hz			
Secondary supply voltage	V	24 V AC			
Max. power draw	kW	3.8	6.8	9.8	12.8
Max. current draw	A	7.2	12.0	16.8	21.6
Dimensions					
Total volume	l	3.6	5.4	7.2	9.0
IN/OUT liquid connections	inch	1"			
IN/OUT cooling connections	inch	1"			
Net weight (approximate)*	kg	75	80	90	95
Width	mm	304			
Depth	mm	795			
Height	mm	730			
Noise**	dB(A)	50			
Colour	-	RAL7035			
IP rating	IP	44			

* Weight without pallets, packaging and drained of fluid.
 ** Sound pressure level, measured in a free hemispherical field at a distance of 1 m from the machine and 1.5 metres from the ground, per ISO 3746.
 *** The electrical data refer to $\cos \phi = 0.8$.

Dimensions

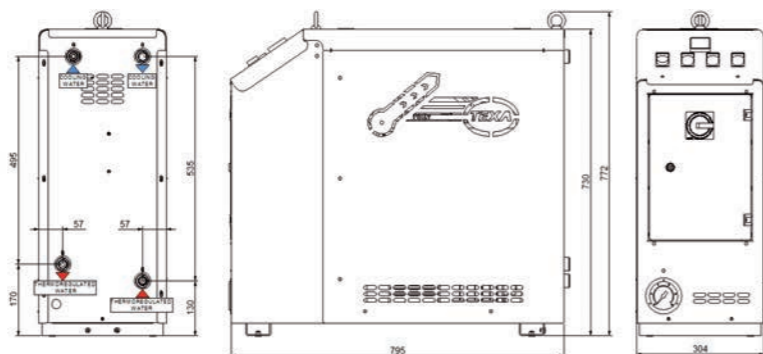

TEXA FLUID

Chemical additives for industrial cooling circuits

INTRODUCTION

texa industries, thanks to its experience in manufacturing industrial cooling systems, has developed multiple liquid solutions for industrial systems to be used with or without mixing with water. Whenever water is used as the heat transfer medium in circuits, the use of these liquid solutions offers complete protection of the liquid system, also guaranteeing that the heat transfer capacity is maintained.

These products have been designed to limit the onset of problems such as corrosion, the formation of deposits and scale, bacteriological phenomena, reduction in performance, increases in maintenance costs, unexpected stoppages and reduction of the average lifespan of the systems. The phenomenon which causes the greatest number of problems in circuits is CORROSION. The water present in the systems tends to form scale deposits and bacterial slime, and above all encourages corrosion caused by the metal being attacked by the oxygen it contains. The use of high-purity water (demineralised, RO purified and in some cases softened) prevents the formation of scale but significantly increases corrosion issues. The main causes of corrosion are:

OXIDATION of the metals due to the oxygen dissolved in the water

ACID produced by the breakdown of glycol over time

texa industries therefore decided to develop multiple solutions to meet customer requirements in order to prevent damage to industrial systems, particularly closed circuits (at atmospheric and other pressures).

WARNING: For detailed information on the toxicity and other safety factors relating to any type of fluid, refer to the MSDS provided by **texa industries**.



TEXA FLUID 903-TX

Product code: C15001209- 25 kg can
C15002650- 10 kg can

This is a liquid solution based on 93% ethylene glycol with the addition of inhibitors and biocides. The product is compatible with all the most common metals (iron, steel, copper and its alloys, aluminium and its alloys), as well as plastic and rubber. Designed to protect liquid circuits in industrial machines, machine tools and all those systems where the recirculation of cold or hot water in multi-metal circuits is necessary.

It is formulated with substances which provide three key actions to protect the system:

ANTIFREEZE ACTION: prevents the formation of ice at temperatures around zero

CORROSION INHIBITION: prevents corrosion by forming a protective film on metal surfaces

BIOCIDAL ACTION: inhibits growth of fungi, moulds and bacteria, preventing slime build-up.

Do not mix with softened, demineralised and RO purified water.



TEXA FLUID 903-TX-MIXED

Product code: C15001218- 25 kg can

This is a liquid solution based on 30% ethylene glycol with the addition of inhibitors and biocides, and mixed with 70 % water. Retains the same chemical characteristics as 903-TX.



TEXA FLUID BIOCIDE-ALGICIDE FLUID

Product code: C15003950- 25 kg can
C15003930- 1 kg can

This is a biocide formulation based on isothiazolinone with an excellent algicidal and biomass dispersion action. It is used to control biological pollution in open recirculated or similar cooling circuits. It penetrates the biological masses thanks to its effective dispersive action, guaranteeing the best possible cleaning of the heat exchange surfaces. This liquid, as well as having a powerful biocidal and algicidal effect, also has low levels of toxicity. The use of this liquid is particularly recommended for softened, demineralised and RO purified water (laser applications).



TEXA FLUID CORROSION INHIBITOR

Product code: C15003949- 25 kg can
C15003929- 1 kg can

This is a highly ecological formulation which prevents corrosion in closed recirculated hot and cold water circuits. The presence of a strong inorganic anodic inhibitor, which is ecologically compatible, together with organic inhibitors and polymer dispersants, provides excellent protection from corrosion for ferrous and cupric metals and alloys and excellent cleaning of the heat exchange surfaces, preventing the formation of any kind of deposits. Also compatible with non-metallic components.



TEXA FLUID FOOD

Product code: C15004334- 25 kg can

This is a multifunctional diathermic fluid based on FDA approved inhibited mono ethylene glycol. Recommended for use as a diathermic fluid whenever accidental food contact is possible. Not suitable for use as a direct food component or additive. It is compatible with most other diathermic fluids based on mono ethylene glycol. Exclusive use of this product is recommended for optimum protection against corrosion. It must be mixed only with low hardness distilled water. It protects metals and alloys used in systems against all forms of corrosion. The combination of low toxicity and FDA approved ingredients with a high level of corrosion protection makes this product unique on the market. Competing products often provide insufficient protection for aluminium and copper. Given the frequent use of copper in the food industry, the excellent protection that TEXA FLUID FOOD provides for it makes it a particularly suitable product.



TECHNICAL HELPDESK

A telephone support service during the quotation and installation phase, which is always free and available to our customers.

SERVICE NETWORK

Availability, courtesy and efficiency

Our customers benefit from a wide network composed of engineers and technicians which offers an efficient support service around the world.



AFTER-SALES NETWORK

An international support network composed of specialised companies and qualified engineers provides technical support and original spare parts across five continents.



MAINTENANCE & SPARE PARTS

Original spare parts always available directly from our headquarters to ensure reliability and effectiveness.

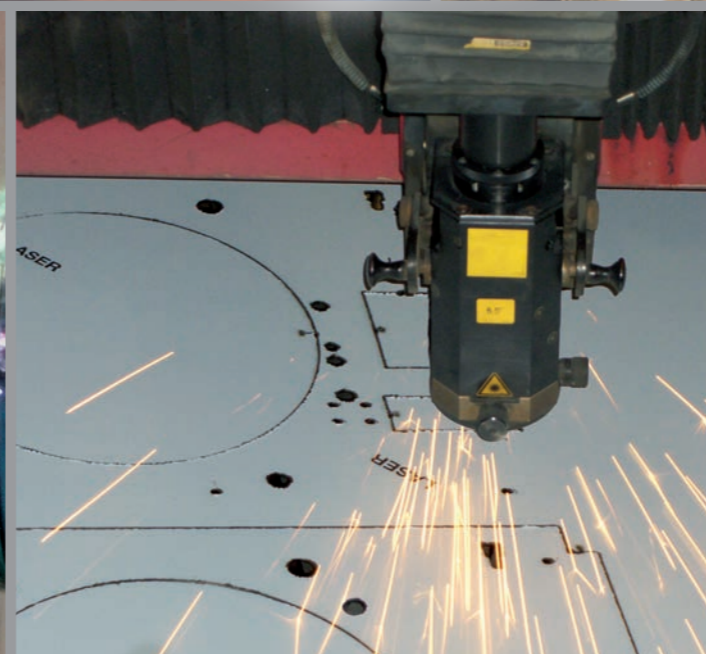
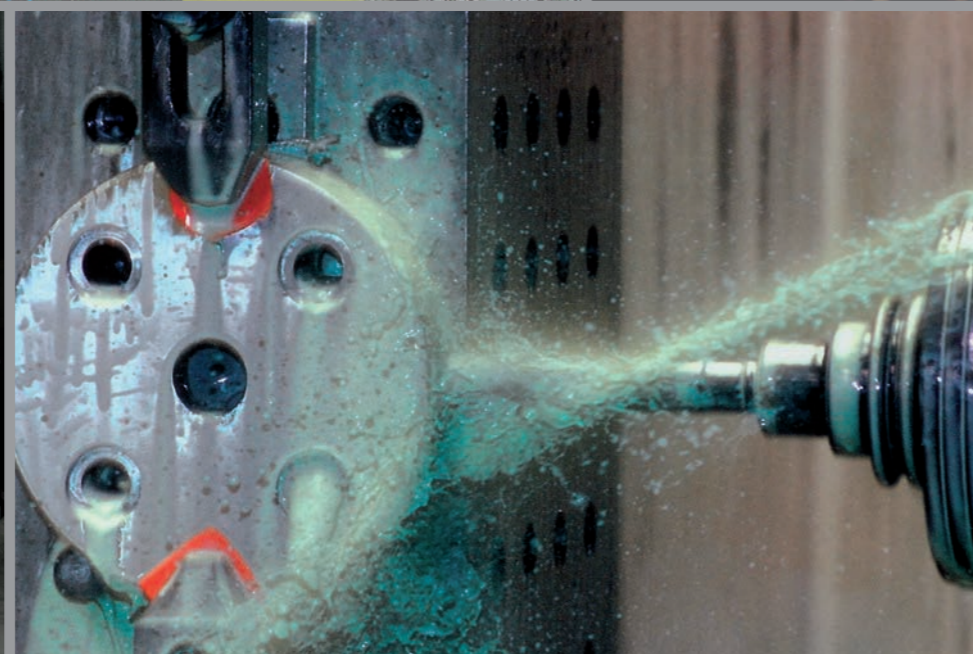
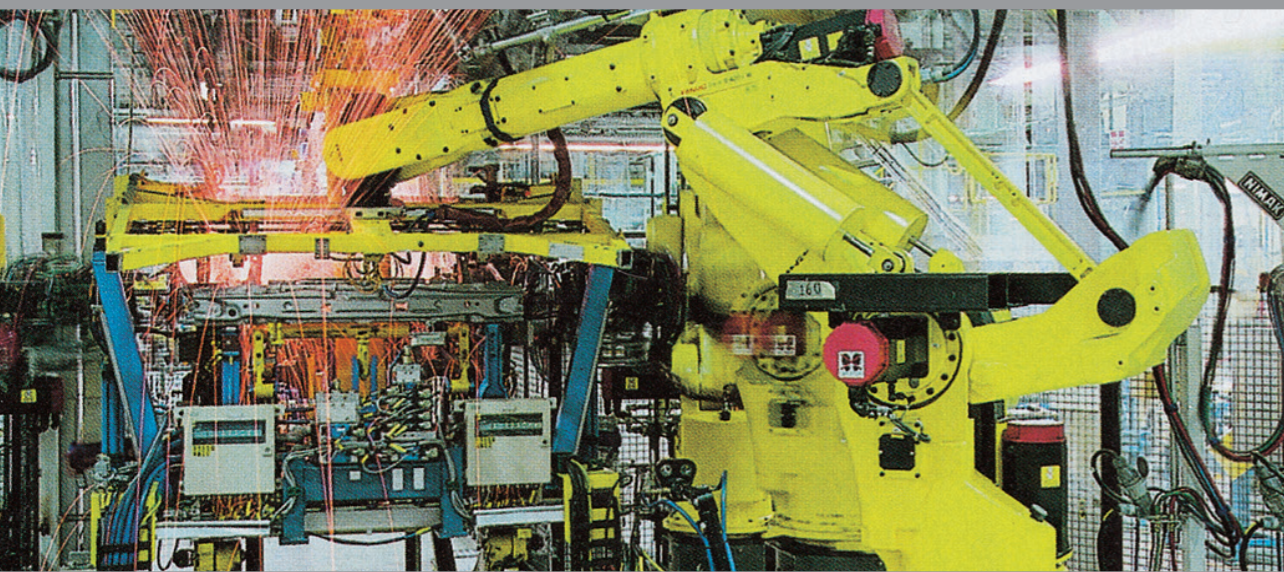
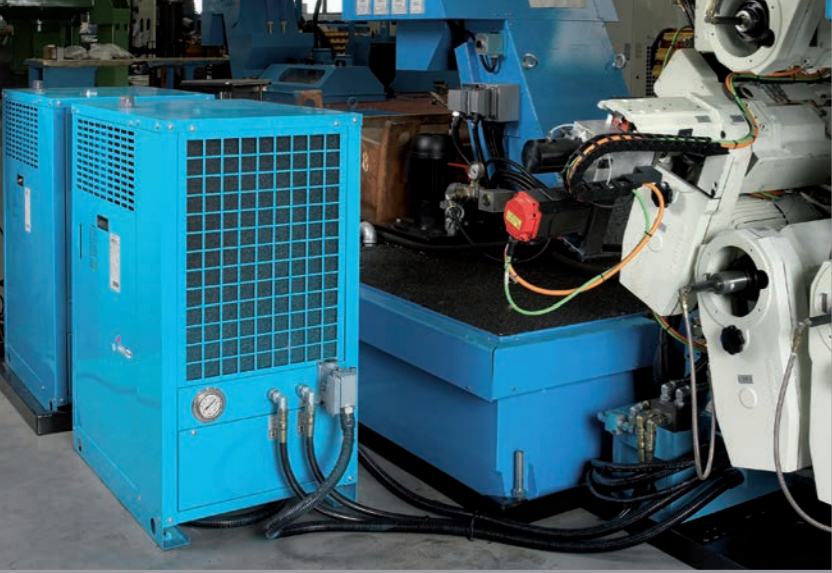

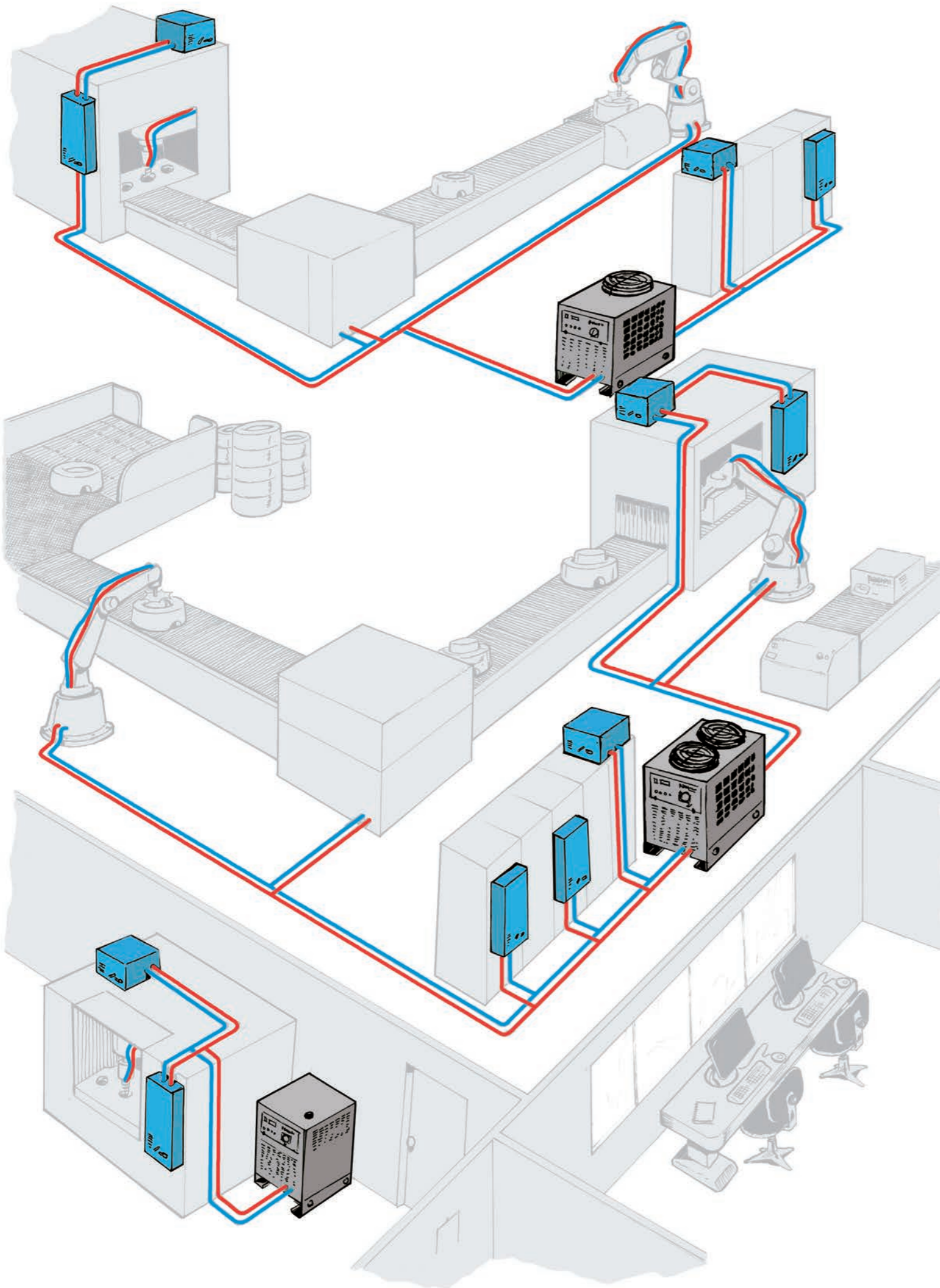



www.texaindustries.com



info@texaindustries.com



service@texaindustries.com



texa industries s.r.l. PEGOGNAGA - MANTOVA - ITALY - Strada Cà Bruciata, 5
Tel. +39 0376-554511 - FAX +39 0376-558606